



Micro Commercial Components



Micro Commercial Components  
 20736 Marilla Street Chatsworth  
 CA 91311  
 Phone: (818) 701-4933  
 Fax: (818) 701-4933

**2SD1899-M**  
**2SD1899-L**  
**2SD1899-K**

## Features

- Halogen free available upon request by adding suffix "-HF"
- Lead Free Finish/Rohs Compliant ("P" Suffix designates RoHS Compliant. See ordering information)
- Capable of 1.0Watts of Power Dissipation.
- Collector-current 3.0A
- Collector-base Voltage 60V
- Operating and storage junction temperature range:-55°C to +150°C
- Epoxy meets UL 94 V-0 flammability rating
- Moisture Sensitivity Level 1

### Electrical Characteristics @ 25°C Unless Otherwise Specified

Symbol	Parameter	Min	Max	Units
--------	-----------	-----	-----	-------

#### OFF CHARACTERISTICS

$V_{(BR)CEO}$	Collector-Emitter Breakdown Voltage ( $I_C=1.0mA$ , $I_B=0$ )	60		Vdc
$V_{(BR)CBO}$	Collector-Base Breakdown Voltage ( $I_C=100\mu A$ , $I_E=0$ )	60		Vdc
$V_{(BR)EBO}$	Emitter-Base Breakdown Voltage ( $I_E=100\mu A$ , $I_C=0$ )	7		Vdc
$I_{CBO}$	Collector Cutoff Current ( $V_{CB}=60Vdc$ , $I_E=0A$ )		10	$\mu A$
$I_{EBO}$	Emitter Cutoff Current ( $V_{EB}=7.0Vdc$ , $I_C=0A$ )		10	$\mu A$

#### ON CHARACTERISTICS

$h_{FE(1)}$	DC Current Gain* ( $I_C=600mA$ , $V_{CE}=2.0Vdc$ )	100	400	
$V_{CE(sat)}$	Collector-Emitter Saturation Voltage ( $I_C=1500mA$ , $I_B=150mA$ )		0.25	Vdc
$V_{BE(sat)}$	Base-Emitter Saturation Voltage ( $I_C=1500mA$ , $I_B=150mA$ )		1.2	Vdc

#### SMALL-SIGNAL CHARACTERISTICS

$f_T$	Transistor Frequency ( $I_C=1500mA$ , $V_{CE}=5Vdc$ )	120(Typ)		MHz
$C_{OB}$	Collector Output Capacitance ( $V_{CB}=10Vdc$ , $I_E=0$ , $f=1MHz$ )	30(typ)		pF

#### CLASSIFICATION OF $h_{FE(1)}$

Rank	M	L	K
Range	100-200	160-320	200-400

**NPN Silicon**  
**Epitaxial Transistor**

### DPAK

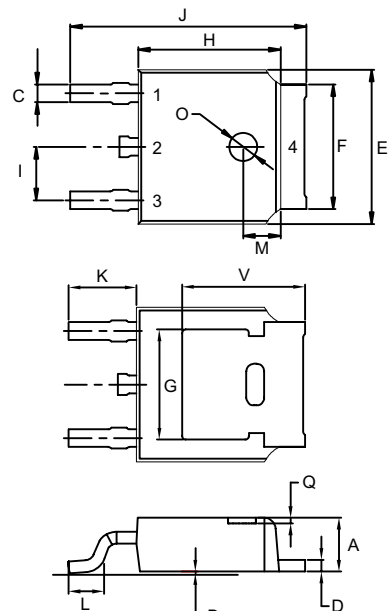

PIN 1. BASE  
 PIN 2.4 COLLECTOR  
 PIN 3. EMITTER

#### DIMENSIONS

DIM	INCHES		MM		NOTE
	MIN	MAX	MIN	MAX	
A	0.087	0.094	2.20	2.40	
B	0.000	0.005	0.00	0.13	
C	0.026	0.034	0.66	0.86	
D	0.018	0.023	0.46	0.58	
E	0.256	0.264	6.50	6.70	
F	0.201	0.215	5.10	5.46	
G	0.190		4.83		
H	0.236	0.244	6.00	6.20	
I	0.086	0.094	2.18	2.39	
J	0.386	0.409	9.80	10.40	
K	0.114		2.90		
L	0.055	0.067	1.40	1.70	
M	0.063		1.60		
O	0.043	0.051	1.10	1.30	
Q	0.000	0.012	0.00	0.30	
V	0.211		5.35		

## Typical Characteristics

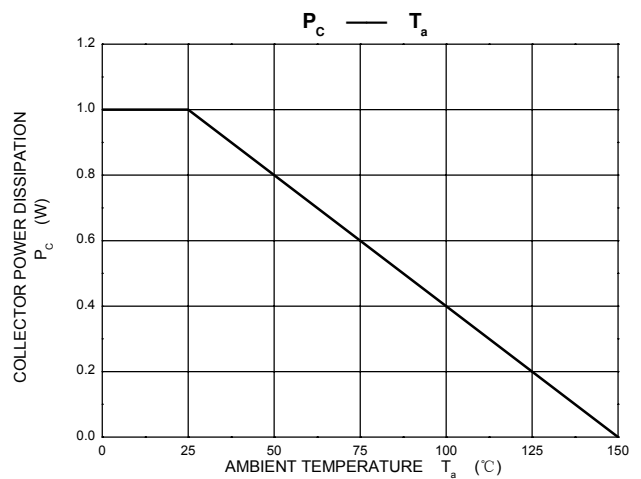
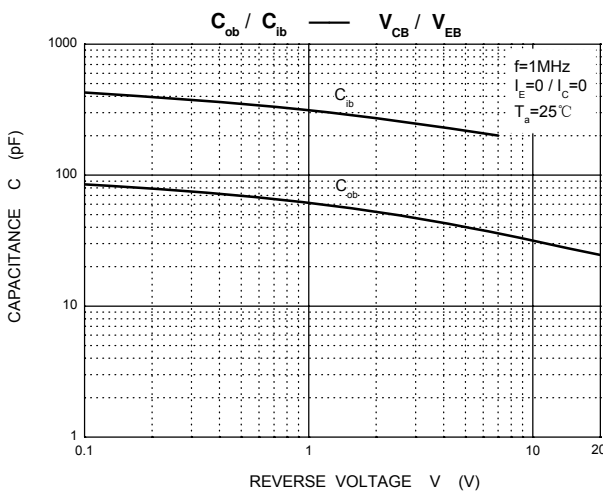
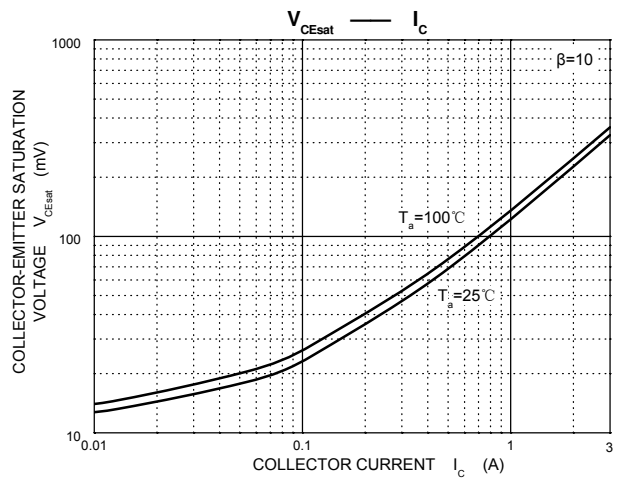
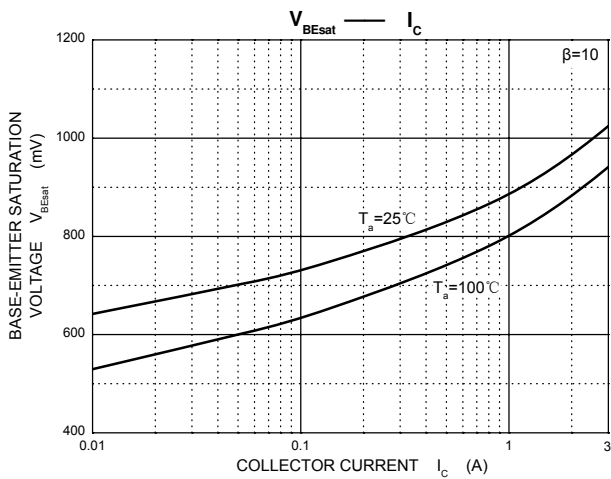
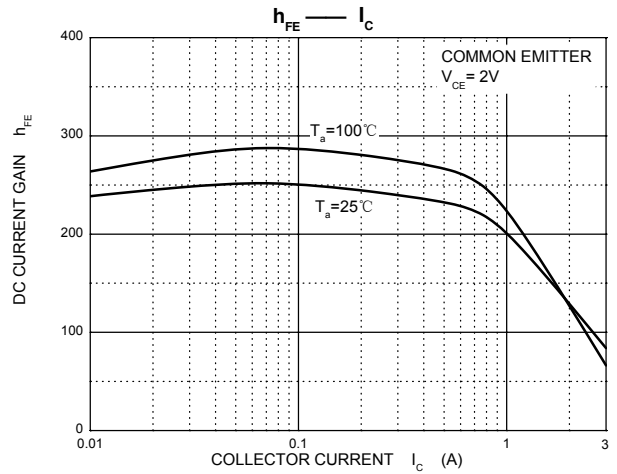
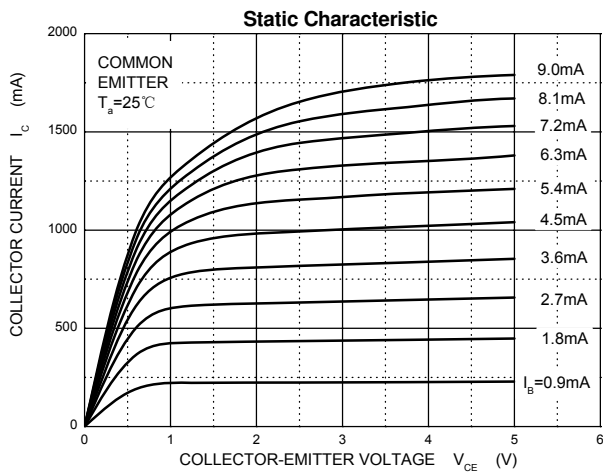



Micro Commercial Components

Ordering Information :

Device	Packing
Part Number-TP	Tape&Reel: 2.5Kpcs/Reel

Note : Adding "-HF" suffix for halogen free, eg. Part Number-TP-HF

\*\*\*IMPORTANT NOTICE\*\*\*

Micro Commercial Components Corp. reserves the right to make changes without further notice to any product herein to make corrections, modifications, enhancements, improvements, or other changes. Micro Commercial Components Corp. does not assume any liability arising out of the application or use of any product described herein; neither does it convey any license under its patent rights, nor the rights of others. The user of products in such applications shall assume all risks of such use and will agree to hold Micro Commercial Components Corp. and all the companies whose products are represented on our website, harmless against all damages.

\*\*\*LIFE SUPPORT\*\*\*

MCC's products are not authorized for use as critical components in life support devices or systems without the express written approval of Micro Commercial Components Corporation.

\*\*\*CUSTOMER AWARENESS\*\*\*

Counterfeiting of semiconductor parts is a growing problem in the industry. Micro Commercial Components (MCC) is taking strong measures to protect ourselves and our customers from the proliferation of counterfeit parts. MCC strongly encourages customers to purchase MCC parts either directly from MCC or from Authorized MCC Distributors who are listed by country on our web page cited below. Products customers buy either from MCC directly or from Authorized MCC Distributors are genuine parts, have full traceability, meet MCC's quality standards for handling and storage. MCC will not provide any warranty coverage or other assistance for parts bought from Unauthorized Sources. MCC is committed to combat this global problem and encourage our customers to do their part in stopping this practice by buying direct or from authorized distributors.