

Wideband Distributed Amplifier

100 kHz - 50 GHz



MAAM-011238

Rev. V6

Features

- Gain: 14 dB @ 6 V, 30 GHz
- P1dB: 17 dBm @ 6 V, 30 GHz
- P3dB: 18.5 dBm @ 6 V, 30 GHz
- Integrated Power Detector
- Gain control with only positive bias voltages
- 50 Ω Input and Output Match
- Bias Voltage: $V_{DD} = 4 - 6$ V
- Bias Current: $I_{DSQ} = 125 - 150$ mA
- 5 mm SMT Package
- RoHS* Compliant

Applications

- Instrumentation and Communication Systems

Description

MAAM-011238 is an easy-to-use, wideband amplifier that operates from 100 kHz to 50 GHz. The amplifier provides 14 dB gain, 5 dB noise figure and 18.5 dBm of P3dB output power @ 30 GHz. It is matched to 50 Ω with typical return loss of 12 dB. The amplifier requires only positive bias voltages and would typically be operated at 6 V and 135 mA.

MAAM-011238 is suitable for a wide range of applications in instrumentation and communication systems.

This part is also available as a bare die. Refer to datasheet MAAM-011238-DIE.

Ordering Information¹

Part Number	Package
MAAM-011238-TR0100	100 part reel
MAAM-011238-TR0500	500 part reel
MAAM-011238-SB1	Sample Board

1. Reference Application Note M513 for reel size information.

Functional Schematic

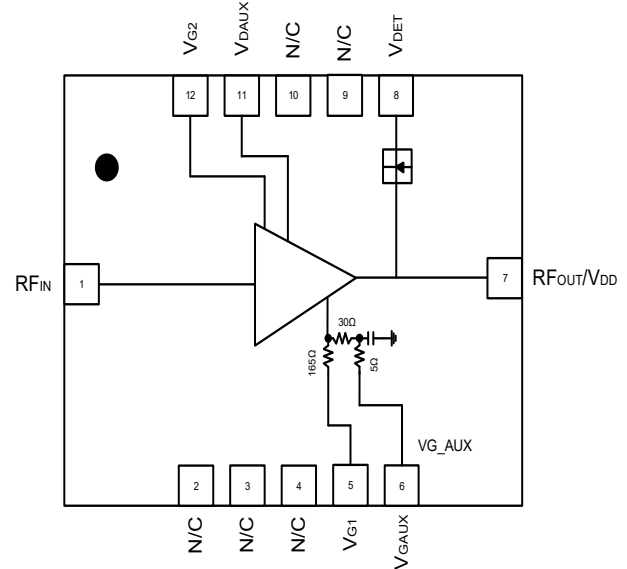

Pin Configuration^{2,3,4}

Pin #	Pin Name	Description
1	RFIN	RF Input / Gate Voltage
5	VG1	Gate Voltage 1
6	VGAUX	Auxiliary Gate Voltage
7	RFOUT/VDD	RF Output / Drain Voltage
8	VDET	Detector Voltage
11	VDAUX	Auxiliary Drain Voltage
12	VG2	Gate Voltage 2
2, 3, 4, 9, 10	N/C	No Connection

2. MACOM recommends connecting all no connection (N/C) pins to ground.
3. The exposed pad centered on the package bottom must be connected to RF, DC and thermal ground.
4. Internal to package are 100 pF decoupling capacitors on pins 5, 6, 8, 11, 12.

* Restrictions on Hazardous Substances, compliant to current RoHS EU directive.

Wideband Distributed Amplifier

100 kHz - 50 GHz



MAAM-011238

Rev. V6

Electrical Specifications^{5,6,7}: $T_A = 25\text{ }^\circ\text{C}$, $V_{DD} = 6\text{ V}$, $I_{DSQ} = 135\text{ mA}$, $Z_0 = 50\text{ }\Omega$

Parameter	Test Conditions	Units	Min.	Typ.	Max.
Gain	0.01 - 10 GHz	dB	13.0	16.0	—
	10 - 20 GHz		12.5	15.0	
	20 - 30 GHz		11.0	14.0	
	30 - 40 GHz		11.0	13.0	
	40 - 43.5 GHz		10.0	12.5	
	43.5 - 50 GHz		—	12.5	
Noise Figure	2 - 10 GHz	dB	—	5.0	—
	10 - 20 GHz		—	4.0	
	20 - 30 GHz		—	5.0	
	30 - 40 GHz		—	7.0	
	40 - 43.5 GHz		—	6.5	
	43.5 - 50 GHz		—	9.0	
Input Return Loss	0.01 - 20 GHz	dB	—	20.0	—
	20 - 30 GHz		—	12.0	
	30 - 40 GHz		—	10.0	
	40 - 43.5 GHz		—	11.0	
	43.5 - 50 GHz		—	10.5	
Output Return Loss	0.01 - 10 GHz	dB	—	19.5	—
	10 - 20 GHz		—	20.0	
	20 - 30 GHz		—	13.0	
	30 - 40 GHz		—	9.5	
	40 - 43.5 GHz		—	10.0	
$P_{OUT} @ P_{IN} = 11\text{ dBm}$	0.1 - 10 GHz	dBm	20.0	21.5	—
	10 - 20 GHz		19.5	21.0	
	20 - 30 GHz		18.0	19.5	
	30 - 40 GHz		17.0	19.0	
	40 - 43.5 GHz		17.0	18.7	
P1dB	0.1 - 20 GHz	dBm	—	18.0	—
	20 - 30 GHz		—	17.0	
	30 - 40 GHz		—	16.0	
	40 - 43.5 GHz		—	15.5	
	43.5 - 50 GHz		—	15.0	
P3dB	0.1 - 10 GHz	dBm	—	20.5	—
	10 - 20 GHz		—	20.0	
	20 - 30 GHz		—	18.5	
	30 - 40 GHz		—	18.0	
	40 - 50 GHz		—	17.0	
Output IP3	0.01 - 10 GHz	dBm	—	28.0	—
	10 - 20 GHz		—	29.0	
	20 - 30 GHz		—	27.0	
	30 - 40 GHz		—	25.0	
	40 - 43.5 GHz		—	24.0	
	43.5 - 50 GHz		—	20.5	
Drain Current	Quiescent bias	mA	—	135	—

5. Set I_{DSQ} according to bias procedures in page 3.

6. Graphs in datasheet use test conditions shown unless otherwise stated.

7. All data measured with package assembled as per the Assembly Guideline.

2

MACOM Technology Solutions Inc. (MACOM) and its affiliates reserve the right to make changes to the product(s) or information contained herein without notice. Visit www.macom.com for additional data sheets and product information.

For further information and support please visit:
<https://www.macom.com/support>

DC-0017451

Wideband Distributed Amplifier

100 kHz - 50 GHz



MAAM-011238

Rev. V6

Operating Conditions

One of the recommended biasing conditions is $V_{DD} = 6\text{ V}$, $I_{DSQ} = 135\text{ mA}$. (controlled with V_{G1}). I_{DSQ} is set by adjusting V_{G1} after correctly setting V_{DD} . (Refer to turn on sequence.)

Device biasing is achieved with the use of an external DC block on the input and a bias tee. The required V_{DD} is applied at RF_{OUT}/V_{DD} through the bias tee and V_{G1} is set to provide the required current bias (I_{DSQ}). This provides wide band performance of 40 MHz - 50 GHz. (depending on the bandwidth of the bias tee)

For low frequency extension, the addition of $1\text{ }\mu\text{F}$ and $0.01\text{ }\mu\text{F}$ bypass capacitors on both V_{G1} and V_{DAUX} , will improve the frequency of operation down to 100 kHz. These capacitors should be positioned as close to the device as possible.

Dynamic gain control is available when operating in the linear gain region through the application of 0 to 1.6 V to V_{G2} .

Data in this datasheet was measured using bypass capacitors on V_{G1} and V_{DAUX} .

The evaluation board is configured as shown in the Application Schematic with a direct connection to V_{G1} for lower gate voltage, typically 0.65 V with I_{G1} of 1 mA.

As an alternate configuration, V_{G1} can be shifted to $>3\text{ V}$ by grounding V_{GAUX} . Note that this will increase I_{G1} to 21 mA. This is not a typical configuration and is available only for legacy applications that require $V_{G1} > 3\text{ V}$.

Operating the MAAM-011238

Turn-on

1. Apply V_{G1} to 0 V.
2. Apply V_{DD} to 6 V.
3. Set I_{DSQ} by adjusting V_{G1} more positive. (typically 0.65 V for $I_{DSQ} = 135\text{ mA}$).
4. Apply RF_{IN} signal.

Turn-off

1. Remove RF_{IN} signal.
2. Decrease V_{G1} to 0 V.
3. Decrease V_{DD} to 0 V.

Application Schematic

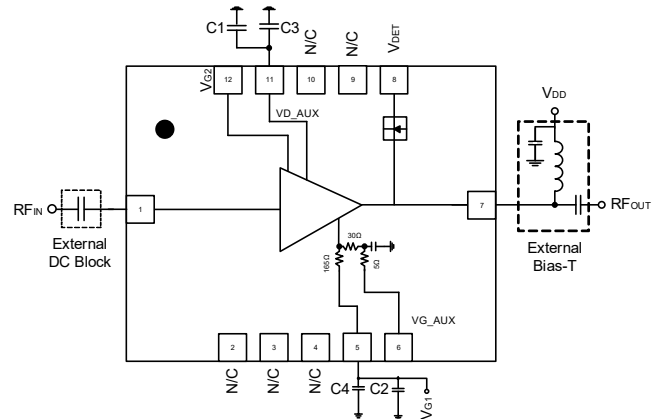

Component List

Part	Value	Case Style
C1, C2	1 μF	0603
C3, C4	0.01 μF	0402

Absolute Maximum Ratings^{8,9}

Parameter	Absolute Maximum
Input Power	16 dBm
Drain Supply Voltage	8 V
Junction Temperature ^{10,11}	+150°C
Operating Temperature	-40°C to +85°C
Storage Temperature	-65°C to +150°C

8. Exceeding any one or combination of these limits may cause permanent damage to this device.
9. MACOM does not recommend sustained operation near these survivability limits.
10. Operating at nominal conditions with $T_J \leq +150^\circ\text{C}$ will ensure $MTTF > 1 \times 10^6$ hours.
11. Junction Temperature (T_J) = $T_A + \theta_{JC} * ((V * I) - (P_{OUT} - P_{IN}))$
Typical thermal resistance (θ_{JC}) = 26.3°C/W.
For $T_A = +85^\circ\text{C}$,
 $T_J = 105^\circ\text{C}$ at $V = 6\text{ V}$, $I = 0.135\text{ A}$

Wideband Distributed Amplifier

100 kHz - 50 GHz



MAAM-011238

Rev. V6

Typical Performance Curves: $V_{DD} = 6\text{ V}$, $I_{DSQ} = 135\text{ mA}$, $T_A = +25^\circ\text{C}$

Gain

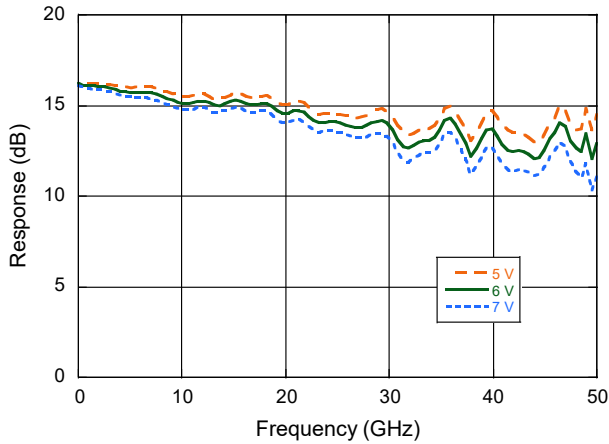

Reverse Isolation

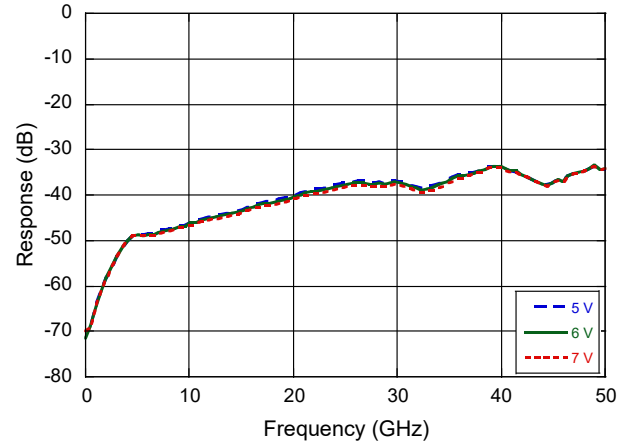

Input Return Loss

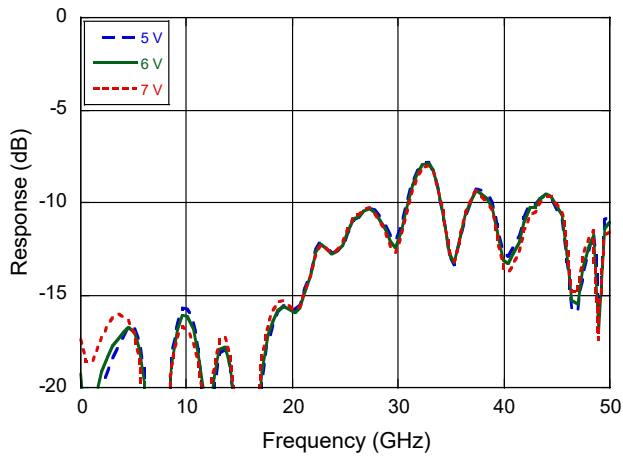

Output Return Loss

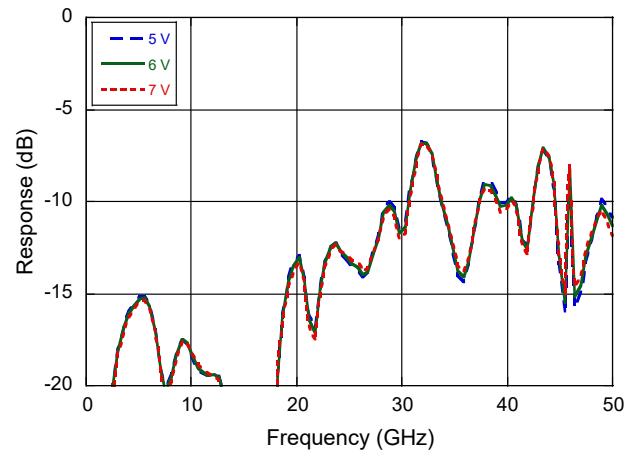

Wideband Distributed Amplifier

100 kHz - 50 GHz



MAAM-011238

Rev. V6

Typical Performance Curves: $V_{DD} = 6\text{ V}$, $I_{DSQ} = 135\text{ mA}$

Gain

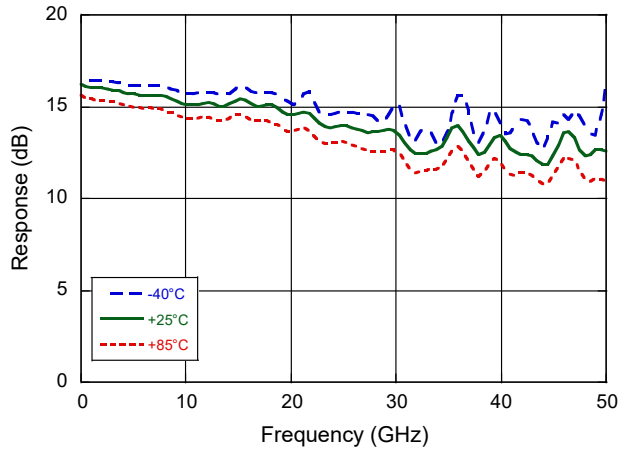

Reverse Isolation

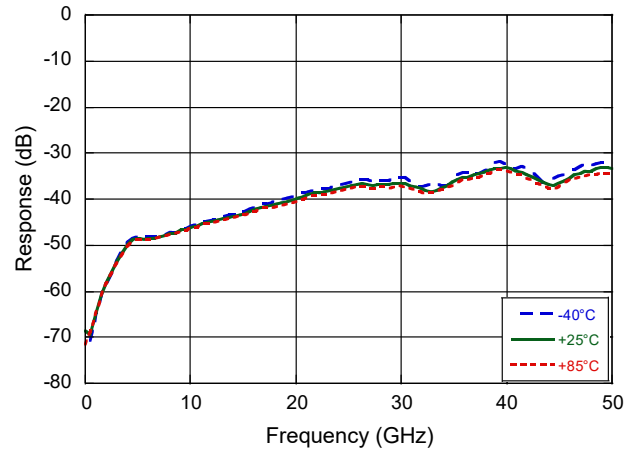

Input Return Loss

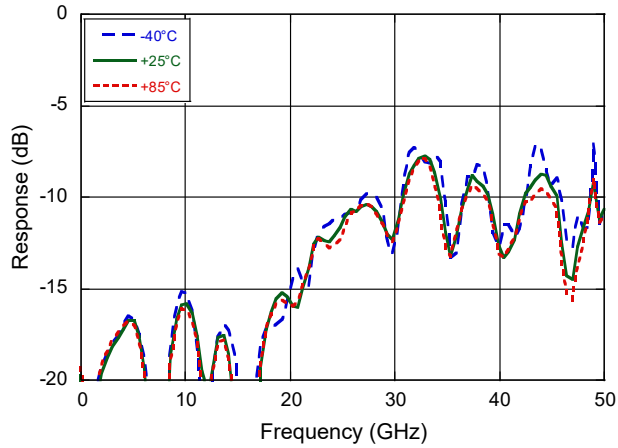

Output Return Loss

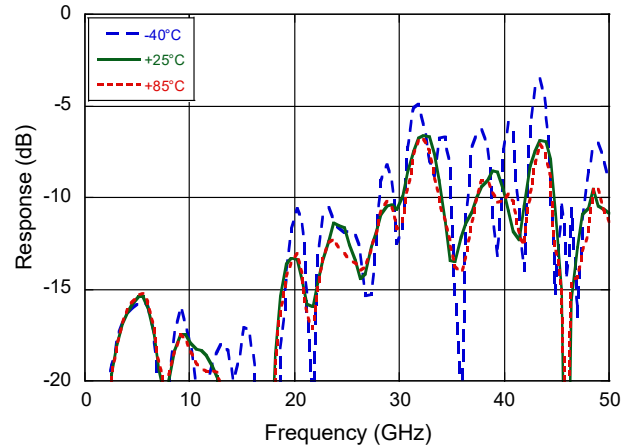

Wideband Distributed Amplifier

100 kHz - 50 GHz



MAAM-011238

Rev. V6

Typical Performance Curves: $V_{DD} = 6\text{ V}$, $I_{DSQ} = 135\text{ mA}$, $T_A = +25^\circ\text{C}$

Output P1dB

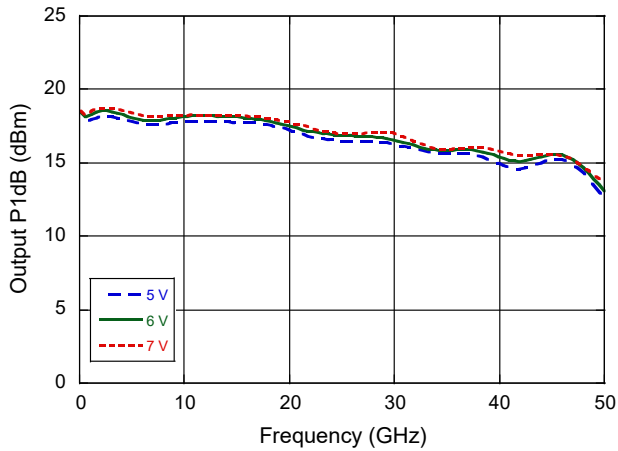

Output P3dB

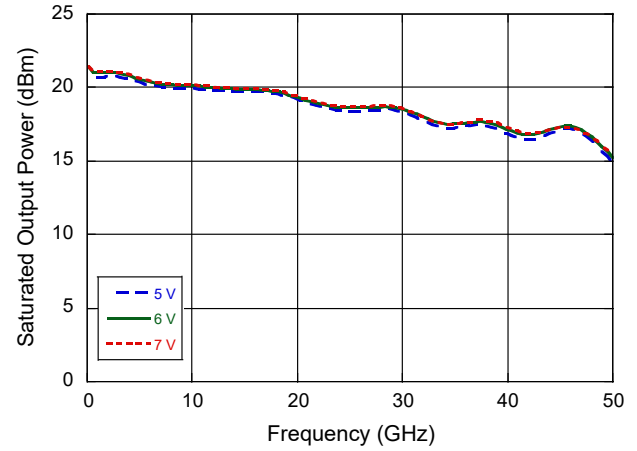

Noise Figure

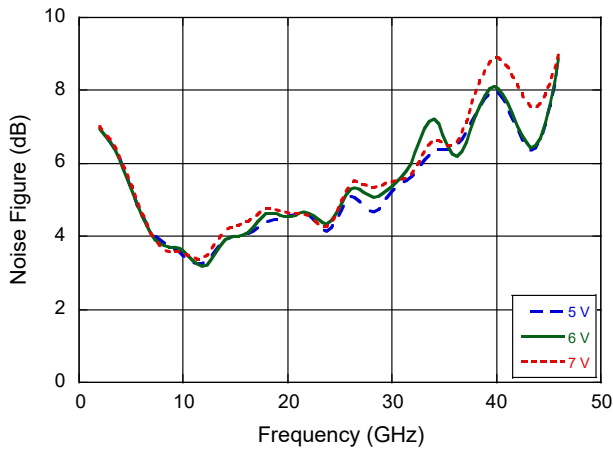

OIP3

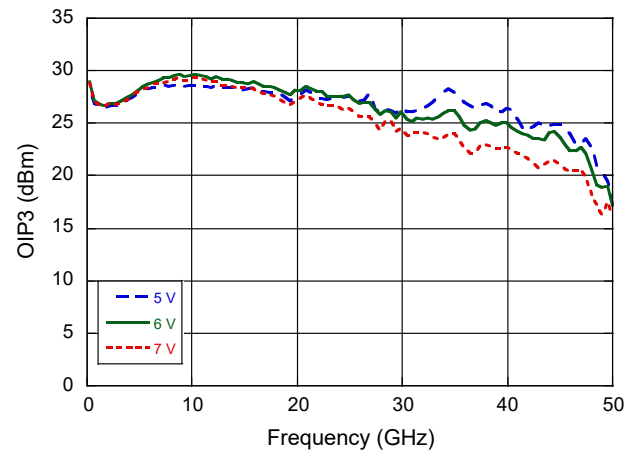

Wideband Distributed Amplifier

100 kHz - 50 GHz



MAAM-011238

Rev. V6

Typical Performance Curves: $V_D = 6\text{ V}$, $I_D = 135\text{ mA}$

Output P1dB

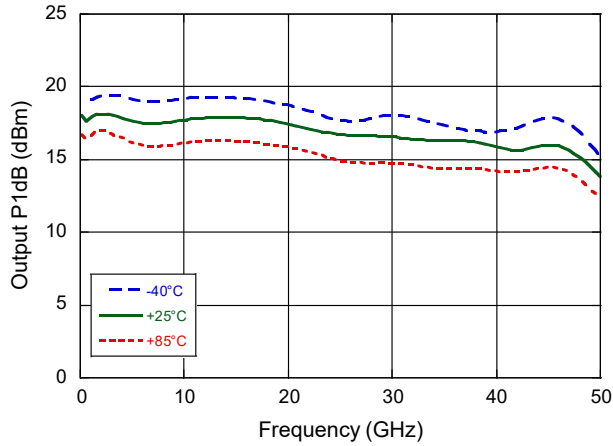

Output P3dB

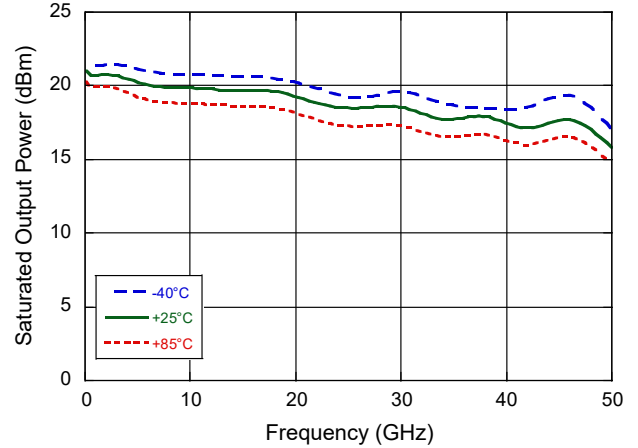

Noise Figure

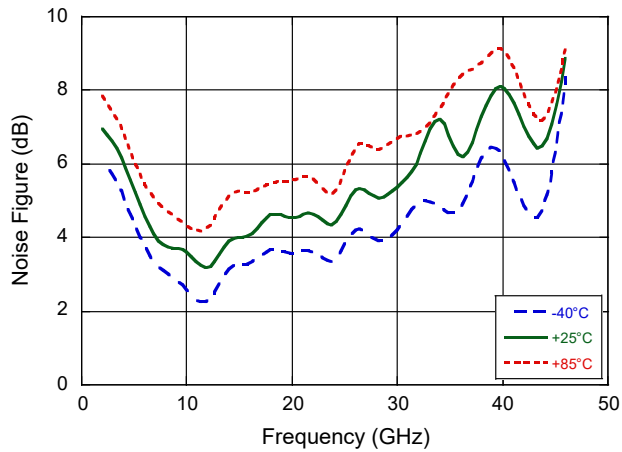

OIP3

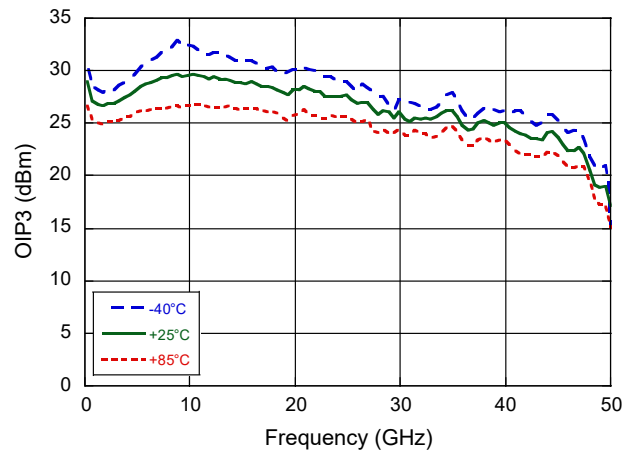

Recommended PCB Layout

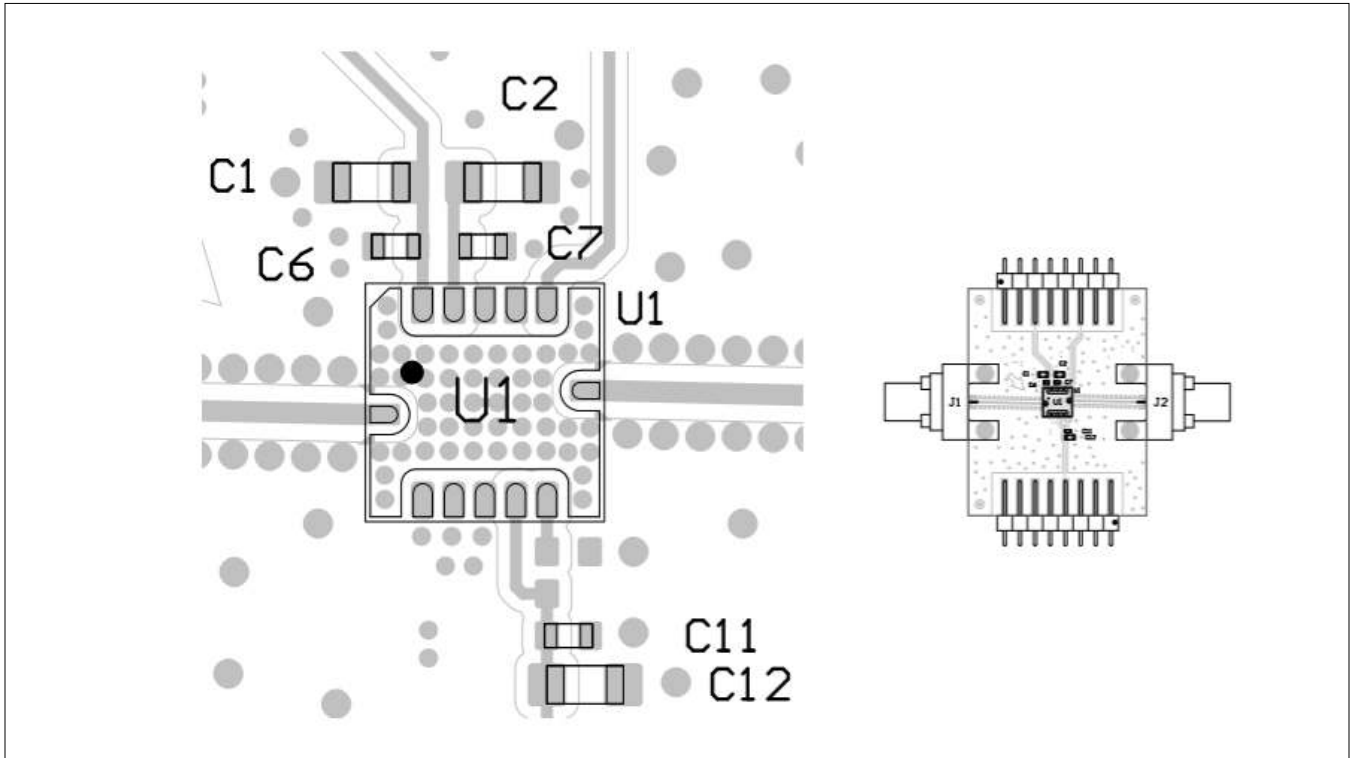

Evaluation Board Parts List

Part	Value	Case Style
C1, C2, C12	1 μ F	0603
C6 C7, C11	0.01 μ F	0402

Evaluation PCB Specifications^{12,13}

Top Layer: 1 oz Copper Cladding
Dielectric Layer: Rogers RO4350B 10 mil
Bottom Layer: 1 oz Copper Cladding
Finished overall thickness: 12.8 mil

- 12. PCB finish is ENEPIG. The vias (quantity of 50) located under the device are 8 mil in diameter and filled with thermally conductive material, capped over and planarized
- 13. Evaluation board should be mounted on a heat sink.

Wideband Distributed Amplifier

100 kHz - 50 GHz



MAAM-011238

Rev. V6

Lead-Free 5 mm 12-Lead QFN Package[†]

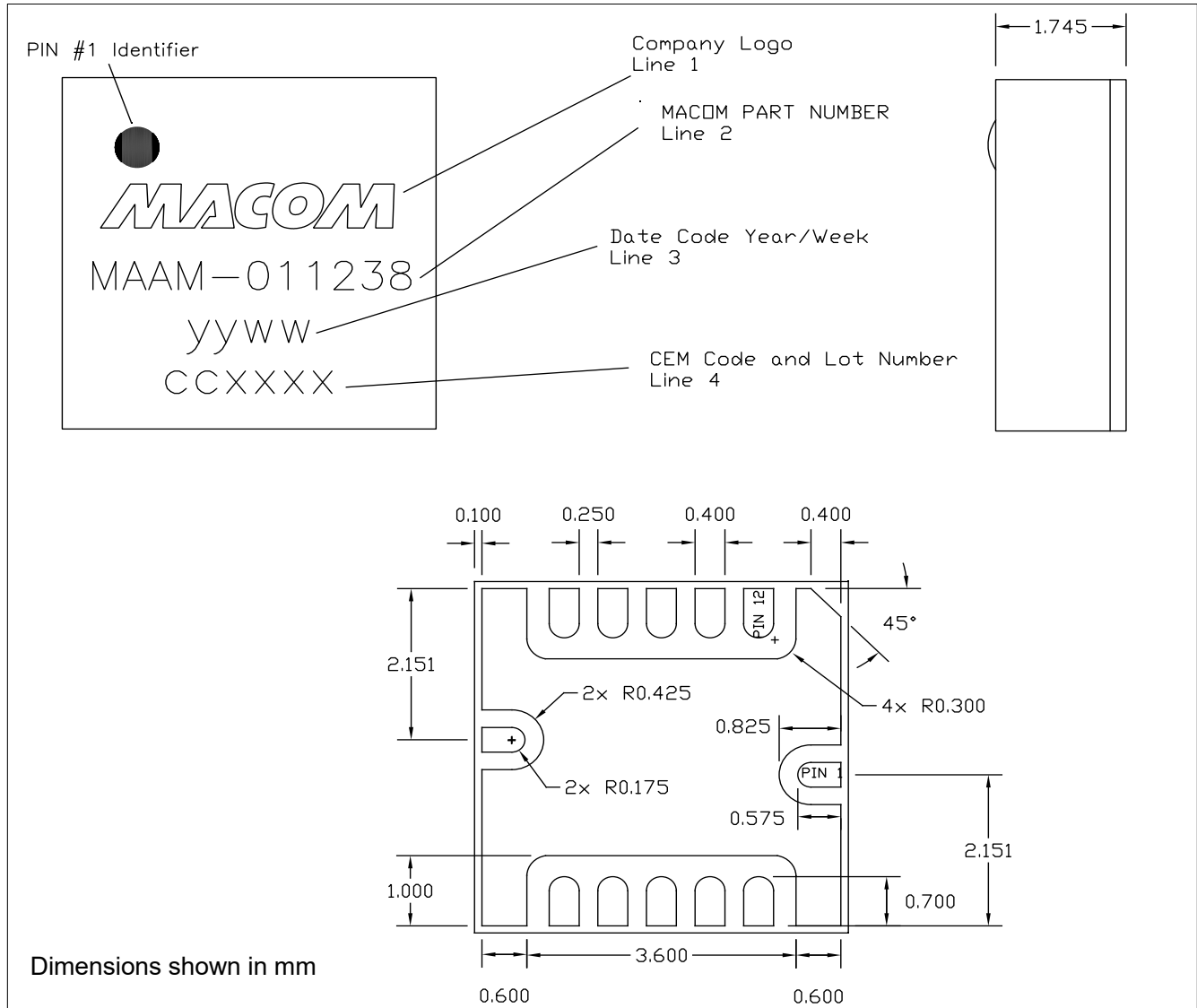

[†] Reference Application Note S2083 for lead-free solder reflow recommendations.
Meets JEDEC moisture sensitivity level 3 requirements.
Plating is ENEPIG over Copper.

Wideband Distributed Amplifier

100 kHz - 50 GHz



MAAM-011238

Rev. V6

MACOM Technology Solutions Inc. ("MACOM"). All rights reserved.

These materials are provided in connection with MACOM's products as a service to its customers and may be used for informational purposes only. Except as provided in its Terms and Conditions of Sale or any separate agreement, MACOM assumes no liability or responsibility whatsoever, including for (i) errors or omissions in these materials; (ii) failure to update these materials; or (iii) conflicts or incompatibilities arising from future changes to specifications and product descriptions, which MACOM may make at any time, without notice. These materials grant no license, express or implied, to any intellectual property rights.

THESE MATERIALS ARE PROVIDED "AS IS" WITH NO WARRANTY OR LIABILITY, EXPRESS OR IMPLIED, RELATING TO SALE AND/OR USE OF MACOM PRODUCTS INCLUDING FITNESS FOR A PARTICULAR PURPOSE, MERCHANTABILITY, INFRINGEMENT OF INTELLECTUAL PROPERTY RIGHT, ACCURACY OR COMPLETENESS, OR SPECIAL, INDIRECT, INCIDENTAL, OR CONSEQUENTIAL DAMAGES WHICH MAY RESULT FROM USE OF THESE MATERIALS.

MACOM products are not intended for use in medical, lifesaving or life sustaining applications. MACOM customers using or selling MACOM products for use in such applications do so at their own risk and agree to fully indemnify MACOM for any damages resulting from such improper use or sale.