

General Specifications

Toggles

Rockers

Pushbuttons

Illuminated PB

Programmable

Keylocks

Rotaries

Slides

Tactiles

Tilt

Touch

Indicators

Accessories

Supplement

Electrical Capacity (Resistive Load)

Logic Level: 0.4VA maximum @ 28V AC/DC maximum
(Applicable Range 0.1mA ~ 0.1A @ 20mV ~ 28V)
Note: See Supplement Index to find explanation of operating range.

Other Ratings

Contact Resistance: 80 milliohms maximum
Insulation Resistance: 100 megohms minimum @ 500V DC
Dielectric Strength: 500V AC minimum for 1 minute minimum
Mechanical Life: 30,000 operations minimum
Electrical Life: 10,000 operations minimum
Operating Torque: 0.04Nm average
Contact Timing: Nonshorting (break-before-make)
Indexing: 45° for On-On-On & 90° for On-None-On

Materials & Finishes

Shaft: Brass with nickel plating
Bushing: Zinc alloy with nickel plating
Frame/Bracket: Steel with tin plating
Movable Contacts: Beryllium copper spring with gold plating
Stationary Contacts: Copper with gold plating
Terminals: Brass with tin plating
Base: Polyamide

Environmental Data

Operating Temperature Range: -10°C through +70°C (+14°F through +158°F)
Humidity: 90 ~ 95% humidity for 96 hours @ 40°C (104°F)
Vibration: 10 ~ 55Hz with peak-to-peak amplitude of 1.5mm traversing the frequency range & returning in 1 minute; 3 right angled directions for 2 hours
Shock: 50G (490m/s²) acceleration (tested in 3 right angled directions, with 5 shocks in each direction)
Sealing: Use of optional o-ring AT535 with MRB meets IP67 of IEC60529 specifications

Installation

Mounting Torque: .686Nm (6.08 lb•in)
Cap Installation Force: 19.6 ~ 29.4N (4.41 ~ 6.61 lbf)

PCB Processing

Soldering: Wave Soldering Recommended: See Profile B in Supplement section
Manual Soldering: See Profile B in Supplement section
Cleaning: Automated cleaning. See Cleaning specifications in Supplement section.

Standards & Certifications

The MRB Series rotaries have not been tested for UL recognition or CSA certification. These switches are designed for use in a low-voltage, low-current, logic-level circuit. When used as intended in a logic-level circuit, the results do not produce hazardous energy.

Distinctive Characteristics

Double flatted bushing prevents rotation in panel and increases stability.

Totally sealed construction, achieved with combination of an interior o-ring, a seal between the frame and base, plus insert molded terminals, prevents contact contamination and allows automated soldering and cleaning.

Positive detent mechanism for distinct feel and audible feedback.

Break-before-make contact timing with sliding contact mechanism.

Metal bushing and frame/bracket provide durability.

Panel seal, achieved with use of optional exterior o-ring, conforms to IP67 of IEC60529 Standards.

High contact reliability achieved by the self-cleaning contact mechanism.

.100" x .100" (2.54mm x 2.54mm) terminal spacing conforms to standard PC board grid spacing for straight and right angle mounting.

Insert molded terminals lock out flux and other contaminants.

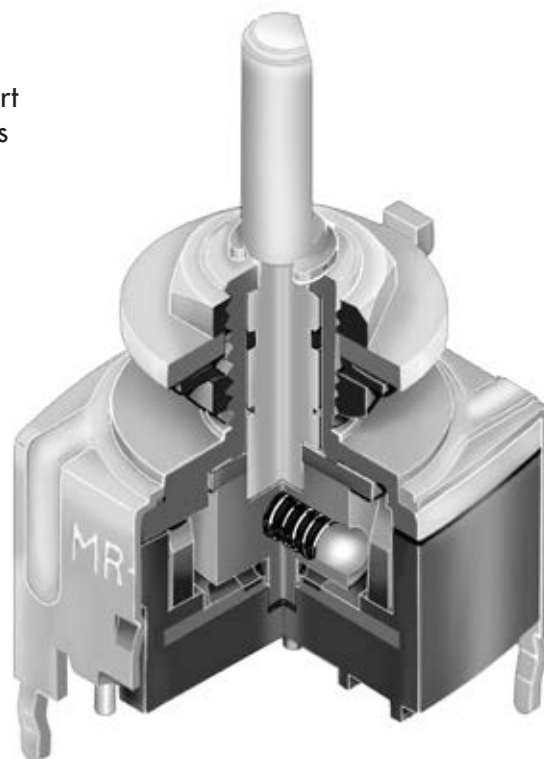

Actual Size

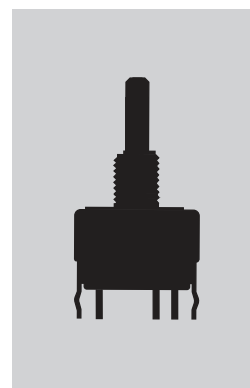

Toggles

Rockers

Pushbuttons

Illuminated PB

Programmable

Keylocks

G Rotaries

Slides

Tactiles

Tilt

Touch

Indicators

Accessories

Supplement

TYPICAL SWITCH ORDERING EXAMPLE

MRB

1

2

B — **A**

1

2

1

2

A

B

C

No Code

Black

For Color Tipped

A Black

B White

C Red

E Yellow

F Green

G Blue

H Gray

POLES

1	SPDT SP3T
2	DPDT DP3T

Terminals

B	Straight with Bracket
H	Right Angle with Bracket

Knobs

A	Plain Black
B	Small Color Tipped
C	Large Color Tipped

Circuits & Indexing

2	ON	NONE	ON	90°
4	ON	ON	ON	45°

DESCRIPTION FOR TYPICAL ORDERING EXAMPLE

MRB12B-A

Plain Black Knob

SPDT with ON-NONE-ON Circuit & 90° Indexing

Straight PC Terminals with Bracket

POLES & CIRCUITS

Pole	Model	Actuator Positions			Connected Terminals			Throw & Schematics
		Position 1	Position 2	Position 3	Position 1	Position 2	Position 3	Note: Terminal numbers are not actually on switch
SP	MRB12	ON	NONE	ON	C1-1	OPEN	C1-2	SPDT
	MRB14	ON	ON	ON	C1-1	C1-2	C1-3	SP3T
DP	MRB22	ON	NONE	ON	C1-1 C2-4	OPEN	C1-2 C2-5	DPDT
	MRB24	ON	ON	ON	C1-1 C2-4	C1-2 C2-5	C1-3 C2-6	DP3T

TERMINALS

B Straight PC Terminals with Bracket

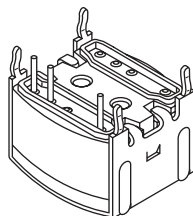

SPDT

H Right Angle PC Terminals with Bracket

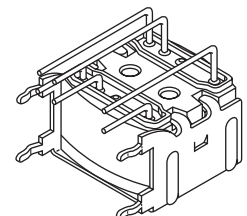

DPDT

TYPICAL SWITCH DIMENSIONS

90° Indexing • SPDT & DPDT • Straight PC

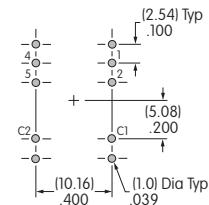
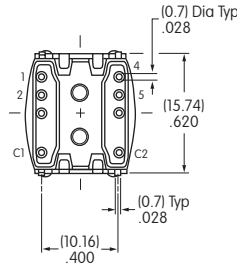
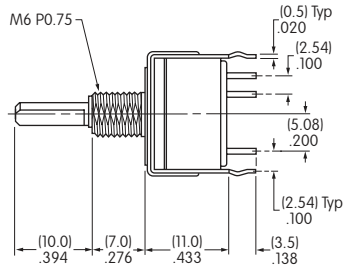
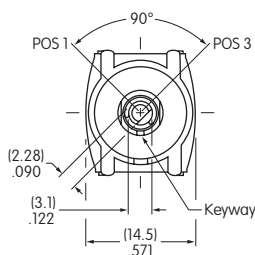

Actuator shown in Position 1

Single pole model does not have terminals 4, 5 & C2

MRB12B

90° Indexing • SPDT • Right Angle PC

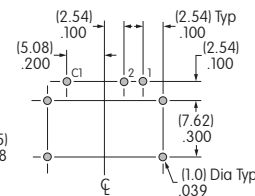
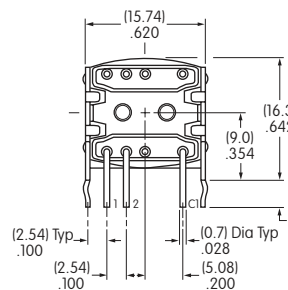
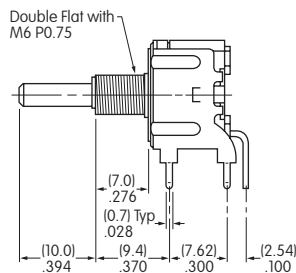
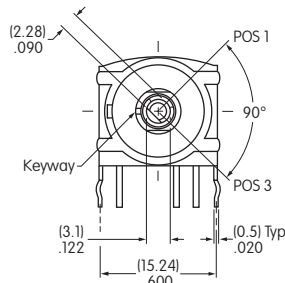

Actuator shown in Position 1

MRB12H

90° Indexing • DPDT • Right Angle PC

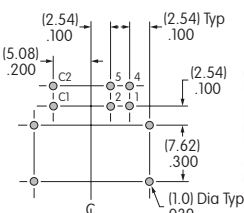
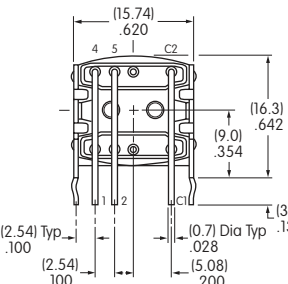
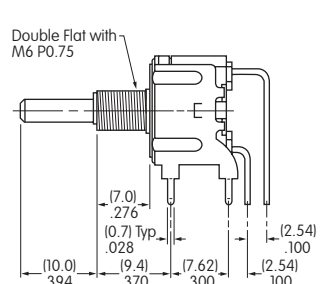
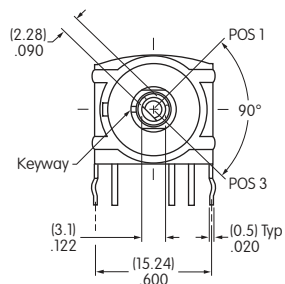

Actuator shown in Position 1

MRB22H

45° Indexing • SP3T & DP3T • Straight PC

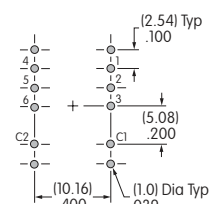
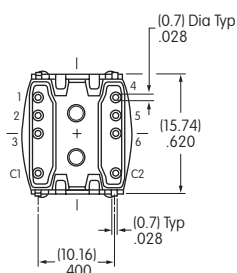
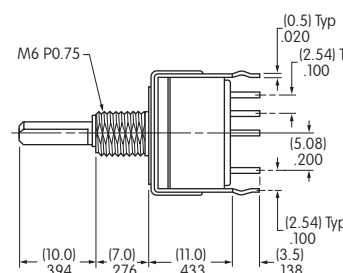
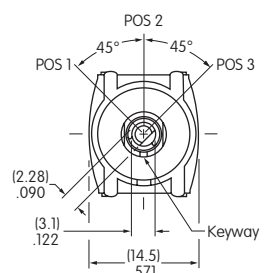

Actuator shown in Position 1

Single pole model does not have terminals 4, 5, 6 & C2

MRB14B

TYPICAL SWITCH DIMENSIONS

45° Indexing • SP3T • Right Angle PC

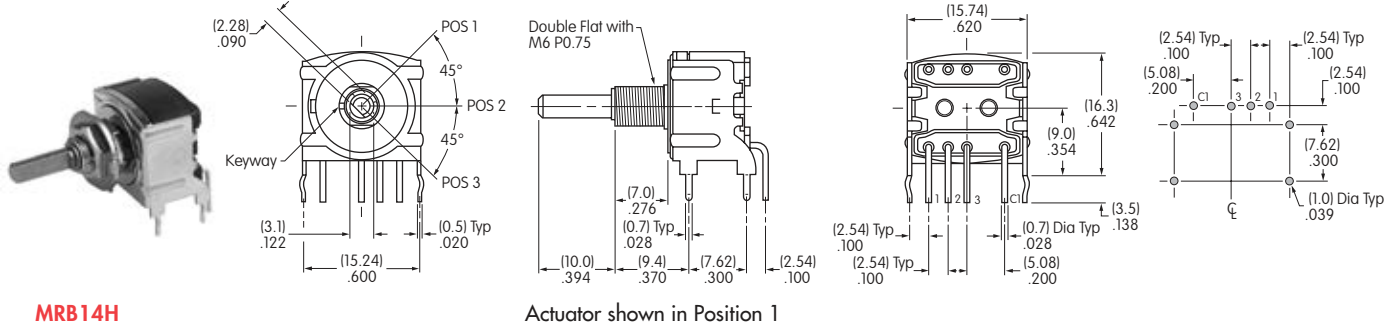

45° Indexing • DP3T • Right Angle PC

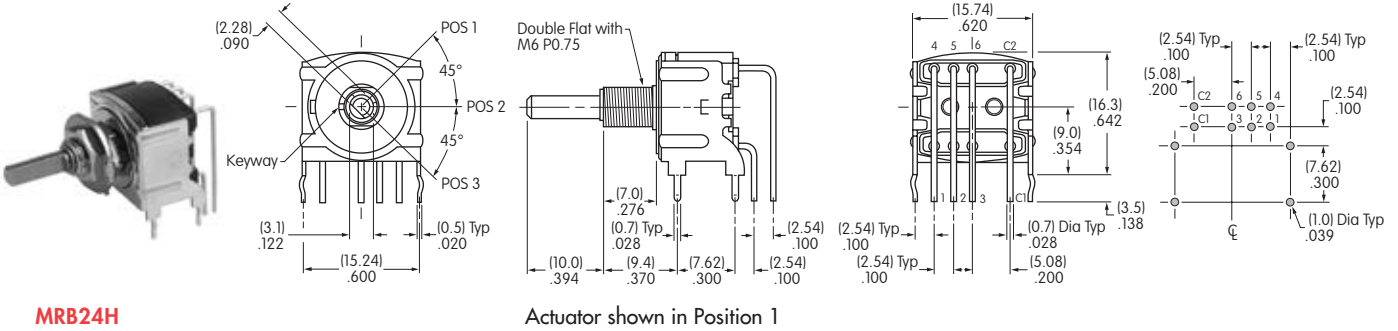

KNOBS

A AT433 Plain Black

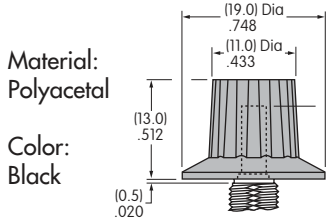

B AT4103 Small Color Tipped

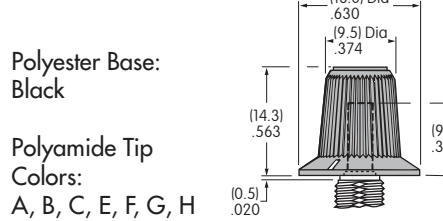

C AT4104 Large Color Tipped

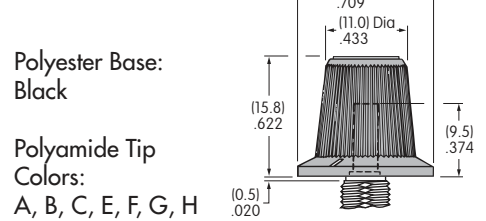

Color Codes: **A** Black **B** White **C** Red **E** Yellow **F** Green **G** Blue **H** Gray

Shaft Detail

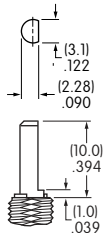

Mounting Precaution for Cap Clearance on Right Angle Models

When mounting a right angle switch, a cap clearance of .035" (0.9mm) is recommended.

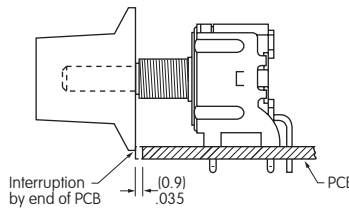

Standard Hardware Supplied

AT513M Hex Nut
AT545 Locking Ring
AT509 Lockwasher
Optional Hardware
AT535 O-ring for Panel Seal
See Supplement for details

PANEL CUTOUTS & MAXIMUM EFFECTIVE PANEL THICKNESS

With Standard Hardware
.087" (2.2mm)

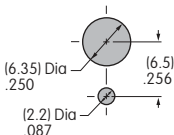

Without Locking Ring
.118" (3.0mm)

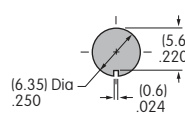

Sealed Panel with 1 Hex Nut & 1 Rubber O-ring
.165" (4.2mm)

