



IP65 IP67



## Features

- Wide input range 180 ~ 528VAC
- Constant Current mode output
- Metal housing with Class I design
- Built-in active PFC function
- IP67 / IP65 design for indoor or outdoor installations
- Function options: output adjustable via potentiometer; 3 in 1 dimming (dim-to-off) ; Timer dimming
- Typical lifetime>50000 hours
- 5 years warranty

## Applications

- LED street lighting
- LED high-bay lighting
- Parking space lighting
- LED fishing lamp

## GTIN CODE

MW Search: <https://www.meanwell.com/serviceGTIN.aspx>

## Description

HVGC-65 series is a 65W LED AC/DC LED power supply featuring the constant current mode and high voltage output. HVGC-65 operates from 180~528VAC and offers models with different rated current ranging between 350mA and 1050mA. Thanks to the high efficiency up to 90.5%, with the fanless design, the entire series is able to operate for -40°C ~ +80°C case temperature under free air convection. The design of metal housing and IP67/IP65 ingress protection level allows this series to fit both indoor and outdoor applications. HVGC-65 is equipped with various function options, such as dimming methodologies, so as to provide the optimal design flexibility for LED lighting system.

## Model Encoding

HVGC - 65 - 1050 A

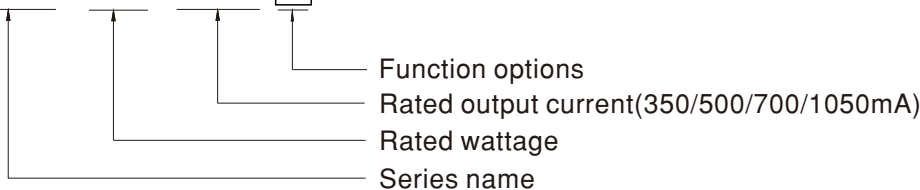

| Type | IP Level | Function  | Note       |
|------|----------|---|------------|
| A    | IP65     | Io adjustable through built-in potentiometer.   | In Stock   |
| B    | IP67     | 3 in 1 dimming function (0~10Vdc, 10V PWM signal and resistance)  | In Stock   |
| AB   | IP65     | Io adjustable through built-in potentiometer & 3 in 1 dimming function (0~10Vdc, 10V PWM signal and resistance) | In Stock   |
| D    | IP67     | Timer dimming function, contact MEAN WELL for details(safety pending).  | By request |



**SPECIFICATION**

| MODEL                             | HVGC-65-350 <input type="checkbox"/>   | HVGC-65-500 <input type="checkbox"/>  | HVGC-65-700 <input type="checkbox"/> | HVGC-65-1050 <input type="checkbox"/> |              |
|-----------------------------------|--|---|--------------------------------------|---------------------------------------|--------------|
| OUTPUT                            | RATED CURRENT  | 350mA   | 500mA                                | 700mA                                 | 1050mA       |
|                                   | RATED POWER  | 65.1W   | 65W                                  | 65.1W                                 | 65.1W        |
|                                   | CONSTANT CURRENT REGION <small>Note.2</small>  | 18 ~ 186V   | 13 ~ 130V                            | 9 ~ 93V                               | 6 ~ 62V      |
|                                   | CURRENT ADJ. RANGE   | Adjustable for A/AB-Type only (via the built-in potentiometer)  |                                      |                                       |              |
|                                   |  | 210 ~ 350mA   | 300 ~ 500mA                          | 420 ~ 700mA                           | 630 ~ 1050mA |
|                                   | CURRENT TOLERANCE  | ±5.0%   |                                      |                                       |              |
|                                   | CURRENT RIPPLE <small>Note.5</small>   | 5.0% max. @rated current  |                                      |                                       |              |
| SET UP TIME <small>Note.4</small> | 500ms / 230Vac 400ms / 347VAC,480VAC   |   |                                      |                                       |              |
| INPUT                             | VOLTAGE RANGE <small>Note.3</small>  | 180 ~ 528VAC 254VDC ~ 747VDC<br>(Please refer to "STATIC CHARACTERISTIC" section)   |                                      |                                       |              |
|                                   | FREQUENCY RANGE  | 47 ~ 63Hz   |                                      |                                       |              |
|                                   | POWER FACTOR (Typ.)  | PF ≥ 0.98/230VAC, PF ≥ 0.97/277VAC, PF ≥ 0.95/347VAC, PF ≥ 0.93/480VAC @full load<br>(Please refer to "POWER FACTOR (PF) CHARACTERISTIC" section) |                                      |                                       |              |
|                                   | TOTAL HARMONIC DISTORTION  | THD < 20% (@ load ≥ 60%/230VAC, 277VAC, 347VAC; @ load ≥ 75%/480VAC)<br>(Please refer to "TOTAL HARMONIC DISTORTION (THD)" section)               |                                      |                                       |              |
|                                   | EFFICIENCY (Typ.)  | 90%   | 90.5%                                | 90.5%                                 | 90%          |
|                                   | AC CURRENT (Typ.)  | 0.22A / 347VAC 0.18A / 480VAC   |                                      |                                       |              |
|                                   | INRUSH CURRENT (Typ.)  | COLD START 25A( <i>t</i> <sub>width</sub> =420μs measured at 50% I <sub>peak</sub> ) at 480VAC; Per NEMA 410                                      |                                      |                                       |              |
|                                   | MAX. No. of PSUs on 16A CIRCUIT BREAKER  | 12 units (circuit breaker of type B) / 20 units (circuit breaker of type C) at 480VAC   |                                      |                                       |              |
|                                   | LEAKAGE CURRENT  | <0.75mA / 480VAC  |                                      |                                       |              |
| PROTECTION                        | SHORT CIRCUIT  | Constant current limiting, recovers automatically after fault condition is removed  |                                      |                                       |              |
|                                   | OVER VOLTAGE   | 195 ~ 210V  | 137 ~ 150V                           | 98 ~ 107V                             | 65 ~ 72V     |
|                                   | OVER TEMPERATURE   | Shut down o/p voltage with auto-recovery or re-power on to recovery   |                                      |                                       |              |
| ENVIRONMENT                       | WORKING TEMP.  | T <sub>case</sub> =-40 ~ +80°C (Please refer to "OUTPUT LOAD vs TEMPERATURE" section)   |                                      |                                       |              |
|                                   | MAX. CASE TEMP.  | T <sub>case</sub> =+80°C  |                                      |                                       |              |
|                                   | WORKING HUMIDITY   | 20 ~ 95% RH non-condensing  |                                      |                                       |              |
|                                   | STORAGE TEMP., HUMIDITY  | -40 ~ +80°C, 10 ~ 95% RH  |                                      |                                       |              |
|                                   | TEMP. COEFFICIENT  | ±0.03%/°C (0 ~ 60°C)  |                                      |                                       |              |
|                                   | VIBRATION  | 10 ~ 500Hz, 5G 12min./1cycle, period for 72min. each along X, Y, Z axes   |                                      |                                       |              |
| SAFETY & EMC                      | SAFETY STANDARDS   | UL8750, CSA C22.2 No. 250.13-12, ENEC BS EN/EN61347-1, BS EN/EN61347-2-13, BS EN/EN62384, independent, EAC TP TC 004, IP65 or IP67 approved       |                                      |                                       |              |
|                                   | WITHSTAND VOLTAGE  | I/P-O/P:3.75KVAC I/P-FG:2KVAC O/P-FG:1.5KVAC  |                                      |                                       |              |
|                                   | ISOLATION RESISTANCE   | I/P-O/P, I/P-FG, O/P-FG:100M Ohms / 500VDC / 25°C / 70% RH  |                                      |                                       |              |
|                                   | EMC EMISSION <small>Note.6</small>   | Compliance to BS EN/EN55015, BS EN/EN61000-3-2 Class C (@ load ≥ 60%); BS EN/EN61000-3-3, FCC Part 15 Subpart B, EAC TP TC 020                    |                                      |                                       |              |
|                                   | EMC IMMUNITY   | Compliance to BS EN/EN61000-4-2,3,4,5,6,8,11, BS EN/EN61547, light industry level (surge immunity Line-Earth 4KV, Line-Line 2KV), EAC TP TC 020   |                                      |                                       |              |
| OTHERS                            | MTBF   | 2164.4K hrs min. Telcordia SR-332 (Bellcore); 202.8K hrs min. MIL-HDBK-217F (25°C)  |                                      |                                       |              |
|                                   | DIMENSION  | 189*61.5*36.8mm (L*W*H)   |                                      |                                       |              |
|                                   | PACKING  | 0.77Kg; 18pcs/14.9Kg/0.89CUFT   |                                      |                                       |              |
| NOTE                              | <ol style="list-style-type: none"> <li>All parameters NOT specially mentioned are measured at 347VAC input, rated current and 25°C of ambient temperature.</li> <li>Please refer to "DRIVING METHODS OF LED MODULE".</li> <li>Please refer to "STATIC CHARACTERISTIC" sections for details.</li> <li>Length of set up time is measured at first cold start. Turning ON/OFF the power supply may lead to increase of the set up time.</li> <li>It is measured 50%~100% of maximum voltage under rated power delivery.</li> <li>The driver is considered as a component that will be operated in combination with final equipment. Since EMC performance will be affected by the complete installation, the final equipment manufacturers must re-qualify EMC Directive on the complete installation again.</li> <li>To fulfill requirements of the latest ErP regulation for lighting fixtures, this LED driver can only be used behind a switch without permanently connected to the mains.</li> <li>This series meets the typical life expectancy of &gt;50,000 hours of operation when T<sub>case</sub>, particularly (⊙) point (or TMP, per DLC), is about 75°C or less.</li> <li>Please refer to the warranty statement on MEAN WELL's website at <a href="http://www.meanwell.com">http://www.meanwell.com</a>.</li> <li>The ambient temperature derating of 3.5°C/1000m with fanless models and of 5°C/1000m with fan models for operating altitude higher than 2000m(6500ft).</li> <li>For any application note and IP water proof function installation caution, please refer our user manual before using.<br/><a href="https://www.meanwell.com/Upload/PDF/LED_EN.pdf">https://www.meanwell.com/Upload/PDF/LED_EN.pdf</a></li> </ol> <p>※ Product Liability Disclaimer : For detailed information, please refer to <a href="https://www.meanwell.com/serviceDisclaimer.aspx">https://www.meanwell.com/serviceDisclaimer.aspx</a></p> |   |                                      |                                       |              |

### Block Diagram

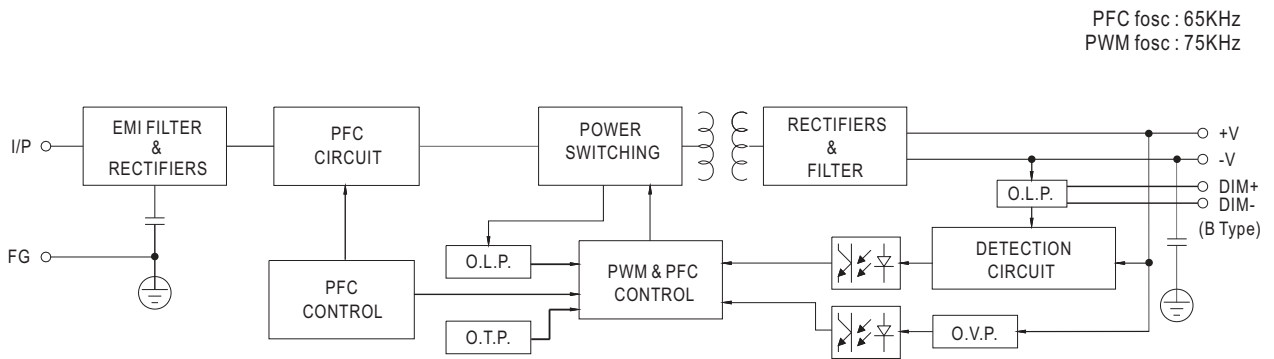

### DRIVING METHODS OF LED MODULE

※ This series works in constant current mode to directly drive the LEDs.

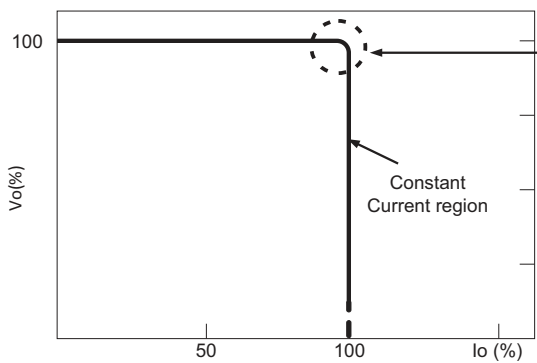

Typical output current normalized by rated current (%)

In the constant current region, the highest voltage at the output of the driver depends on the configuration of the end systems.

Should there be any compatibility issues, please contact MEAN WELL.

## ■ DIMMING OPERATION

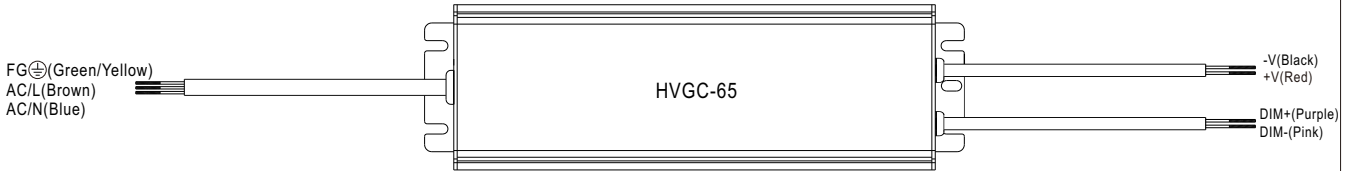

### ※ 3 in 1 dimming function (for B/AB-Type)

- Output constant current level can be adjusted by applying one of the three methodologies between DIM+ and DIM-:  
0 ~ 10VDC, or 10V PWM signal or resistance.
- Direct connecting to LEDs is suggested. It is not suitable to be used with additional drivers.
- Dimming source current from power supply: 100 $\mu$ A (typ.)

◎ Applying additive 0 ~ 10VDC

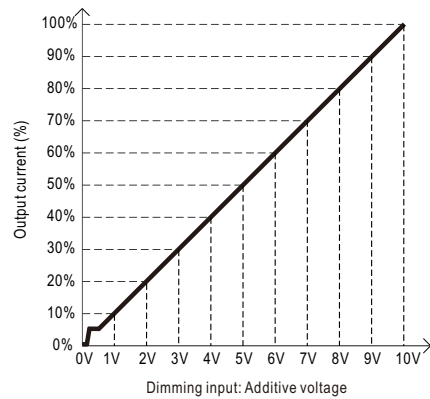
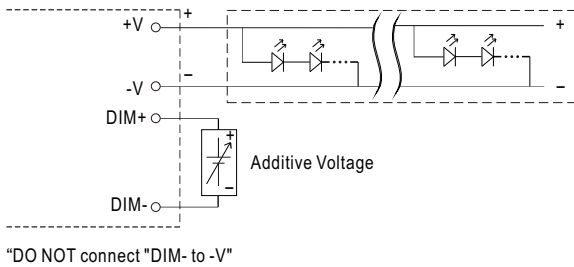

◎ Applying additive 10V PWM signal (frequency range 100Hz ~ 3KHz):

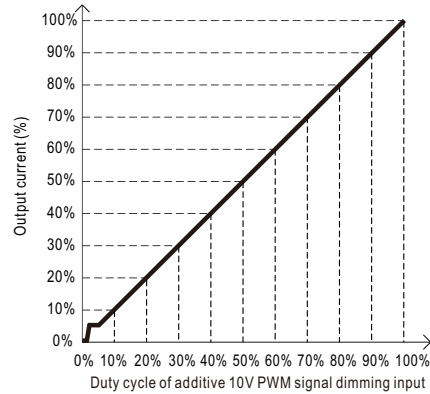
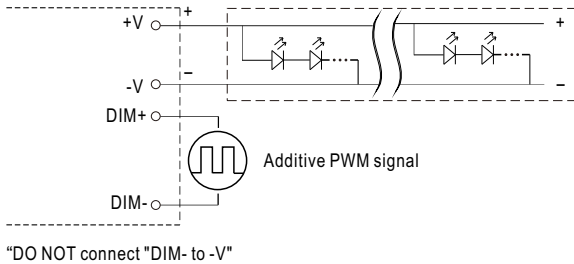

◎ Applying additive resistance:

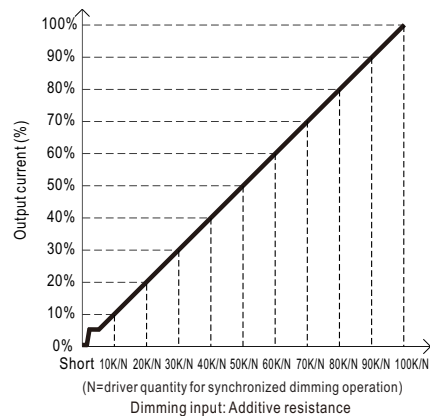
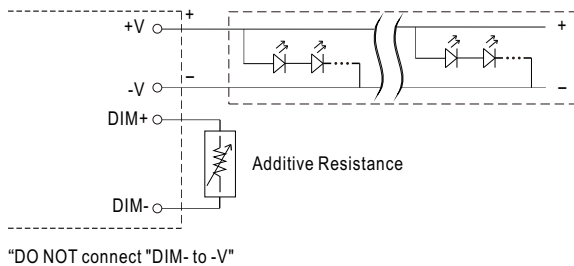

Note : 1. Min. dimming level is about 6% and the output current is not defined when 0% < I<sub>out</sub> < 6%.

2. The output current could drop down to 0% when dimming input is about 0k $\Omega$  or 0Vdc, or 10V PWM signal with 0% duty cycle.

### OUTPUT LOAD vs TEMPERATURE(Nota.9)

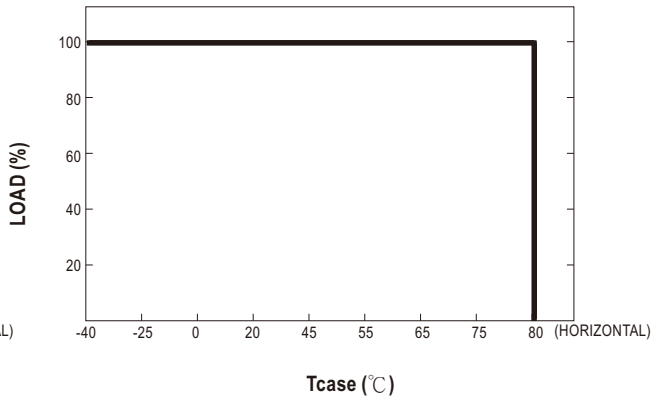
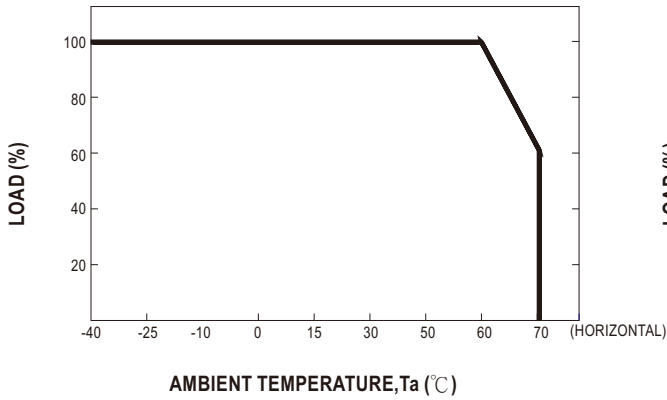

### STATIC CHARACTERISTIC

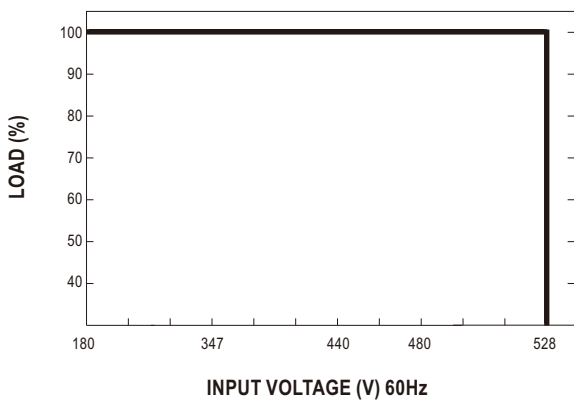

※ De-rating is needed under low input voltage.

### POWER FACTOR (PF) CHARACTERISTIC

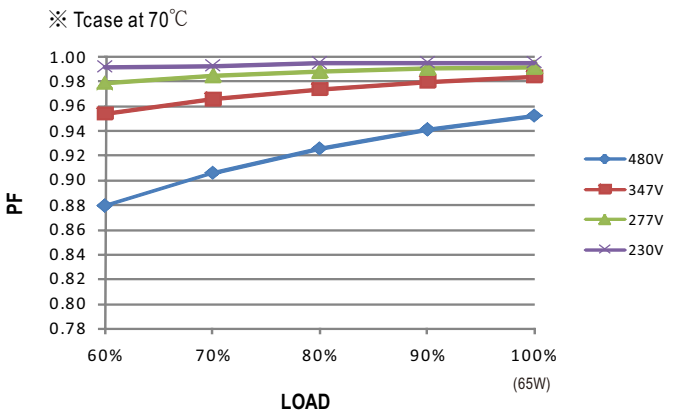

### TOTAL HARMONIC DISTORTION (THD)

※ 700mA Model, Tcase at 70°C

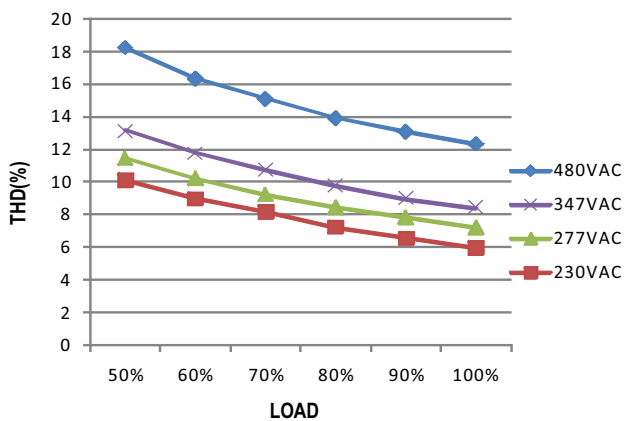

### EFFICIENCY vs LOAD

HVGC-65 series possess superior working efficiency that up to 90.5% can be reached in field applications.

※ 700mA Model, Tcase at 70°C

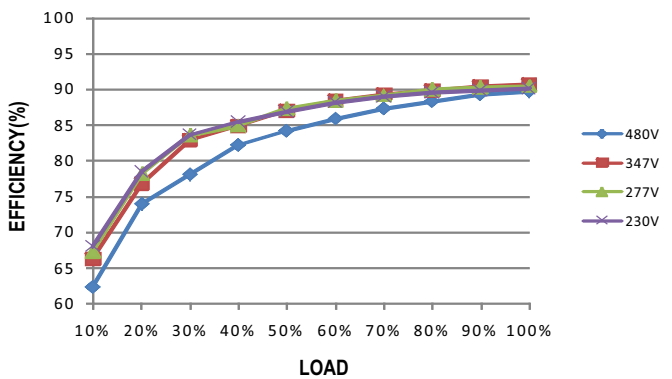

■ LIFE TIME

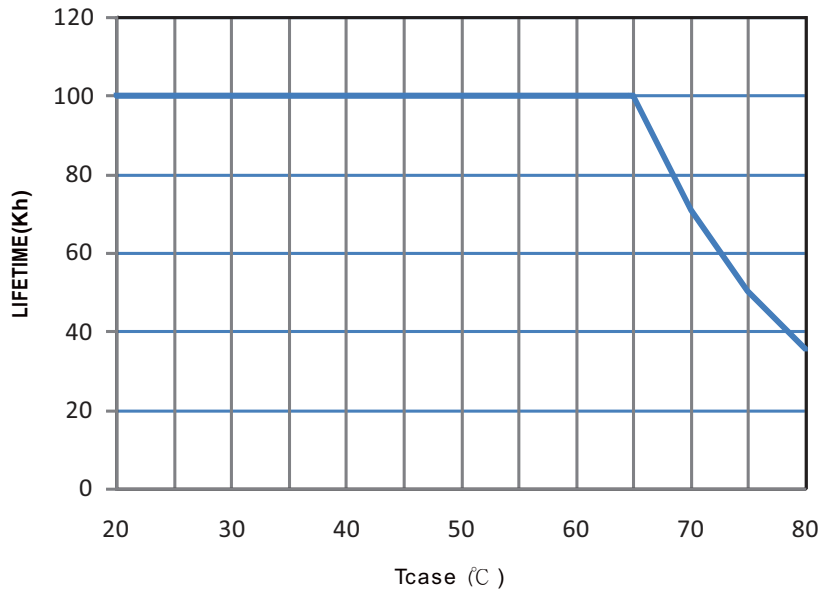

**MECHANICAL SPECIFICATION**

Case No. 957 Unit:mm

※ **A-Type**

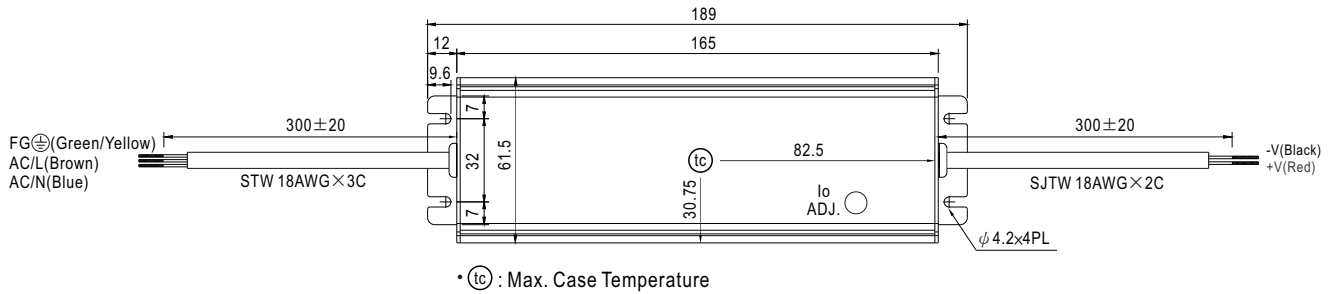

※ **B-Type**

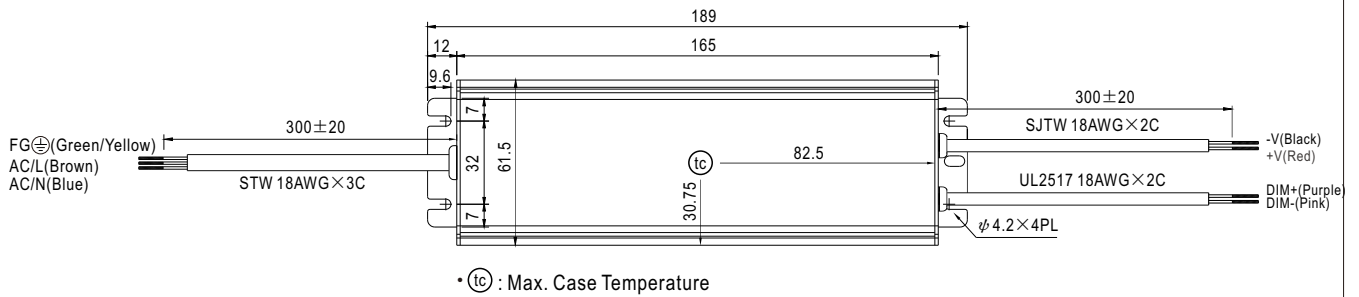

※ AB-Type

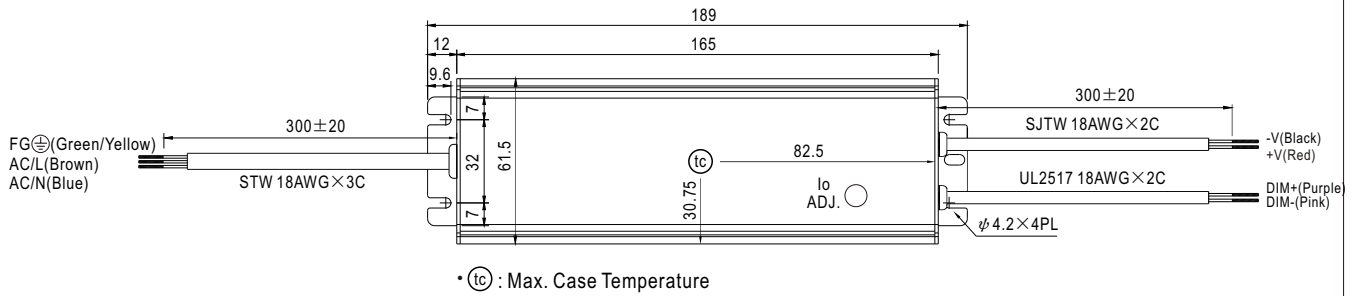

※ D-Type

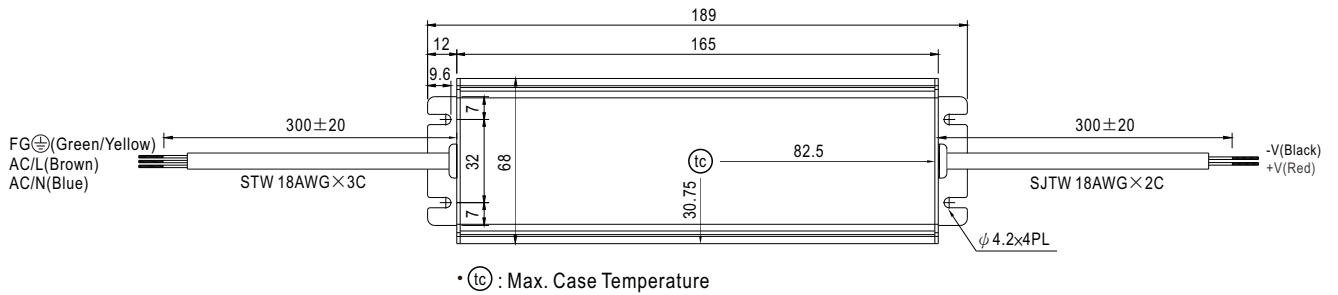



## ■ WATERPROOF CONNECTION

### ※ Waterproof connector

Waterproof connector can be assembled on the output cable of HVGC-65 to operate in dry/wet/damp or outdoor environment.

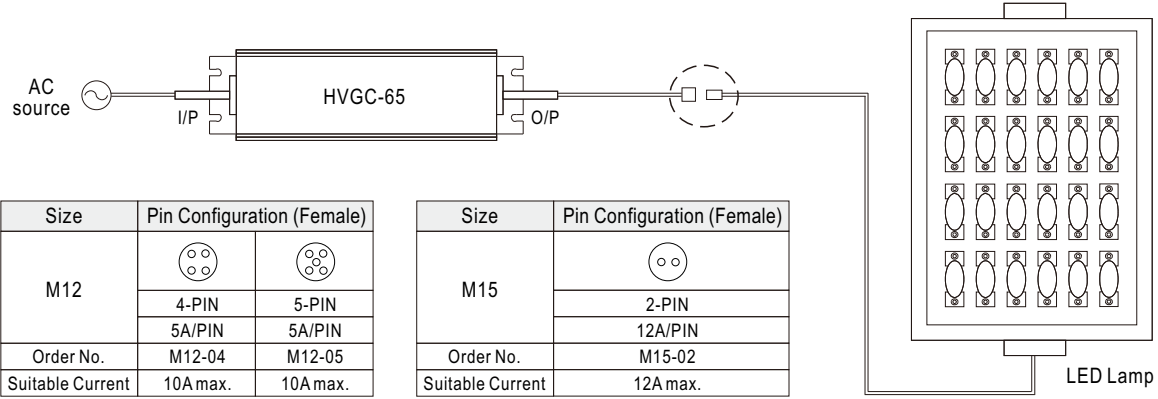

### ※ Cable Joiner

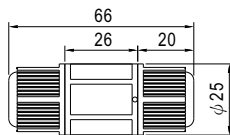

CJ04-1 suitable for 14AWG~16AWG  
CJ04-2 suitable for 18AWG~22AWG



Up to four wires can be connected through this cable joiner by soldering or clamping by tools.

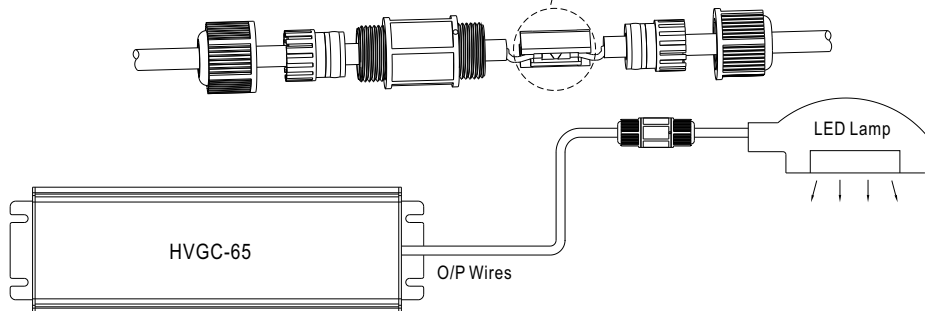

© CJ04 cable joiner can be purchased independently for user's own assembly.  
MEAN WELL order No. : CJ04-1, CJ04-2.

## ■ INSTALLATION MANUAL

Please refer to : <http://www.meanwell.com/manual.html>