

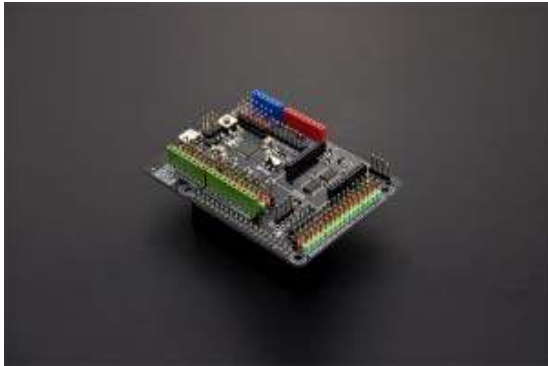

Arduino Shield for Raspberry Pi 2B and 3B SKU:DFR0327



Contents

- 1 Introduction
- 2 Specification
- 3 Features
- 4 Raspberry Pi B+ Meet Arduino Shield Pinout
 - 4.1 Feature Introduction Diagram
- 5 Get Started with Raspberry Pi B+ Meet Arduino Shield
 - 5.1 Tools Required
 - 5.2 Software Required
 - 5.3 Hardware Connection
 - 5.4 Step by Step tutorial
- 6 Program the Arduino shield using Raspberry Pi B+
 - 6.1 Software Required
 - 6.2 Steps
 - 7 FAQ

Introduction

What happens when a Pi meets an Arduino?

A simple example would be, when building a mobile robot, we use the Raspberry Pi to extend its vision and get a nice tiny monitor. Meanwhile, Arduino handle nicely with the motor driving part and delivers fast responses like obstacle avoidance. Because, without the OS, the response time of rapid changes on the Arduino is much shorter. Also the high performance Pi can deals much easily with wireless communications, imaging and running complex algorithm.

Therefore, with the Arduino and Pi together, you get a powerful "brain" and "cerebellum" for your project, at one time.

Specification

- Onboard Microcontroller: ATmega32u4
- Arduino Leonardo Chip
- Arduino Compatible pin mapping
- Compatible with All arduino standard shield and sensors
- System Voltage: 5v
- Arduino Digital I/O: 20
- Arduino Analog I/O: 6
- Raspberry Pi B+ GPIO : 16
- Raspberry Pi B+ I2C: 1
- Raspberry Pi B+ ID_I2C: 1
- Raspberry Pi B+ SPI: 1
- Raspberry Pi B+ TTL UART: 1
- Dimension: 88mm x 56mm x 26mm

Features

- Integrate with the Xbee socket
Available to be connected to Arduino or Raspberry Pi B+ directly either
Compatible with BLE Link(BT4.0)/Bluetooth Bee(BT2.1) and xbee modules
- Embedded DS1307 RTC module,which keeps time of the Pi even when the power is off, or the battery removed
- Bidirectional logic converter for Raspberry Pi B+ GPIO to convert signal between 3.3v and 5v
- 3 pin headers sensor port for Arduino pins and B+ GPIO, directly compatible with hundreds of Arduino sensors and modules,like:
Relay Module V3.1 for IOT AC control
Analog pH Meter Kit for monitoring Water quality of your pool
SHT1x Humidity and Temperature Sensor
Motion Sensor for security and human detection
And so on...
- Arduino shield compatible layout makes it possible to extend Arduino shield features for your Pi also,
A nice and low cost LCD12864 display
2A Motor Shield for robot building
Dual Bipolar Stepper Motor Shield
GSM/GPRS and GPS Shield

Raspberry Pi B+ Meet Arduino Shield Pinout

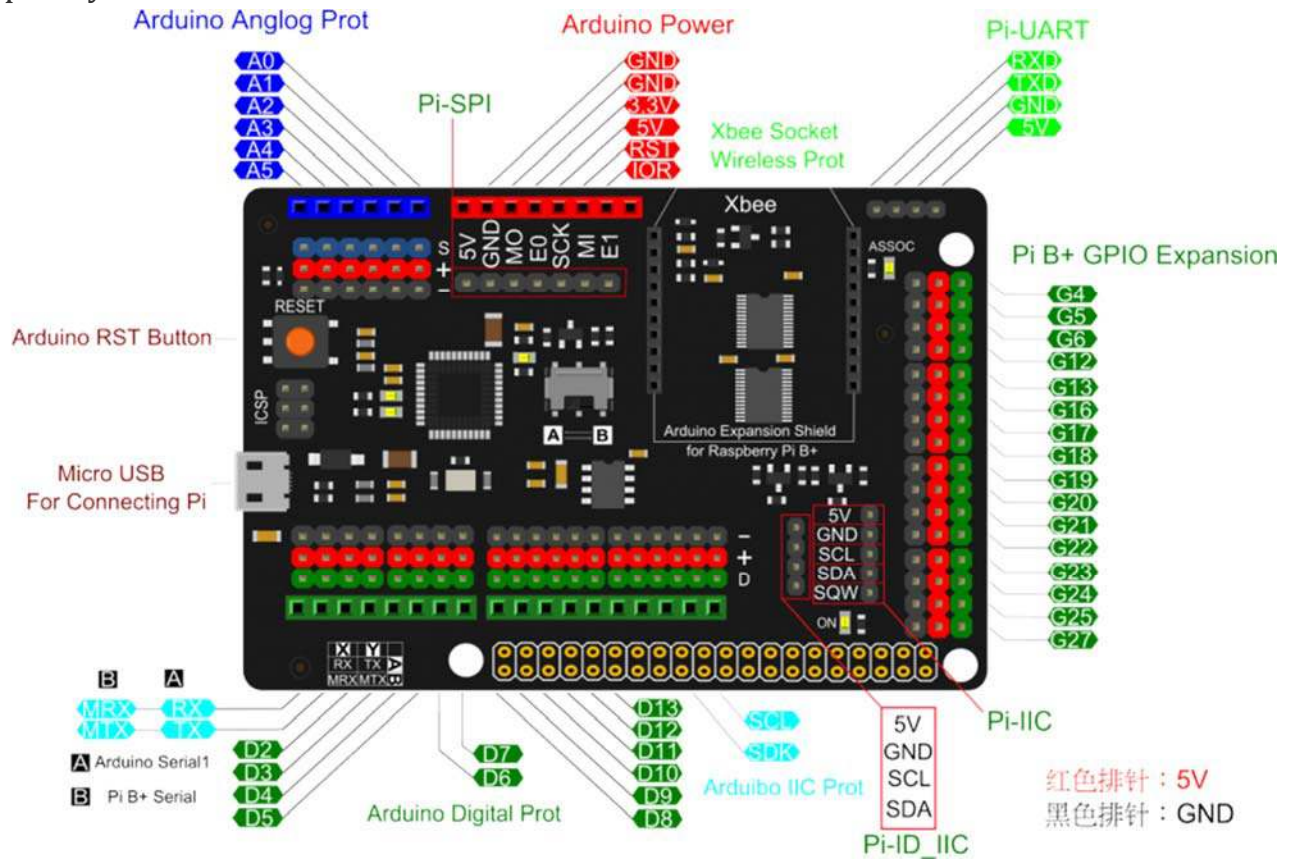

Fig1: Pi Meet Arduino Pinout

NOTE: The ID-I2C is an EEPROM interface, which is dedicated to connect to external EEPROM, it will test automatically EEPROM devices attached to it when it starts, is used for configuring GPIO and Linux drivers. In theory, it can be used as an ordinary IIC.

Feature Introduction Diagram

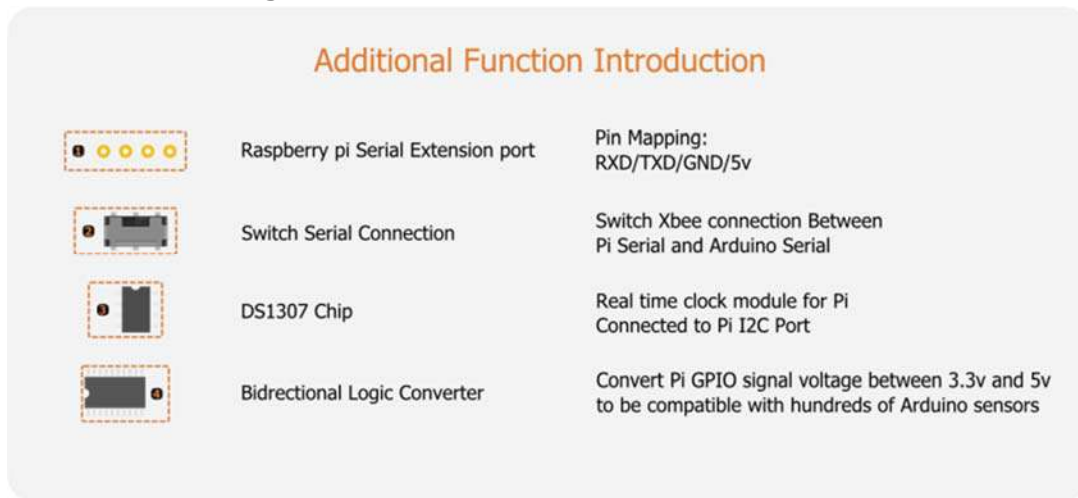

Fig2: Feature Introduction

Get Started with Raspberry Pi B+ Meet Arduino Shield

First of all, let's control a sensor by Raspberry Pi directly with Meet Arduino Shield. Note: For this tutorial, we assume that you've known the basic knowledge about the Raspberry Pi B+. And more details will be focused on how to extend and use more hardware modules and sensors for your Raspberry pi B+ projects. In this part, we will control the Relay module with Python via Pi's GPIO.

Tools Required

1. Raspberry Pi B+ with Ethernet or WIFI connected
2. Raspberry Pi B+ Meet Arduino shield
3. [Relay module](#) (or and LED module)

Software Required

1. Python 2 Installed.
2. Setup SSH on Raspberry Pi.

If you didn't install python. Please enter the following commands below into LX Terminal via SSH.

```
root@raspberrypi:/home/pi# sudo apt-get update
root@raspberrypi:/home/pi# sudo apt-get install python-rpi.gpio
```

Hardware Connection

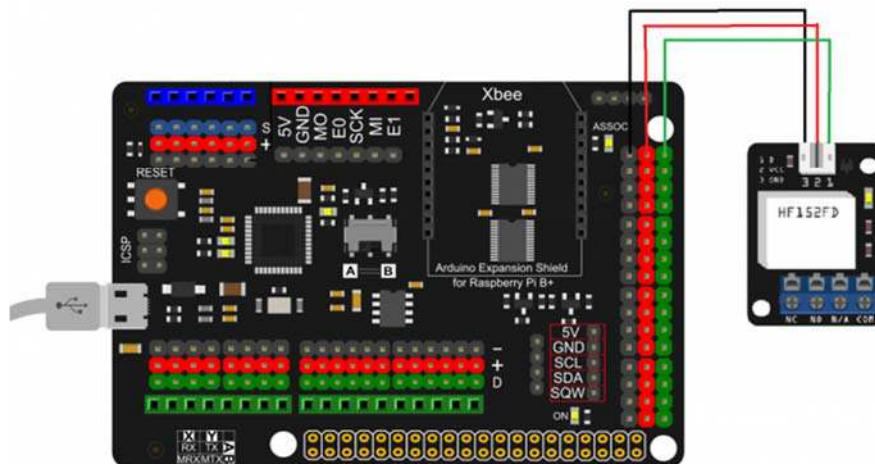
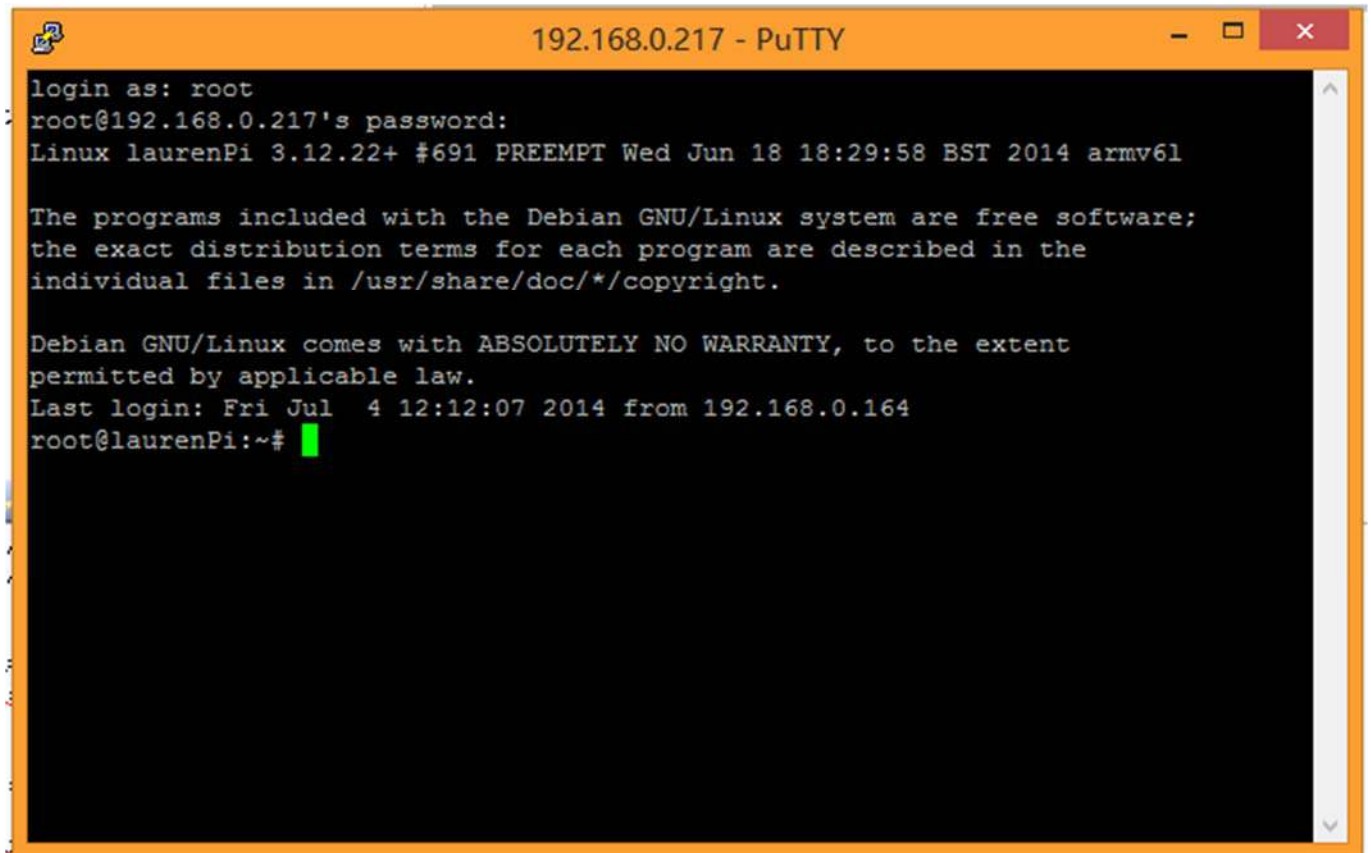

Fig3: Relay CD

Step by Step tutorial

- 1.Plug the Pi Meet Arduino shield to the Raspberry Pi B+, Which connected with the power and Ethernet.
- 2.Connect the Relay module(or LED module) to your Pi as the hardware connection shown.
- 3.Login in your Pi by [Putty](#).



```
192.168.0.217 - PuTTY
login as: root
root@192.168.0.217's password:
Linux laurenPi 3.12.22+ #691 PREEMPT Wed Jun 18 18:29:58 BST 2014 armv61

The programs included with the Debian GNU/Linux system are free software;
the exact distribution terms for each program are described in the
individual files in /usr/share/doc/*/copyright.

Debian GNU/Linux comes with ABSOLUTELY NO WARRANTY, to the extent
permitted by applicable law.
Last login: Fri Jul  4 12:12:07 2014 from 192.168.0.164
root@laurenPi:~#
```

Fig4: Login SSH

- 4.Create a Python example code using nano.

```
root@raspberrypi:/home/pi# nano blink.py
```

```
import RPi.GPIO as GPIO
```

```
import time

GPIO.setmode(GPIO.BCM)
GPIO.setup(4, GPIO.OUT)

while True:
    GPIO.output(4, GPIO.HIGH)
    time.sleep(1)
    GPIO.output(4, GPIO.LOW)
    time.sleep(1)
```

5. Run the python sample by the command below. And Check the effect. PS: The module is connected to the GPIO 4 matching the software configuration.

```
root@raspberrypi:/home/pi# python blink.py
```

6. <Ctrl>+<C> to stop running the python demo. =. = The switching of the relay module create the noise...

Program the Arduino shield using Raspberry Pi B+

In this part, we will share how to program your Arduino using Pi. The steps is quite simple what you need is just installing the Arduino on your Pi and run the remote desktop to test it.

Software Required

1. [TightVNC Viewer](#) on your PC
2. TightVNC on your Pi
3. Arduino IDE on your Pi

To install the TightVNC on your Pi, please check the commands below.

```
root@raspberrypi:/home/pi# sudo apt-get update
root@raspberrypi:/home/pi# sudo apt-get install tightvncserver
```

And to install the Arduino IDE on your Pi.

```
root@raspberrypi:/home/pi# sudo apt-get install arduino
```

Steps

1. Connect the micro usb from Meet Arduino shield to the USB host on the Pi.
2. Launch your VNC server on the Raspberry Pi B+.

```
root@raspberrypi:/home/pi# sudo vncserver
```

1. Log in the remote desktop to Pi using TightVNC Viewer.
2. Launch your Arduino IDE. Open the blink sample sketch. Choose the leonardo as the board connected and open the right port as the picture shown.

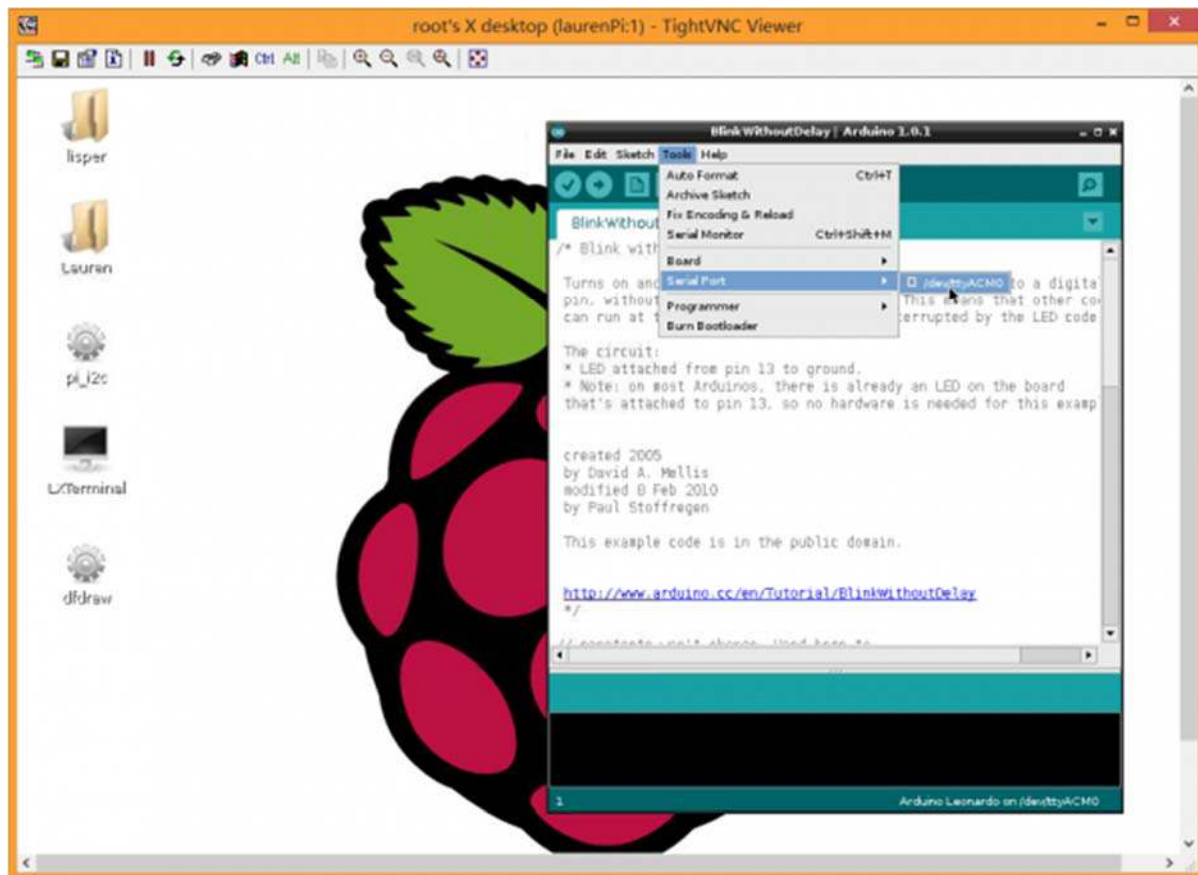

Fig2: Arduino IDE and program the shield

1. Click "Upload" to program it.

FAQ

Q1. Some general Arduino Problems/ FAQ/ Tips, very good to know.

A. Click [the topic link](#) on DFRobot Forum.

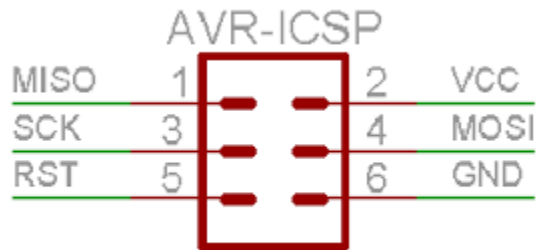

For Q2.ICSP interface pin definition

Q2. SPI devices not working on this expansion shield? I have been working around with the microSD card reader (cod. dfr0229) and this expansion shield. The arduino works great, I even have a lcd display working without any problem, but the SD card reader doesn't seem to work so well, I have connected it to the icsp pins (D4,11,12,13, 5V&GND). [His post link on Forum](#).

A. Note that the **SPI pins of Leonardo** are **not** connected to any of the digital I/O pins as they are on the Uno, they are only available on the ICSP connector. [From Arduino.cc](#)

For any question/advice/cool idea to share, please visit [DFRobot Forum](#).