

# 5.5 V ESD Protection Diode

## Micro-Packaged Diodes for ESD Protection

### ESDM3551

The ESDM3551 is designed to protect voltage sensitive components that require low capacitance from ESD and transient voltage events. Excellent clamping capability, low capacitance, low leakage, and fast response time, make these parts ideal for ESD protection on designs where board space is at a premium.

#### Features

- Low Clamping Voltage
- Small Body Outline Dimensions:
  - 0201: 0.62 mm x 0.32 mm
  - 0402: 1.00 mm x 0.60 mm
- Low Body Height: 0.3 mm
- Stand-off Voltage: 5.5 V
- IEC61000-4-2 Level 4 ESD Protection
- SZ Prefix for Automotive and Other Applications Requiring Unique Site and Control Change Requirements; AEC-Q101 Qualified and PPAP Capable
- These Devices are Pb-Free, Halogen Free/BFR Free and are RoHS Compliant

#### Typical Applications

- USB ID Line Protection
- $\mu$ SD Card Protection
- Audio Line Protection
- GPIO

#### MAXIMUM RATINGS

Rating	Symbol	Value	Unit
IEC 61000-4-2 Contact IEC 61000-4-2 Air ISO 10605 150 pF/2 k $\Omega$ ISO 10605 330 pF/2 k $\Omega$ ISO 10605 330 pF/330 $\Omega$	ESD	$\pm 30$ $\pm 30$ $\pm 30$ $\pm 30$ $\pm 30$	kV
Total Power Dissipation on FR-5 Board (Note 1) @ $T_A = 25^\circ\text{C}$	$P_D$	250	mW
Thermal Resistance, Junction-to-Ambient	$R_{\theta JA}$	400	$^\circ\text{C/W}$
Junction and Storage Temperature Range	$T_J, T_{stg}$	-55 to +150	$^\circ\text{C}$
Lead Solder Temperature – Maximum (10 Second Duration)	$T_L$	260	$^\circ\text{C}$

Stresses exceeding those listed in the Maximum Ratings table may damage the device. If any of these limits are exceeded, device functionality should not be assumed, damage may occur and reliability may be affected.

1. FR-5 = 1.0 x 0.75 x 0.62 in.



X3DFN2 (0201)  
CASE 152AF



X2DFN2 (0402)  
CASE 714AB

#### MARKING DIAGRAMS

PIN 1



5 = Specific Device Code  
M = Date Code

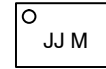

JJ = Specific Device Code  
M = Date Code



#### ORDERING INFORMATION

Device	Package	Shipping <sup>†</sup>
ESDM3551MXT5G	X3DFN2 (Pb-Free)	10000 / Tape & Reel
ESDM3551N2T5G	X2DFN2 (Pb-Free)	8000 / Tape & Reel
SZESDM3551N2T5G	X2DFN2 (Pb-Free)	8000 / Tape & Reel
SZESDM3551MXT5G	X3DFN2 (Pb-Free)	10000 / Tape & Reel

<sup>†</sup>For information on tape and reel specifications, including part orientation and tape sizes, please refer to our Tape and Reel Packaging Specifications Brochure, [BRD8011/D](#).

See Application Note [AND8308/D](#) for further description of survivability specs.

**ELECTRICAL CHARACTERISTICS**

( $T_A = 25^\circ\text{C}$  unless otherwise noted)

Symbol	Parameter
$I_{PP}$	Maximum Reverse Peak Pulse Current
$V_C$	Clamping Voltage @ $I_{PP}$
$V_{RWM}$	Working Peak Reverse Voltage
$I_R$	Maximum Reverse Leakage Current @ $V_{RWM}$
$V_{BR}$	Breakdown Voltage @ $I_T$
$I_T$	Test Current

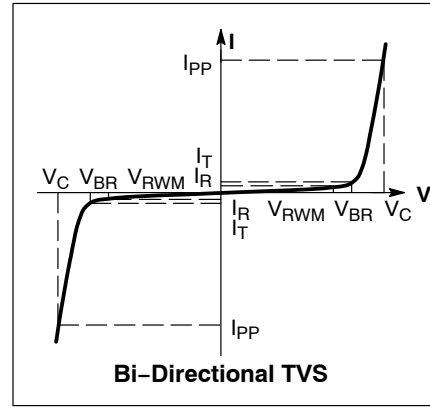

\*See Application Note [AND8308/D](#) for detailed explanations of datasheet parameters.

**ELECTRICAL CHARACTERISTICS** ( $T_A = 25^\circ\text{C}$  unless otherwise specified)

Parameter	Symbol	Conditions	Min	Typ	Max	Unit
Reverse Working Voltage	$V_{RWM}$				5.5	V
Breakdown Voltage (Note 2)	$V_{BR}$	$I_T = 1\text{ mA}$	5.6		7.0	V
Reverse Leakage Current	$I_R$	$V_{RWM} = 5.5\text{ V}$			0.1	$\mu\text{A}$
Clamping Voltage (Note 3)	$V_C$	$I_{PP} = 1\text{ A}$			6.0	V
Clamping Voltage (Note 3)	$V_C$	$I_{PP} = 8\text{ A}$			8.2	V
Peak Pulse Current (Note 3)	$I_{PP}$	$t_p = 8/20\ \mu\text{s}$	9.9			A
Clamping Voltage TLP (Note 4)	$V_C$	$I_{PP} = 16\text{ A}$ } IEC 61000-4-2 Level 4 equivalent ( $\pm 8\text{ kV Contact, } \pm 15\text{ kV Air}$ )		7.5		V
Junction Capacitance	$C_J$	$V_R = 0\text{ V, } f = 1\text{ MHz}$			21	pF
Dynamic Resistance	$R_{DYN}$	TLP Pulse		0.11		$\Omega$
Insertion Loss		$f = 10\text{ MHz}$		0.01		dB

Product parametric performance is indicated in the Electrical Characteristics for the listed test conditions, unless otherwise noted. Product performance may not be indicated by the Electrical Characteristics if operated under different conditions.

- Breakdown voltage is tested from pin 1 to 2 and pin 2 to 1.
- Non-repetitive current pulse at  $T_A = 25^\circ\text{C}$ , per IEC61000-4-5 waveform.
- ANSI/ESD STM5.5.1 – Electrostatic Discharge Sensitivity Testing using Transmission Line Pulse (TLP) Model.  
TLP conditions:  $Z_0 = 50\ \Omega$ ,  $t_p = 100\text{ ns}$ ,  $t_r = 4\text{ ns}$ , averaging window;  $t_1 = 30\text{ ns}$  to  $t_2 = 60\text{ ns}$ .

**TYPICAL CHARACTERISTICS**

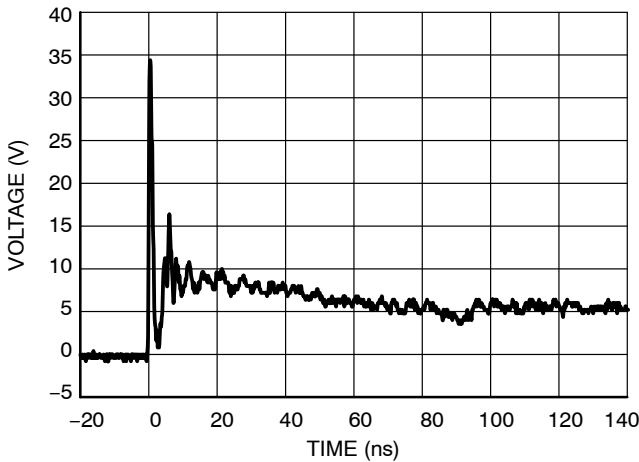

**Figure 1. ESD Clamping Voltage Screenshot Positive 8 kV Contact per IEC61000-4-2**

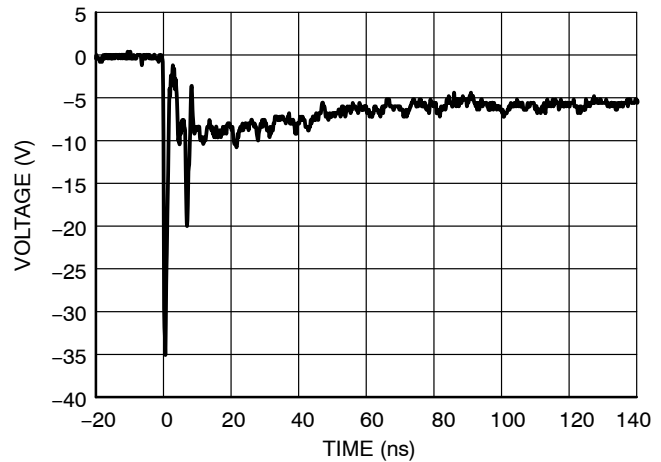

**Figure 2. ESD Clamping Voltage Screenshot Negative 8 kV Contact per IEC61000-4-2**

TYPICAL CHARACTERISTICS (continued)

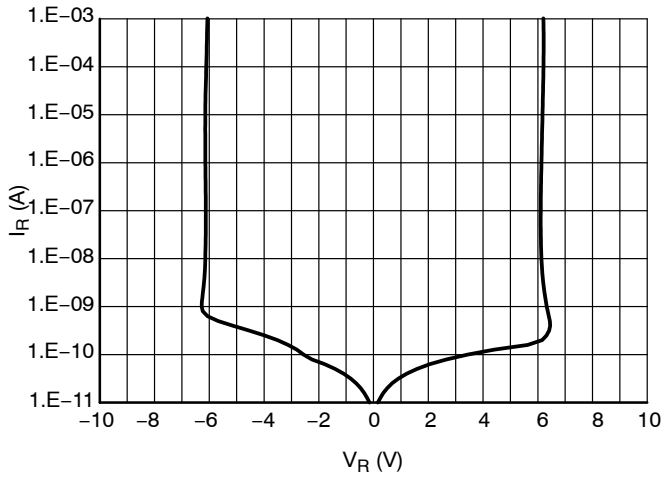

Figure 3. IV Characteristics

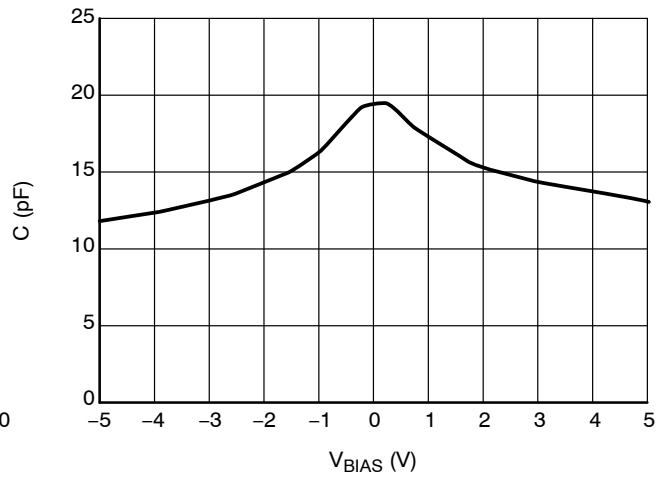

Figure 4. CV Characteristics

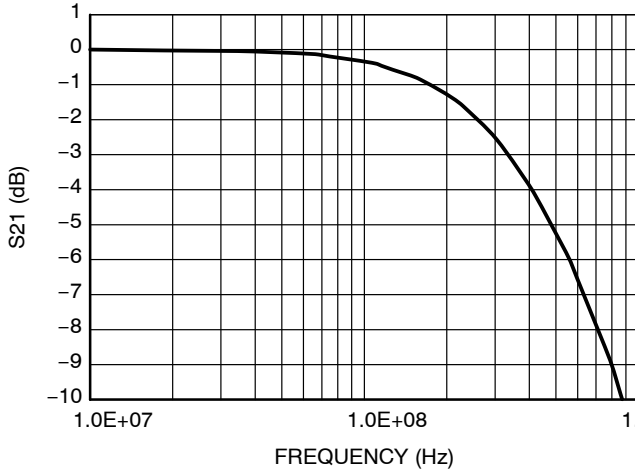

Figure 5. RF Insertion Loss

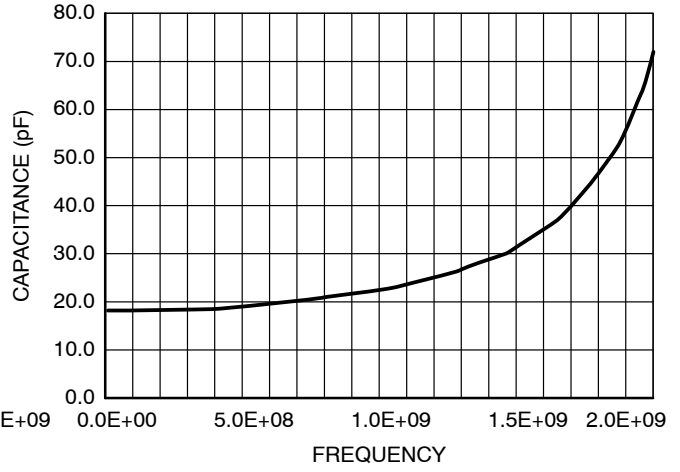

Figure 6. Capacitance over Frequency

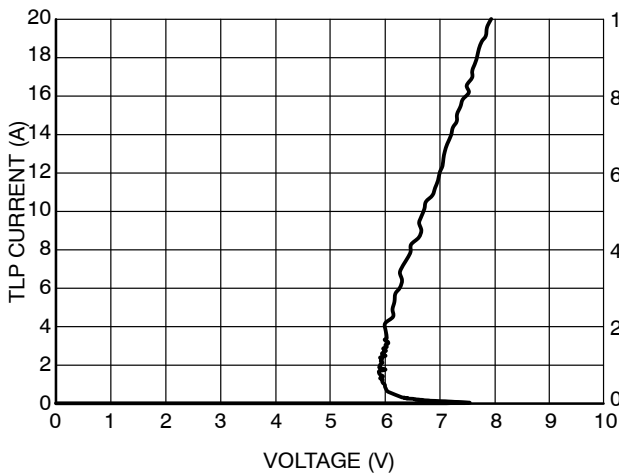

Figure 7. Positive TLP I-V Curve

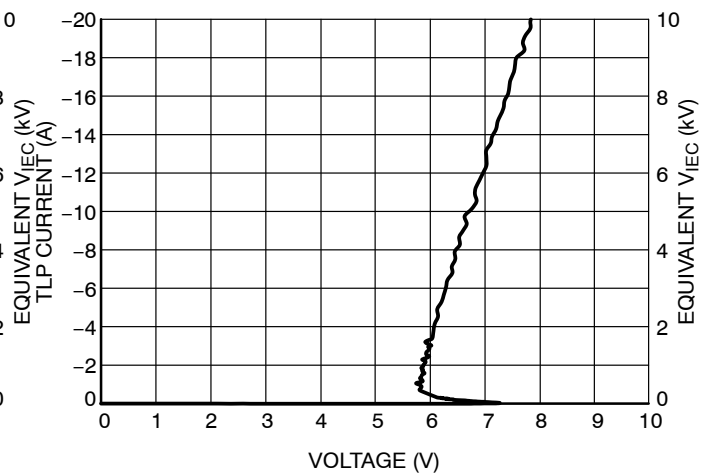

Figure 8. Negative TLP I-V Curve

TYPICAL CHARACTERISTICS (continued)

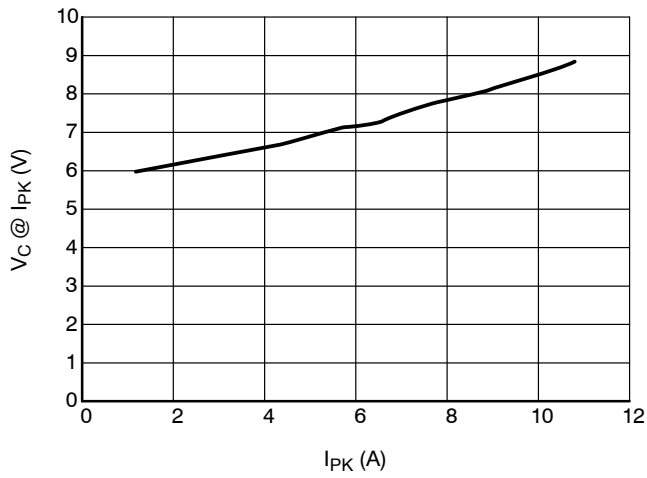

Figure 9. Positive Clamping Voltage vs. Peak Pulse Current ( $t_p = 8/20 \mu s$ )

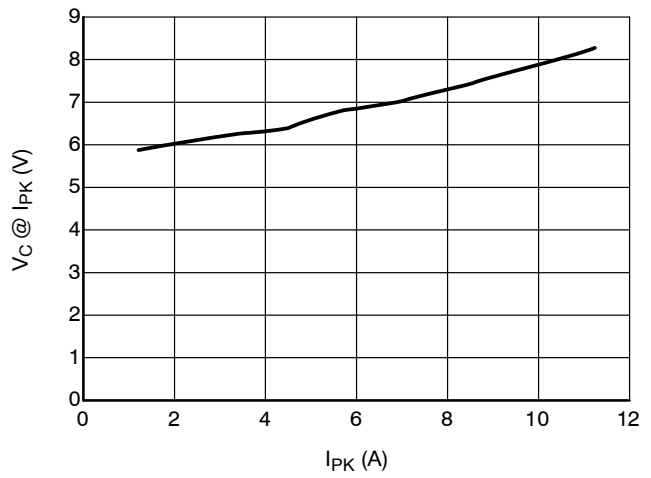

Figure 10. Negative Clamping Voltage vs. Peak Pulse Current ( $t_p = 8/20 \mu s$ )

IEC 61000-4-2 Spec.

Level	Test Voltage (kV)	First Peak Current (A)	Current at 30 ns (A)	Current at 60 ns (A)
1	2	7.5	4	2
2	4	15	8	4
3	6	22.5	12	6
4	8	30	16	8

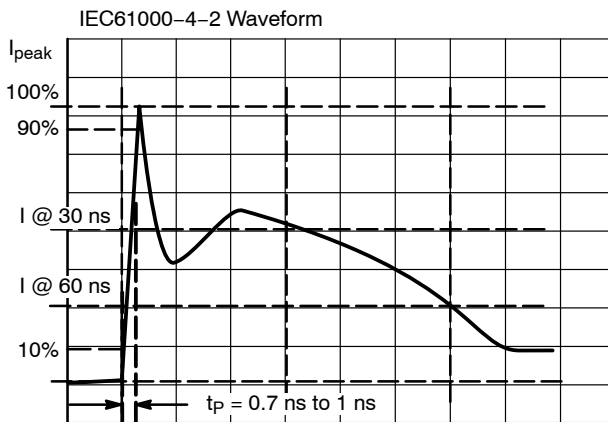

Figure 11. IEC61000-4-2 Spec

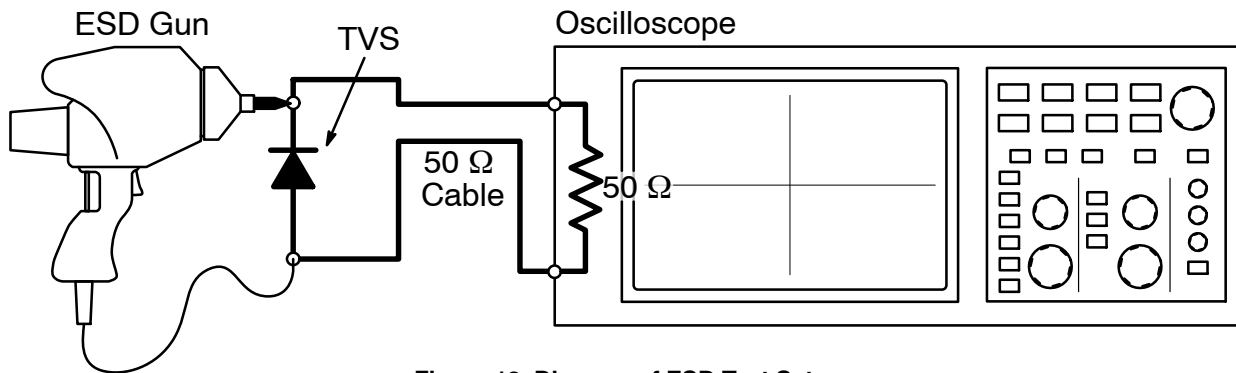

Figure 12. Diagram of ESD Test Setup

ESD Voltage Clamping

For sensitive circuit elements it is important to limit the voltage that an IC will be exposed to during an ESD event to as low a voltage as possible. The ESD clamping voltage is the voltage drop across the ESD protection diode during an ESD event per the IEC61000-4-2 waveform. Since the IEC61000-4-2 was written as a pass/fail spec for larger systems such as cell phones or laptop computers it is not

clearly defined in the spec how to specify a clamping voltage at the device level. **onsemi** has developed a way to examine the entire voltage waveform across the ESD protection diode over the time domain of an ESD pulse in the form of an oscilloscope screenshot, which can be found on the datasheets for all ESD protection diodes. For more information on how **onsemi** creates these screenshots and how to interpret them please refer to [AND8307/D](#).

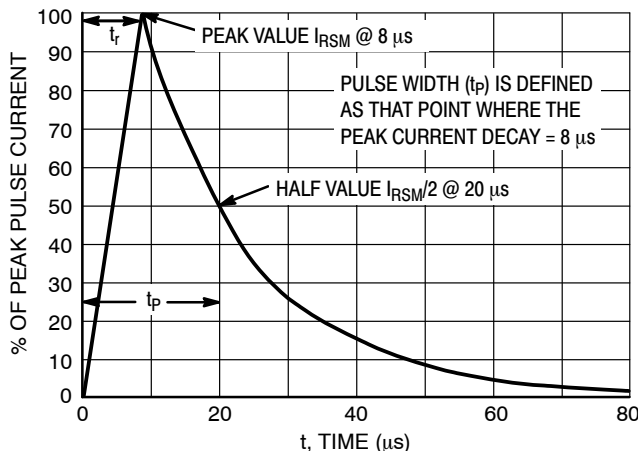
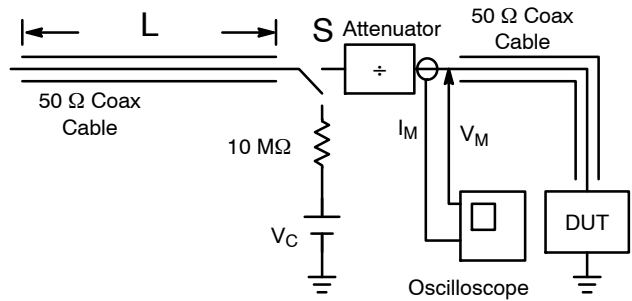

Figure 13. 8 X 20 μs Pulse Waveform

**Transmission Line Pulse (TLP) Measurement**

Transmission Line Pulse (TLP) provides current versus voltage (I-V) curves in which each data point is obtained from a 100 ns long rectangular pulse from a charged transmission line. A simplified schematic of a typical TLP system is shown in Figure 14. TLP I-V curves of ESD protection devices accurately demonstrate the product’s ESD capability because the 10s of amps current levels and under 100 ns time scale match those of an ESD event. This is illustrated in Figure 15 where an 8 kV IEC 61000-4-2 current waveform is compared with TLP current pulses at 8 A and 16 A. A TLP I-V curve shows the voltage at which the device turns on as well as how well the device clamps voltage over a range of current levels.



**Figure 14. Simplified Schematic of a Typical TLP System**

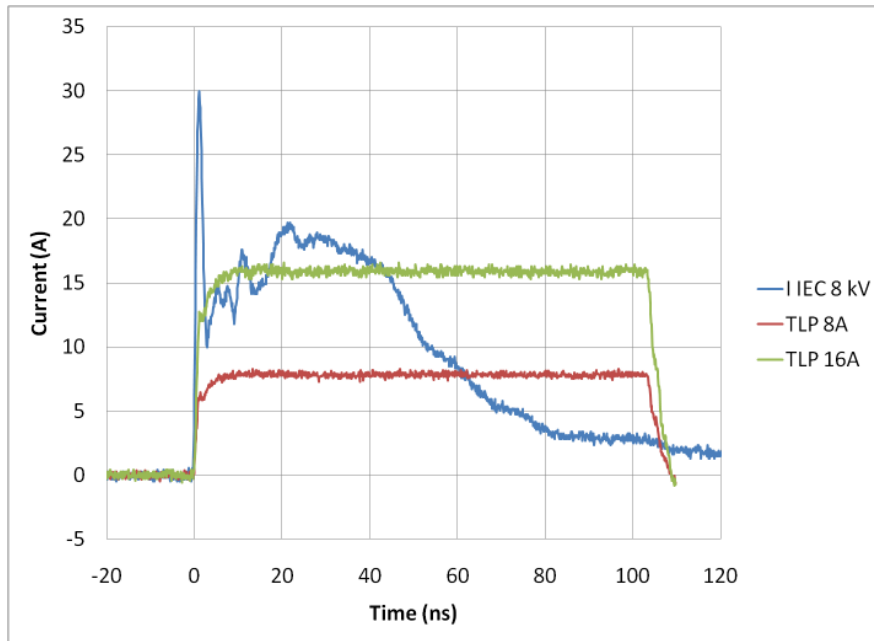

**Figure 15. Comparison Between 8 kV IEC 61000-4-2 and 8 A and 16 A TLP Waveforms**

# MECHANICAL CASE OUTLINE

## PACKAGE DIMENSIONS



**X3DFN2 0.62x0.32x0.24, 0.35P**  
**CASE 152AF**  
**ISSUE C**

DATE 08 AUG 2023

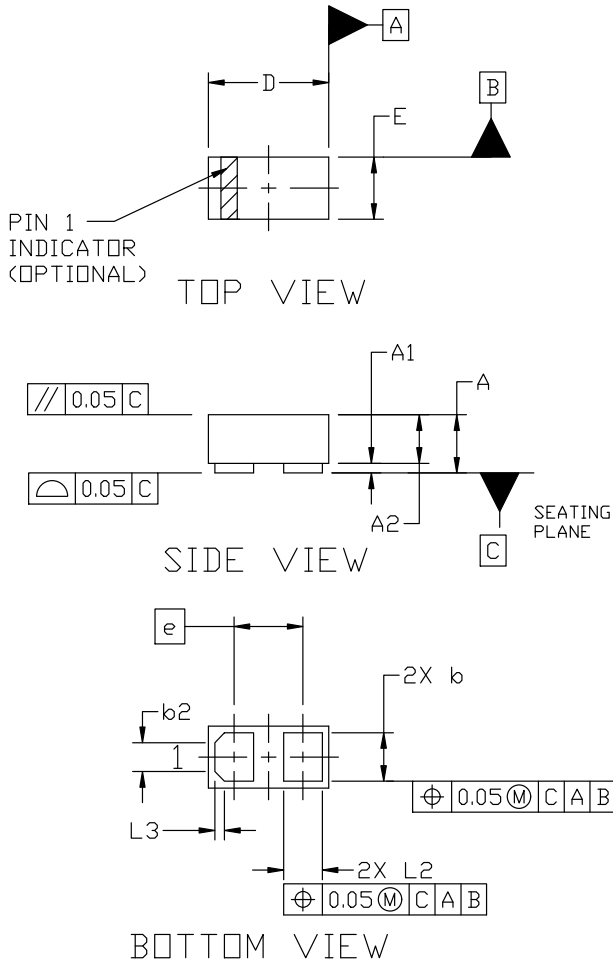

**NOTES:**

1. DIMENSIONING AND TOLERANCING PER ASME Y14.5M, 1994.
2. CONTROLLING DIMENSION: MILLIMETERS
3. 0201

MILLIMETERS			
DIM	MIN.	NOM.	MAX.
A	0.25	0.29	0.33
A1	0.00	---	0.05
A2	0.14	0.24	0.34
b	0.22	0.25	0.28
b2	0.150 REF		
D	0.58	0.62	0.66
E	0.28	0.32	0.36
e	0.355 BSC		
L2	0.17	0.20	0.23
L3	0.050 REF		

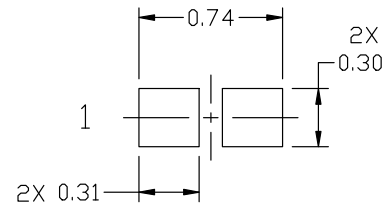

**GENERIC MARKING DIAGRAM\***



X = Specific Device Code  
M = Date Code

\*This information is generic. Please refer to device data sheet for actual part marking. Pb-Free indicator, "G" or microdot "•", may or may not be present. Some products may not follow the Generic Marking.

\* For additional information on our Pb-Free strategy and soldering details, please download the ON Semiconductor Soldering and Mounting Techniques Reference Manual, SOLDERRM/D.

<b>DOCUMENT NUMBER:</b>	<b>98AON56472E</b>	Electronic versions are uncontrolled except when accessed directly from the Document Repository. Printed versions are uncontrolled except when stamped "CONTROLLED COPY" in red.
<b>DESCRIPTION:</b>	<b>X3DFN2 0.62x0.32x0.24, 0.35P</b>	<b>PAGE 1 OF 1</b>

onsemi and ONSEMI are trademarks of Semiconductor Components Industries, LLC dba onsemi or its subsidiaries in the United States and/or other countries. onsemi reserves the right to make changes without further notice to any products herein. onsemi makes no warranty, representation or guarantee regarding the suitability of its products for any particular purpose, nor does onsemi assume any liability arising out of the application or use of any product or circuit, and specifically disclaims any and all liability, including without limitation special, consequential or incidental damages. onsemi does not convey any license under its patent rights nor the rights of others.

# MECHANICAL CASE OUTLINE

## PACKAGE DIMENSIONS

ON Semiconductor®



SCALE 8:1

X2DFN2 1.0x0.6, 0.65P  
CASE 714AB  
ISSUE B

DATE 21 NOV 2017

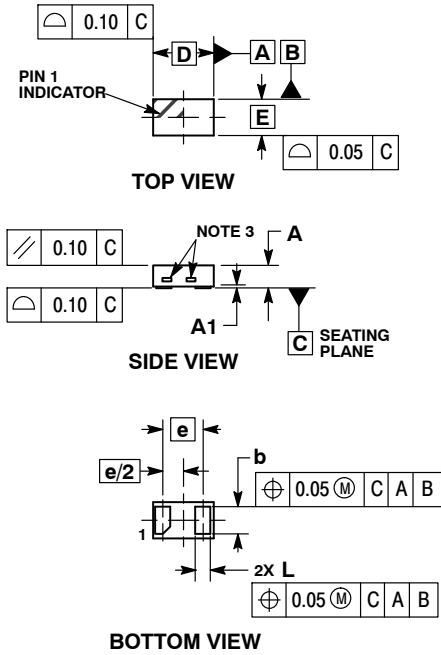

NOTES:

1. DIMENSIONING AND TOLERANCING PER ASME Y14.5M, 1994.
2. CONTROLLING DIMENSION: MILLIMETERS.
3. EXPOSED COPPER ALLOWED AS SHOWN.

DIM	MILLIMETERS		
	MIN	NOM	MAX
A	0.34	0.37	0.40
A1	---	0.03	0.05
b	0.45	0.50	0.55
D	0.95	1.00	1.05
E	0.55	0.60	0.65
e	0.65 BSC		
L	0.20	0.25	0.30

**GENERIC MARKING DIAGRAM\***

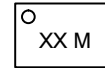

XX = Specific Device Code  
M = Date Code

**RECOMMENDED SOLDER FOOTPRINT\***

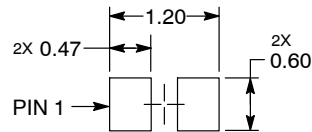

DIMENSIONS: MILLIMETERS

\*This information is generic. Please refer to device data sheet for actual part marking. Pb-Free indicator, "G" or microdot "▪", may or may not be present. Some products may not follow the Generic Marking.

<b>DOCUMENT NUMBER:</b>	<b>98AON98172F</b>	Electronic versions are uncontrolled except when accessed directly from the Document Repository. Printed versions are uncontrolled except when stamped "CONTROLLED COPY" in red.
<b>DESCRIPTION:</b>	<b>X2DFN2 1.0X0.6, 0.65P</b>	<b>PAGE 1 OF 1</b>

ON Semiconductor and are trademarks of Semiconductor Components Industries, LLC dba ON Semiconductor or its subsidiaries in the United States and/or other countries. ON Semiconductor reserves the right to make changes without further notice to any products herein. ON Semiconductor makes no warranty, representation or guarantee regarding the suitability of its products for any particular purpose, nor does ON Semiconductor assume any liability arising out of the application or use of any product or circuit, and specifically disclaims any and all liability, including without limitation special, consequential or incidental damages. ON Semiconductor does not convey any license under its patent rights nor the rights of others.



**onsemi**, **Onsemi**, and other names, marks, and brands are registered and/or common law trademarks of Semiconductor Components Industries, LLC dba "**onsemi**" or its affiliates and/or subsidiaries in the United States and/or other countries. **onsemi** owns the rights to a number of patents, trademarks, copyrights, trade secrets, and other intellectual property. A listing of **onsemi**'s product/patent coverage may be accessed at [www.onsemi.com/site/pdf/Patent-Marking.pdf](http://www.onsemi.com/site/pdf/Patent-Marking.pdf). **onsemi** reserves the right to make changes at any time to any products or information herein, without notice. The information herein is provided "as-is" and **onsemi** makes no warranty, representation or guarantee regarding the accuracy of the information, product features, availability, functionality, or suitability of its products for any particular purpose, nor does **onsemi** assume any liability arising out of the application or use of any product or circuit, and specifically disclaims any and all liability, including without limitation special, consequential or incidental damages. Buyer is responsible for its products and applications using **onsemi** products, including compliance with all laws, regulations and safety requirements or standards, regardless of any support or applications information provided by **onsemi**. "Typical" parameters which may be provided in **onsemi** data sheets and/or specifications can and do vary in different applications and actual performance may vary over time. All operating parameters, including "Typicals" must be validated for each customer application by customer's technical experts. **onsemi** does not convey any license under any of its intellectual property rights nor the rights of others. **onsemi** products are not designed, intended, or authorized for use as a critical component in life support systems or any FDA Class 3 medical devices or medical devices with a same or similar classification in a foreign jurisdiction or any devices intended for implantation in the human body. Should Buyer purchase or use **onsemi** products for any such unintended or unauthorized application, Buyer shall indemnify and hold **onsemi** and its officers, employees, subsidiaries, affiliates, and distributors harmless against all claims, costs, damages, and expenses, and reasonable attorney fees arising out of, directly or indirectly, any claim of personal injury or death associated with such unintended or unauthorized use, even if such claim alleges that **onsemi** was negligent regarding the design or manufacture of the part. **onsemi** is an Equal Opportunity/Affirmative Action Employer. This literature is subject to all applicable copyright laws and is not for resale in any manner.

---

## ADDITIONAL INFORMATION

### TECHNICAL PUBLICATIONS:

Technical Library: [www.onsemi.com/design/resources/technical-documentation](http://www.onsemi.com/design/resources/technical-documentation)  
onsemi Website: [www.onsemi.com](http://www.onsemi.com)

### ONLINE SUPPORT: [www.onsemi.com/support](http://www.onsemi.com/support)

For additional information, please contact your local Sales Representative at [www.onsemi.com/support/sales](http://www.onsemi.com/support/sales)