

**Dual Operational Amplifiers for Commercial  
Industrial, and Military Applications**

March 1993

**Features**

- Internal Frequency Compensation for Unity Gain
- High DC Voltage Gain ..... 100dB (Typ.)
- Wide Bandwidth at Unity Gain ..... 1MHz (Typ.)
- Wide Power Supply Range:
  - Single Supply ..... 3 to 30V
  - Dual Supplies .....  $\pm 1.5$  to  $\pm 15V$
- Low Supply Current ..... 1.5 mA (Typ.)
- Low Input Bias Current
- Low Input Offset Voltage and Current
- Input Common-Mode Voltage Range Includes Ground
- Differential Input Voltage Range Equal to  $V+$  Range
- Large Output Voltage Swing ..... 0 to  $V+ - 1.5V$

**Description**

The CA158, CA158A, CA258, CA258A, CA358, CA358A and CA2904 types consist of two independent, high gain, internally frequency compensated operational amplifiers which are designed specifically to operate from a single power supply over a wide range of voltages. They may also be operated from split power supplies. The supply current is basically independent of the supply voltage over the recommended voltage range.

These devices are particularly useful in interface circuits with digital systems and can be operated from the single common  $5V_{DC}$  power supply. They are also intended for transducer amplifiers, DC gain blocks and many other conventional op amp circuits which can benefit from the single power supply capability.

The CA158, CA158A, CA258, CA258A, CA358, CA358A, and CA2904 types are an equivalent to or a replacement for the industry types 158, 158A, 258, 258A, 358, 358A, and CA2904.

**Ordering Information**

PART NUMBER	SUFFIX LETTERS	PACKAGE
CA158, A CA258, A CA358, A CA2904	E	8 Lead Plastic DIP
	M	8 Lead SOIC
CA158, A CA258, A CA358, A	T	8 Pin TO-5 Can with Standard Leads
	S	8 Pin TO-5 Can with Dual-In-Line Formed Leads

**Pinouts**

CA158, CA258, and CA358 (TO-5 CAN)  
TOP VIEW

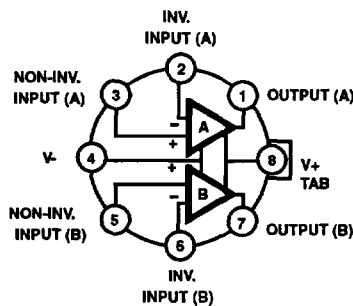

CA158, CA258, CA358, AND CA2904 (PDIP, SOIC)  
TOP VIEW

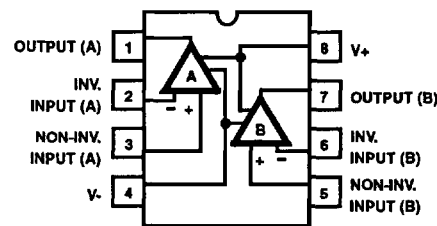

\* Technical Data on LM Branded types is identical to the corresponding CA Branded types.  
CAUTION: These devices are sensitive to electrostatic discharge. Users should follow proper I.C. Handling Procedures.  
Copyright © Harris Corporation 1993

**Specifications CA158, CA158A, CA258, CA258A, CA358, CA358A, CA2904, LM358, LM2904**

**Absolute Maximum Ratings**

Supply Voltage (Note 5)  
 CA2904 ..... 26V or ±13V  
 Other Types ..... 32V or ±16V  
 Differential Input Voltage (All Types) ..... 32V  
 Input Voltage ..... -0.3V to V+V  
 Input Current ( $V_I < -0.3V$ ) (Note 5) ..... 50mA  
 Output Short Circuit Duration ( $V+ \leq 15V$ ) (Note 6) ..... Continuous  
 Power Dissipation  
 Up to  $T_A = -55^\circ C$  ..... 630mW  
 Above  $T_A = -55^\circ C$  ..... Derate Linearly at 6.67 mW/°C  
 Junction Temperature ..... +175°C  
 Junction Temperature (Plastic Package) ..... +150°C  
 Lead Temperature ( Soldering 10 Sec.) ..... +300°C

**Operating Conditions**

Operating Temperature Range ..... -55°C to +125°C  
 Storage Temperature Range ..... -65°C to +150°C

*CAUTION: Stresses above those listed in "Absolute Maximum Ratings" may cause permanent damage to the device. This is a stress only rating and operation of the device at these or any other conditions above those indicated in the operational sections of this specification is not implied.*

**Electrical Specifications** Values Apply for Each Operational Amplifier, Supply Voltage (V+) = 5V, Unless Otherwise Specified

PARAMETERS	SYMBOL	TEST CONDITIONS	CA158A LIMITS			UNITS
			MIN	TYP	MAX	
$T_A = +25^\circ C$						
Input Offset Voltage	$V_{IO}$	(Note 3)	-	1	2	mV
Output Voltage Swing	$V_{OPP}$	$R_L = 2k\Omega$	0	-	$V+ - 1.5$	V
Input Common Mode Voltage Range	$V_{ICR}$	(Note 2), $V+ = 30V$	0	-	$V+ - 1.5$	V
Input Offset Current	$I_{IO}$	$I_{I+} - I_{I-}$	-	2	10	nA
Input Bias Current	$I_{IB}$	$I_{I+}$ or $I_{I-}$ , (Note 1)	-	20	50	nA
Output Current (Source)	$I_O$	$V_{I+} = +1V, V_{I-} = 0V, V+ = 15V$	20	40	-	mA
Output Current (Sink)	$I_O$	$V_{I+} = 0V, V_{I-} = 1V, V+ = 15V$	10	20	-	mA
		$V_{I+} = 0V, V_{I-} = 1V, V_O = 200mV$	12	50	-	$\mu A$
Short Circuit Output Current		$R_L = 0\Omega$ (to Ground) (Note 4)	-	40	60	mA
Large Signal Voltage Gain	$A_{OL}$	$R_L \geq 2k\Omega, V+ = 15V$ (For large $V_O$ swing)	50	100	-	V/mV
Common Mode Rejection Ratio	CMRR	DC	70	85	-	dB
Power Supply Rejection Ratio	PSRR	DC	65	100	-	dB
Amplifier-to-Amplifier Coupling		$f = 1$ to 20kHz (Input referred)	-	-120	-	dB
$T_A = -55^\circ C$ to $+125^\circ C$						
Input Offset Voltage	$V_{IO}$	(Note 3)	-	-	4	mV
Temperature Coefficient of Input Offset Voltage	$\infty V_{IO}$	$R_S = 0\Omega$	-	7	15	$\mu V/^\circ C$
Input Offset Current	$I_{IO}$	$I_{I+} - I_{I-}$	-	-	30	nA
Temperature Coefficient of Input Offset Current	$\infty I_{IO}$		-	10	200	$pA/^\circ C$
Input Bias Current	$I_{IB}$	$I_{I+}$ or $I_{I-}$	-	40	100	nA
Input Common Mode Voltage Range	$V_{ICR}$	$V+ = 30V$ (Note 2)	0	-	$V+ - 2$	V

**2**  
OPERATIONAL AMPLIFIERS

**Specifications CA158, CA158A, CA258, CA258A, CA358, CA358A, CA2904, LM358, LM2904**

**Electrical Specifications** Values Apply for Each Operational Amplifier, Supply Voltage (V+) = 5V, Unless Otherwise Specified (Continued)

PARAMETERS	SYMBOL	TEST CONDITIONS	CA158A LIMITS			UNITS
			MIN	TYP	MAX	
Supply Current	I+	R <sub>L</sub> = ∞ On all amplifiers	-	0.7	1.2	mA
		R <sub>L</sub> = ∞, V+ = 30V	-	1.5	3	mA

**NOTES:**

1. Due to the p-n-p input stage the direction of the input current is out of the IC. No loading change exists on the input lines because this current is essentially constant, independent of the state of the output.
2. The input signal voltages and the input common mode voltage should not be allowed to go negative by more than 0.3V. The positive limit of the common mode voltage range is V+ - 1.5V, but either or both inputs can go to +32V without damage.
3. V<sub>O</sub> = 1.4V<sub>DC</sub>, R<sub>S</sub> = 0Ω with V+ from 5V to 30V; and over the full input common mode voltage range (0V to V+ - 1.5V).
4. The maximum output current is approximately 40mA independent of the magnitude of V+. Continuous short circuits at V+ > 15V can cause excessive power dissipation and eventual destruction. Short circuits from the output to V+ can cause overheating and eventual destruction of the device. Destructive dissipation can result from simultaneous short circuits on both amplifiers.
5. This input current will only exist when the voltage at any of the input leads is driven negative. This current is due to the collector base junction of the input p-n-p transistors becoming forward biased and thereby acting as input diode clamps. In addition to this diode action, there is also lateral n-p-n parasitic transistor action on the IC chip. This transistor action can cause the output voltages of the amplifiers to go to the V+ voltage level (or to ground for a large overdrive) for the time duration that an input is driven negative. This transistor action is not destructive and normal output states will re-establish when the input voltage, which was negative, again returns to a value greater than -0.3V<sub>DC</sub>.
6. The maximum output current is approximately 40mA independent of the magnitude of V+. Continuous short circuits at V+ > 15V can cause excessive power dissipation and eventual destruction. Short circuits from the output to V+ can cause overheating and eventual destruction of the device. Destructive dissipation can result from simultaneous short circuits on both amplifiers.

**Electrical Specifications** Values Apply for Each Operational Amplifier, Supply Voltage (V+) = 5V, Unless Otherwise Specified

PARAMETERS	SYMBOL	TEST CONDITIONS	CA258A LIMITS			UNITS
			MIN	TYP	MAX	
T <sub>A</sub> = +25°C						
Input Offset Voltage	V <sub>IO</sub>	(Note 3)	-	1	3	mV
Output Voltage Swing	V <sub>OPP</sub>	R <sub>L</sub> = 2kΩ	0	-	V+ - 1.5	V
Input Common Mode Voltage Range	V <sub>ICR</sub>	(Note 2), V+ = 30V	0	-	V+ - 1.5	V
Input Offset Current	I <sub>IO</sub>	I <sub>I+</sub> - I <sub>I-</sub>	-	2	15	nA
Input Bias Current	I <sub>IB</sub>	I <sub>I+</sub> or I <sub>I-</sub> , (Note 1)	-	40	80	nA
Output Current (Source)	I <sub>O</sub>	V <sub>I+</sub> = +1V, V <sub>I-</sub> = 0V, V+ = 15V	20	40	-	mA
Output Current (Sink)	I <sub>O</sub>	V <sub>I+</sub> = 0V, V <sub>I-</sub> = 1V, V+ = 15V	10	20	-	mA
		V <sub>I+</sub> = 0V, V <sub>I-</sub> = 1V, V <sub>O</sub> = 200mV	12	50	-	μA
Short Circuit Output Current		R <sub>L</sub> = 0Ω (to Ground) (Note 4)	-	40	60	mA
Large Signal Voltage Gain	A <sub>OL</sub>	R <sub>L</sub> ≥ 2kΩ, V+ = 15V (For large V <sub>O</sub> swing)	50	100	-	V/mV
Common Mode Rejection Ratio	CMRR	DC	70	85	-	dB
Power Supply Rejection Ratio	PSRR	DC	65	100	-	dB
Amplifier-to-Amplifier Coupling		f = 1 to 20kHz (Input referred)	-	-120	-	dB
T <sub>A</sub> = -25°C to +85°C						
Input Offset Voltage	V <sub>IO</sub>	(Note 3)	-	-	4	mV
Temperature Coefficient of Input Offset Voltage	∞V <sub>IO</sub>	R <sub>S</sub> = 0Ω	-	7	15	μV/°C
Input Offset Current	I <sub>IO</sub>	I <sub>I+</sub> - I <sub>I-</sub>	-	-	30	nA

**Electrical Specifications** Values Apply for Each Operational Amplifier, Supply Voltage (V+) = 5V, Unless Otherwise Specified (Continued)

PARAMETERS	SYMBOL	TEST CONDITIONS	CA258A LIMITS			UNITS
			MIN	TYP	MAX	
Temperature Coefficient of Input Offset Current	$\infty I_{IO}$		-	10	200	pA/°C
Input Bias Current	$I_B$	$I_{I+}$ or $I_{I-}$	-	40	100	nA
Input Common Mode Voltage Range	$V_{ICR}$	$V_+ = 30V$ (Note 2)	0	-	$V_+ - 2$	V
Supply Current	$I_+$	$R_L = \infty$ On all amplifiers	-	0.7	1.2	mA
		$R_L = \infty, V_+ = 30V$	-	1.5	3	mA

NOTES:

1. Due to the p-n-p input stage the direction of the input current is out of the IC. No loading change exists on the input lines because this current is essentially constant, independent of the state of the output.
2. The input signal voltages and the input common mode voltage should not be allowed to go negative by more than 0.3V. The positive limit of the common mode voltage range is  $V_+ - 1.5V$ , but either or both inputs can go to +32V without damage.
3.  $V_O = 1.4V_{DC}$ ,  $R_S = 0\Omega$  with  $V_+$  from 5V to 30V; and over the full Input common mode voltage range (0V to  $V_+ - 1.5V$ ).
4. The maximum output current is approximately 40mA independent of the magnitude of  $V_+$ . Continuous short circuits at  $V_+ > 15V$  can cause excessive power dissipation and eventual destruction. Short circuits from the output to  $V_+$  can cause overheating and eventual destruction of the device. Destructive dissipation can result from simultaneous short circuits on both amplifiers.

**Electrical Specifications** Values Apply for Each Operational Amplifier, Supply Voltage (V+) = 5V, Unless Otherwise Specified

PARAMETERS	SYMBOL	TEST CONDITIONS	CA358A LIMITS			UNITS
			MIN	TYP	MAX	
$T_A = +25^\circ C$						
Input Offset Voltage	$V_{IO}$	(Note 3)	-	2	3	mV
Output Voltage Swing	$V_{OPP}$	$R_L = 2k\Omega$	0	-	$V_+ - 1.5$	V
Input Common Mode Voltage Range	$V_{ICR}$	(Note 2), $V_+ = 30V$	0	-	$V_+ - 1.5$	V
Input Offset Current	$I_{IO}$	$I_{I+} - I_{I-}$	-	5	30	nA
Input Bias Current	$I_B$	$I_{I+}$ or $I_{I-}$ , (Note 1)	-	45	100	nA
Output Current (Source)	$I_O$	$V_{I+} = +1V, V_{I-} = 0V, V_+ = 15V$	20	40	-	mA
Output Current (Sink)	$I_O$	$V_{I+} = 0V, V_{I-} = 1V, V_+ = 15V$	10	20	-	mA
		$V_{I+} = 0V, V_{I-} = 1V, V_O = 200mV$	12	50	-	$\mu A$
Short Circuit Output Current		$R_L = 0\Omega$ (to Ground) (Note 4)	-	40	60	mA
Large Signal Voltage Gain	$A_{OL}$	$R_L \geq 2k\Omega, V_+ = 15V$ (For large $V_O$ swing)	25	100	-	V/mV
Common Mode Rejection Ratio	CMRR	DC	65	85	-	dB
Power Supply Rejection Ratio	PSRR	DC	65	100	-	dB
Amplifier-to-Amplifier Coupling		$f = 1$ to 20kHz (Input referred)	-	-120	-	dB
$T_A = 0$ to $+70^\circ C$						
Input Offset Voltage	$V_{IO}$	(Note 3)	-	-	5	mV
Temperature Coefficient of Input Offset Voltage	$\infty V_{IO}$	$R_S = 0\Omega$	-	7	20	$\mu V/^\circ C$
Input Offset Current	$I_{IO}$	$I_{I+} - I_{I-}$	-	-	75	nA
Temperature Coefficient of Input Offset Current	$\infty I_{IO}$		-	10	300	pA/°C

**Specifications CA158, CA158A, CA258, CA258A, CA358, CA358A, CA2904, LM358, LM2904**

**Electrical Specifications** Values Apply for Each Operational Amplifier, Supply Voltage (V+) = 5V, Unless Otherwise Specified (Continued)

PARAMETERS	SYMBOL	TEST CONDITIONS	CA358A LIMITS			UNITS
			MIN	TYP	MAX	
Input Bias Current	$I_{IB}$	$I_{I+}$ or $I_{I-}$	-	40	200	nA
Input Common Mode Voltage Range	$V_{ICR}$	$V_+ = 30V$ (Note 2)	0	-	$V_+ - 2$	V
Supply Current	$I_+$	$R_L = \infty$ On all amplifiers	-	0.7	1.2	mA
		$R_L = \infty, V_+ = 30V$	-	1.5	3	mA

**NOTES:**

1. Due to the p-n-p input stage the direction of the input current is out of the IC. No loading change exists on the input lines because this current is essentially constant, independent of the state of the output.
2. The input signal voltages and the input common mode voltage should not be allowed to go negative by more than 0.3V. The positive limit of the common mode voltage range is  $V_+ - 1.5V$ , but either or both inputs can go to +32V without damage.
3.  $V_O = 1.4V_{OC}$ ,  $R_S = 0\Omega$  with  $V_+$  from 5V to 30V; and over the full input common mode voltage range (0V to  $V_+ - 1.5V$ ).
4. The maximum output current is approximately 40mA independent of the magnitude of  $V_+$ . Continuous short circuits at  $V_+ > 15V$  can cause excessive power dissipation and eventual destruction. Short circuits from the output to  $V_+$  can cause overheating and eventual destruction of the device. Destructive dissipation can result from simultaneous short circuits on both amplifiers.

**Electrical Specifications** Values Apply for Each Operational Amplifier, Supply Voltage (V+) = 5V, Unless Otherwise Specified

PARAMETERS	SYMBOL	TEST CONDITIONS	LIMITS CA158, CA258			UNITS
			MIN	TYP	MAX	
$T_A = +25^\circ C$						
Input Offset Voltage	$V_{IO}$	(Note 3)	-	2	5	mV
Output Voltage Swing	$V_{OPP}$	$R_L = 2k\Omega$	0	-	$V_+ - 1.5$	V
Input Common Mode Voltage Range	$V_{ICR}$	(Note 2), $V_+ = 30V$	0	-	$V_+ - 1.5$	V
Input Offset Current	$I_{IO}$	$I_{I+} - I_{I-}$	-	3	30	nA
Input Bias Current	$I_{IB}$	$I_{I+}$ or $I_{I-}$ , (Note 1)	-	45	150	nA
Output Current (Source)	$I_O$	$V_{I+} = +1V, V_{I-} = 0V, V_+ = 15V$	20	40	-	mA
Output Current (Sink)	$I_O$	$V_{I+} = 0V, V_{I-} = 1V, V_+ = 15V$	10	20	-	mA
		$V_{I+} = 0V, V_{I-} = 1V, V_O = 200mV$	12	50	-	$\mu A$
Short Circuit Output Current		$R_L = 0\Omega$ (to Ground) (Note 4)	-	40	60	mA
Large Signal Voltage Gain	$A_{OL}$	$R_L \geq 2k\Omega, V_+ = 15V$ (For large $V_O$ swing)	50	100	-	V/mV
Common Mode Rejection Ratio	CMRR	DC	70	85	-	dB
Power Supply Rejection Ratio	PSRR	DC	65	100	-	dB
Amplifier-to-Amplifier Coupling		$f = 1$ to 20kHz (Input referred)	-	-120	-	dB
$T_A = -55^\circ C$ to $+125^\circ C$ (CA158); $T_A = -25^\circ C$ to $+85^\circ C$ (CA258)						
Input Offset Voltage	$V_{IO}$	(Note 3)	-	-	7	mV
Temperature Coefficient of Input Offset Voltage	$\infty V_{IO}$	$R_S = 0\Omega$	-	7	-	$\mu V/^\circ C$
Input Offset Current	$I_{IO}$	$I_{I+} - I_{I-}$	-	-	100	nA
Temperature Coefficient of Input Offset Current	$\infty I_{IO}$		-	10	-	$pA/^\circ C$

**Specifications CA158, CA158A, CA258, CA258A, CA358, CA358A, CA2904, LM358, LM2904**

**Electrical Specifications** Values Apply for Each Operational Amplifier, Supply Voltage (V+) = 5V, Unless Otherwise Specified (Continued)

PARAMETERS	SYMBOL	TEST CONDITIONS	LIMITS CA158, CA258			UNITS
			MIN	TYP	MAX	
Input Bias Current	$I_{IB}$	$I_{I+}$ or $I_{I-}$	-	40	300	nA
Input Common Mode Voltage Range	$V_{ICR}$	$V_+ = 30V$ (Note 2)	0	-	$V_+ - 2$	V
Supply Current	$I_+$	$R_L = \infty$ On all amplifiers	-	0.7	1.2	mA
		$R_L = \infty, V_+ = 30V$	-	1.5	3	mA

**NOTES:**

1. Due to the p-n-p input stage the direction of the input current is out of the IC. No loading change exists on the input lines because this current is essentially constant, independent of the state of the output.
2. The input signal voltages and the input common mode voltage should not be allowed to go negative by more than 0.3V. The positive limit of the common mode voltage range is  $V_+ - 1.5V$ , but either or both inputs can go to +32V without damage.
3.  $V_O = 1.4V_{DC}$ ,  $R_S = 0\Omega$  with  $V_+$  from 5V to 30V; and over the full input common mode voltage range (0V to  $V_+ - 1.5V$ ).
4. The maximum output current is approximately 40mA independent of the magnitude of  $V_+$ . Continuous short circuits at  $V_+ > 15V$  can cause excessive power dissipation and eventual destruction. Short circuits from the output to  $V_+$  can cause overheating and eventual destruction of the device. Destructive dissipation can result from simultaneous short circuits on both amplifiers.

**Electrical Specifications** Values Apply for Each Operational Amplifier, Supply Voltage (V+) = 5V, Unless Otherwise Specified

PARAMETERS	SYMBOL	TEST CONDITIONS	CA358 LIMITS			UNITS
			MIN	TYP	MAX	
$T_A = +25^\circ C$						
Input Offset Voltage	$V_{IO}$	(Note 3)	-	2	7	mV
Output Voltage Swing	$V_{OPP}$	$R_L = 2k\Omega$	0	-	$V_+ - 1.5$	V
Input Common Mode Voltage Range	$V_{ICR}$	(Note 2), $V_+ = 30V$	0	-	$V_+ - 1.5$	V
Input Offset Current	$I_{IO}$	$I_{I+} - I_{I-}$	-	5	50	nA
Input Bias Current	$I_{IB}$	$I_{I+}$ or $I_{I-}$ , (Note 1)	-	45	250	nA
Output Current (Source)	$I_O$	$V_{I+} = +1V, V_{I-} = 0V, V_+ = 15V$	20	40	-	mA
Output Current (Sink)	$I_O$	$V_{I+} = 0V, V_{I-} = 1V, V_+ = 15V$	10	20	-	mA
		$V_{I+} = 0V, V_{I-} = 1V, V_O = 200mV$	12	50	-	$\mu A$
Short Circuit Output Current		$R_L = 0\Omega$ (to Ground) (Note 4)	-	40	60	mA
Large Signal Voltage Gain	$A_{OL}$	$R_L \geq 2k\Omega, V_+ = 15V$ (For large $V_O$ swing)	25	100	-	V/mV
Common Mode Rejection Ratio	CMRR	DC	65	70	-	dB
Power Supply Rejection Ratio	PSRR	DC	65	100	-	dB
Amplifier-to-Amplifier Coupling		$f = 1$ to 20kHz (input referred)	-	-120	-	dB
$T_A = 0$ to $+70^\circ C$						
Input Offset Voltage	$V_{IO}$	(Note 3)	-	-	9	mV
Temperature Coefficient of Input Offset Voltage	$\propto V_{IO}$	$R_S = 0\Omega$	-	7	-	$\mu V/^\circ C$
Input Offset Current	$I_{IO}$	$I_{I+} - I_{I-}$	-	-	150	nA
Temperature Coefficient of Input Offset Current	$\propto I_{IO}$		-	10	-	$pA/^\circ C$

**2**  
**OPERATIONAL AMPLIFIERS**

**Specifications CA158, CA158A, CA258, CA258A, CA358, CA358A, CA2904, LM358, LM2904**

**Electrical Specifications** Values Apply for Each Operational Amplifier, Supply Voltage (V+) = 5V, Unless Otherwise Specified (Continued)

PARAMETERS	SYMBOL	TEST CONDITIONS	CA358 LIMITS			UNITS
			MIN	TYP	MAX	
Input Bias Current	$I_{IB}$	$I_{I+}$ or $I_{I-}$	-	40	500	nA
Input Common Mode Voltage Range	$V_{ICR}$	$V_+ = 30V$ (Note 2)	0	-	$V_+ - 2$	V
Supply Current	$I_+$	$R_L = \infty$ On all amplifiers	-	0.7	1.2	mA
		$R_L = \infty, V_+ = 30V$	-	1.5	3	mA

NOTES:

1. Due to the p-n-p input stage the direction of the input current is out of the IC. No loading change exists on the input lines because this current is essentially constant, independent of the state of the output.
2. The input signal voltages and the input common mode voltage should not be allowed to go negative by more than 0.3V. The positive limit of the common mode voltage range is  $V_+ - 1.5V$ , but either or both inputs can go to +32V without damage.
3.  $V_O = 1.4V_{DC}$ ,  $R_S = 0\Omega$  with  $V_+$  from 5V to 30V; and over the full input common mode voltage range (0V to  $V_+ - 1.5V$ ).
4. The maximum output current is approximately 40mA independent of the magnitude of  $V_+$ . Continuous short circuits at  $V_+ > 15V$  can cause excessive power dissipation and eventual destruction. Short circuits from the output to  $V_+$  can cause overheating and eventual destruction of the device. Destructive dissipation can result from simultaneous short circuits on both amplifiers.

**Electrical Specifications** Values Apply for Each Operational Amplifier, Supply Voltage (V+) = 5V, Unless Otherwise Specified

PARAMETERS	SYMBOL	TEST CONDITIONS	CA2904 LIMITS			UNITS
			MIN	TYP	MAX	
$T_A = +25^\circ C$						
Input Offset Voltage	$V_{IO}$	(Note 3)	-	2	7	mV
Output Voltage Swing	$V_{OPP}$	$R_L = 10k\Omega$	0	-	$V_+ - 1.5$	V
Input Common Mode Voltage Range	$V_{ICR}$	(Note 2), $V_+ = 30V$	0	-	$V_+ - 1.5$	V
Input Offset Current	$I_{IO}$	$I_{I+} - I_{I-}$	-	5	50	nA
Input Bias Current	$I_{IB}$	$I_{I+}$ or $I_{I-}$ , (Note 1)	-	45	250	nA
Output Current (Source)	$I_O$	$V_{I+} = +1V, V_{I-} = 0V, V_+ = 15V$	20	40	-	mA
Output Current (Sink)	$I_O$	$V_{I+} = 0V, V_{I-} = 1V, V_+ = 15V$	10	20	-	mA
Short Circuit Output Current		$R_L = 0\Omega$ (to Ground) (Note 4)	-	40	60	mA
Large Signal Voltage Gain	$A_{OL}$	$R_L \geq 2k\Omega, V_+ = 15V$ (For large $V_O$ swing)	-	100	-	V/mV
Common Mode Rejection Ratio	CMRR	DC	50	70	-	dB
Power Supply Rejection Ratio	PSRR	DC	50	100	-	dB
Amplifier-to-Amplifier Coupling		$f = 1$ to 20kHz (Input referred)	-	-120	-	dB
$T_A = -40^\circ C$ to $+85^\circ C$						
Input Offset Voltage	$V_{IO}$	(Note 3)	-	-	10	mV
Temperature Coefficient of Input Offset Voltage	$\propto V_{IO}$	$R_S = 0\Omega$	-	7	-	$\mu V/^\circ C$
Input Offset Current	$I_{IO}$	$I_{I+} - I_{I-}$	-	45	200	nA
Temperature Coefficient of Input Offset Current	$\propto I_{IO}$		-	10	-	$pA/^\circ C$
Input Bias Current	$I_{IB}$	$I_{I+}$ or $I_{I-}$	-	40	500	nA

**Electrical Specifications** Values Apply for Each Operational Amplifier, Supply Voltage (V+) = 5V, Unless Otherwise Specified (Continued)

PARAMETERS	SYMBOL	TEST CONDITIONS	CA2904 LIMITS			UNITS
			MIN	TYP	MAX	
Input Common Mode Voltage Range	$V_{ICR}$	$V_+ = 30V$ (Note 2)	0	-	$V_+ - 2$	V
Supply Current	$I_+$	$R_L = \infty$ On all amplifiers	-	0.7	1.2	mA
		$R_L = \infty, V_+ = 30V$	-	1.5	3	mA

NOTES:

1. Due to the p-n-p input stage the direction of the input current is out of the IC. No loading change exists on the input lines because this current is essentially constant, independent of the state of the output.
2. The input signal voltages and the input common mode voltage should not be allowed to go negative by more than 0.3V. The positive limit of the common mode voltage range is  $V_+ - 1.5V$ , but either or both inputs can go to +32V without damage.
3.  $V_O = 1.4V_{DC}$ ,  $R_S = 0\Omega$  with  $V_+$  from 5V to 30V; and over the full input common mode voltage range (0V to  $V_+ - 1.5V$ ).
4. The maximum output current is approximately 40mA independent of the magnitude of  $V_+$ . Continuous short circuits at  $V_+ > 15V$  can cause excessive power dissipation and eventual destruction. Short circuits from the output to  $V_+$  can cause overheating and eventual destruction of the device. Destructive dissipation can result from simultaneous short circuits on both amplifiers.

**Schematic Diagram**

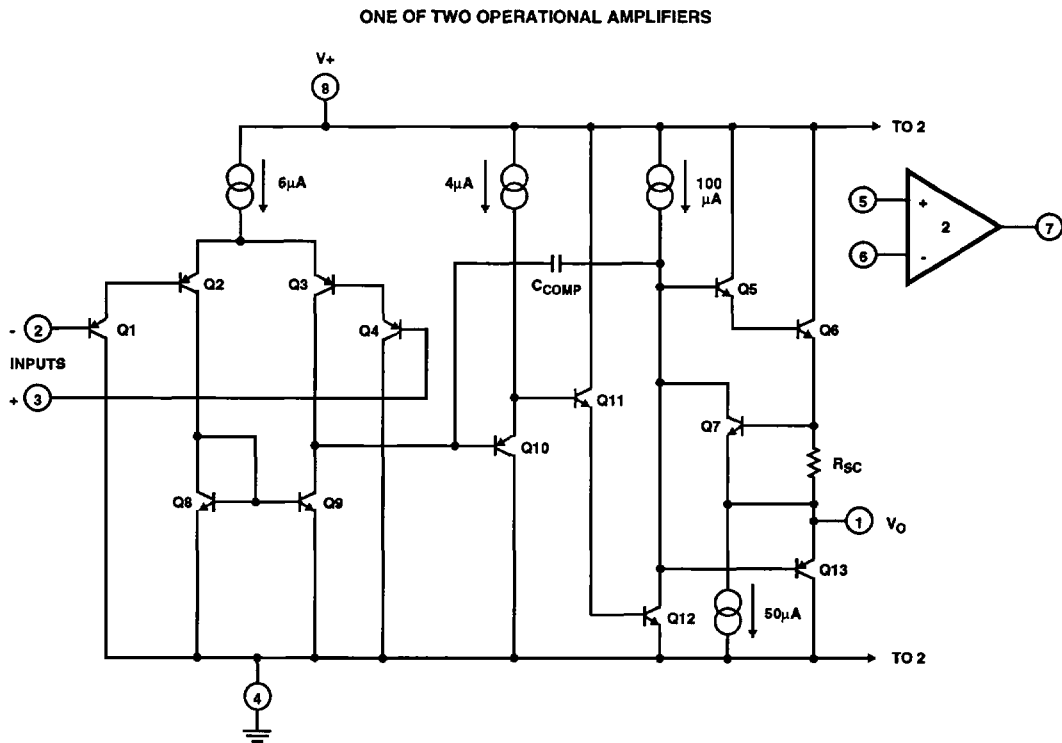



Typical Performance Curves

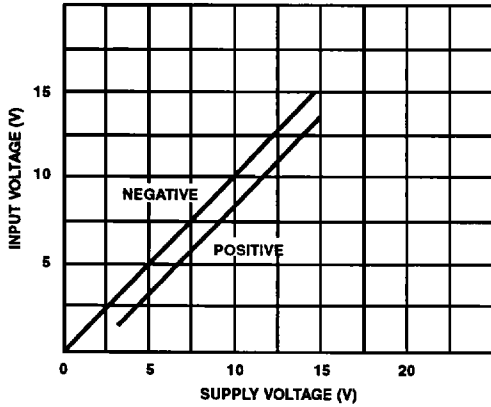

FIGURE 1. INPUT VOLTAGE RANGE vs SUPPLY VOLTAGE

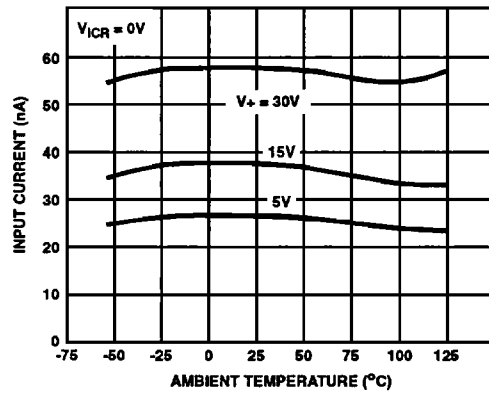

FIGURE 2. INPUT CURRENT vs AMBIENT TEMPERATURE

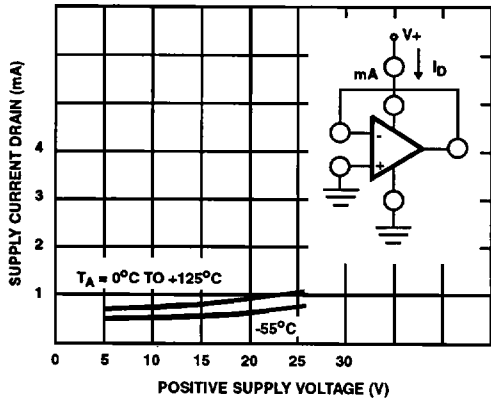

FIGURE 3. SUPPLY CURRENT DRAIN vs SUPPLY VOLTAGE

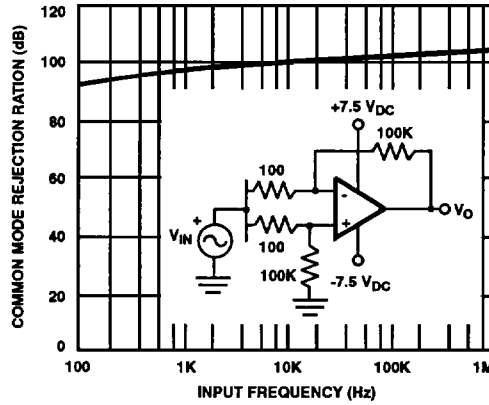

FIGURE 4. COMMON MODE REJECTION RATIO vs INPUT FREQUENCY

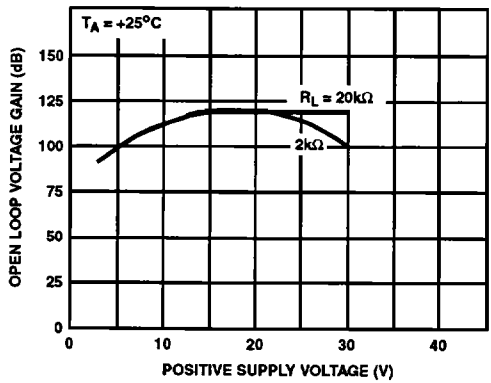

FIGURE 5. VOLTAGE GAIN vs SUPPLY VOLTAGE

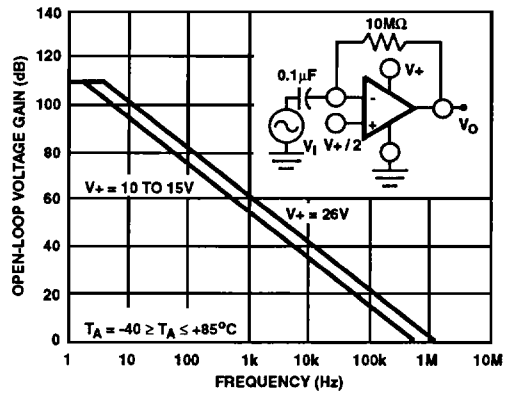

FIGURE 6. OPEN-LOOP FREQUENCY RESPONSE

Typical Performance Curves (Continued)

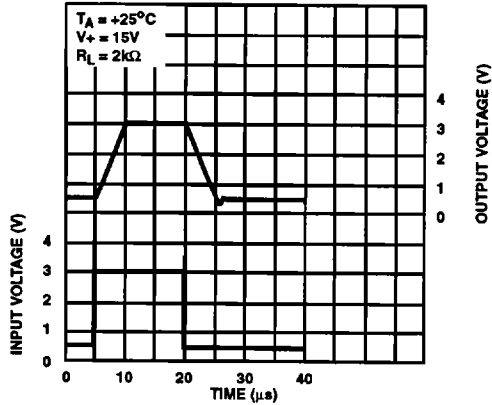

FIGURE 7. VOLTAGE FOLLOWER PULSE RESPONSE (LARGE SIGNAL)

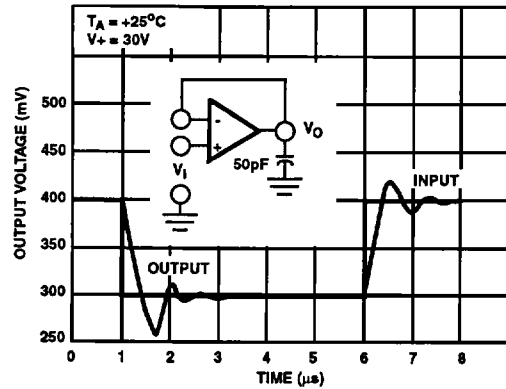

FIGURE 8. VOLTAGE FOLLOWER PULSE RESPONSE (SMALL SIGNAL)

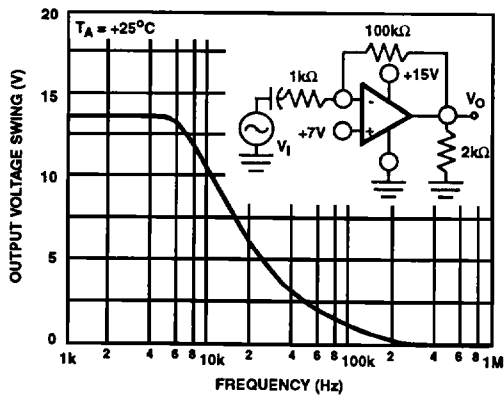

FIGURE 9. LARGE-SIGNAL FREQUENCY RESPONSE

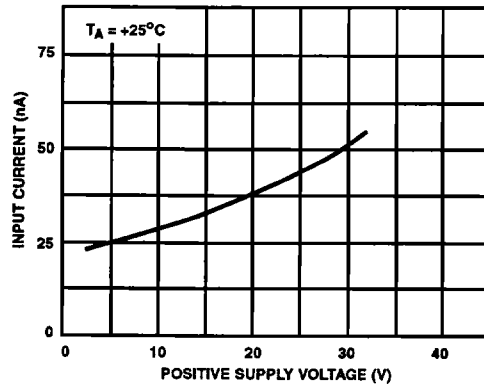

FIGURE 10. INPUT CURRENT vs SUPPLY VOLTAGE

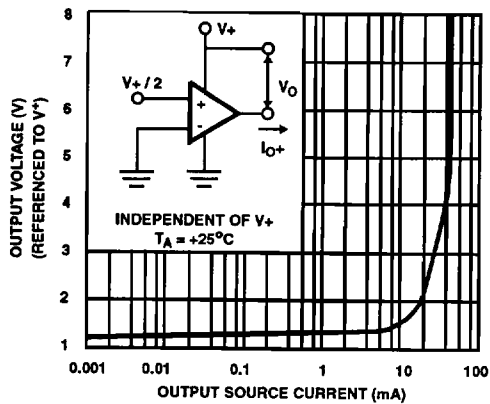

FIGURE 11. OUTPUT SOURCE CURRENT CHARACTERISTICS

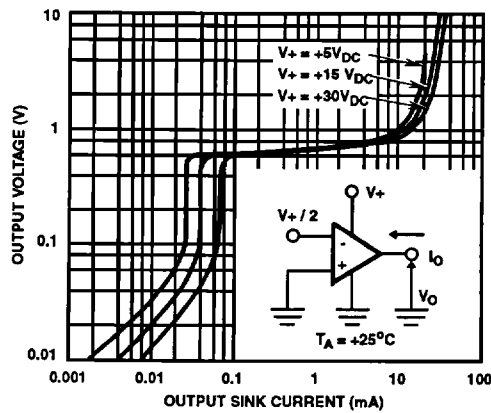

FIGURE 12. OUTPUT SINK CURRENT CHARACTERISTICS

Typical Performance Curves (Continued)

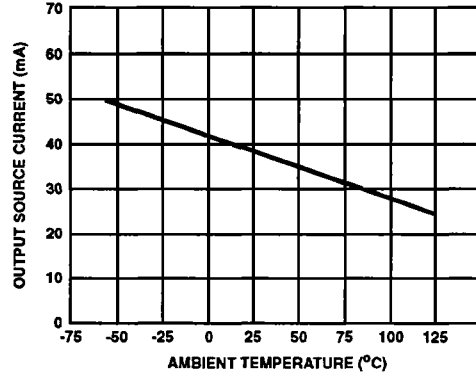
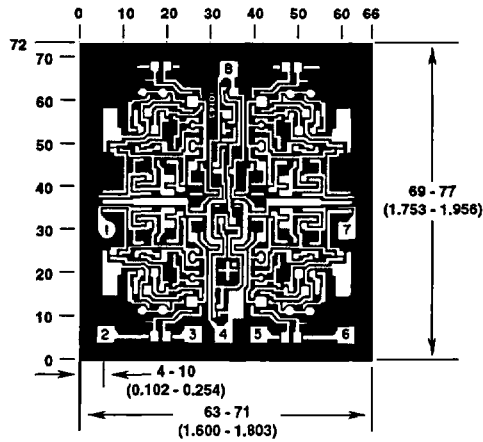

FIGURE 13. OUTPUT CURRENT vs AMBIENT TEMPERATURE

Metallization Mask Layout



Dimensions in parentheses are in millimeters and derived from the basic inch dimensions as indicated. Grid graduations are in mils ( $10^{-3}$  inch).

The photographs and dimensions represent a chip when it is part of the wafer. When the wafer is cut into chips, the cleavage angles are  $57^\circ$  instead of  $90^\circ$  with respect to the face of the chip. Therefore, the isolated chip is actually 7 mils (0.17mm) larger in both dimensions.