

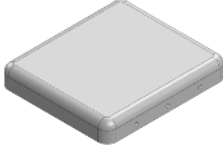

MS260-10*

DRAWN-SEAMLESS EMI/RFI SHIELD

*OPTIONAL SHIELD CONFIGURATIONS

			
2-PIECE SHIELD COVER	2-PIECE SHIELD COVER	2-PIECE SHIELD FRAME	1-PIECE SHIELD

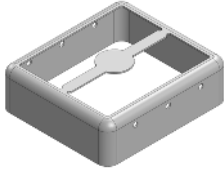
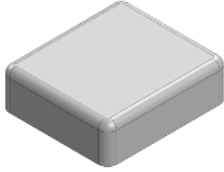
ITEM P/N	ITEM DESCRIPTION	MATERIAL
MS260-10C	2-PIECE EMI/RFI SHIELD COVER	TIN-PLATED STEEL
MS260-10CP	2-PIECE EMI/RFI SHIELD COVER (PERFORATED)	TIN-PLATED STEEL
MS260-10F	2-PIECE EMI/RFI SHIELD FRAME	TIN-PLATED STEEL
MS260-10S	1-PIECE EMI/RFI SHIELD	TIN-PLATED STEEL
MS260-10C-NS	2-PIECE EMI/RFI SHIELD COVER	NICKEL-SILVER
MS260-10CP-NS	2-PIECE EMI/RFI SHIELD COVER (PERFORATED)	NICKEL-SILVER
MS260-10F-NS	2-PIECE EMI/RFI SHIELD FRAME	NICKEL-SILVER
MS260-10S-NS	1-PIECE EMI/RFI SHIELD	NICKEL-SILVER

TIN-PLATED STEEL: CRS ELECTROLYTIC TINPLATE

NICKEL-SILVER: UNS C77000 / UNS C73500



SHIELD CONFIGURATION:

MATERIAL:

© MASACH TECH LTD.
 22 HAGANAN, MODIIN 7169513 ISRAEL
 T: (+972) 8-9754681 / F: (+972) 8-9754682
info@masach.com / www.masach.com

SHIELD TYPE:

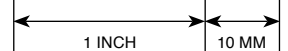



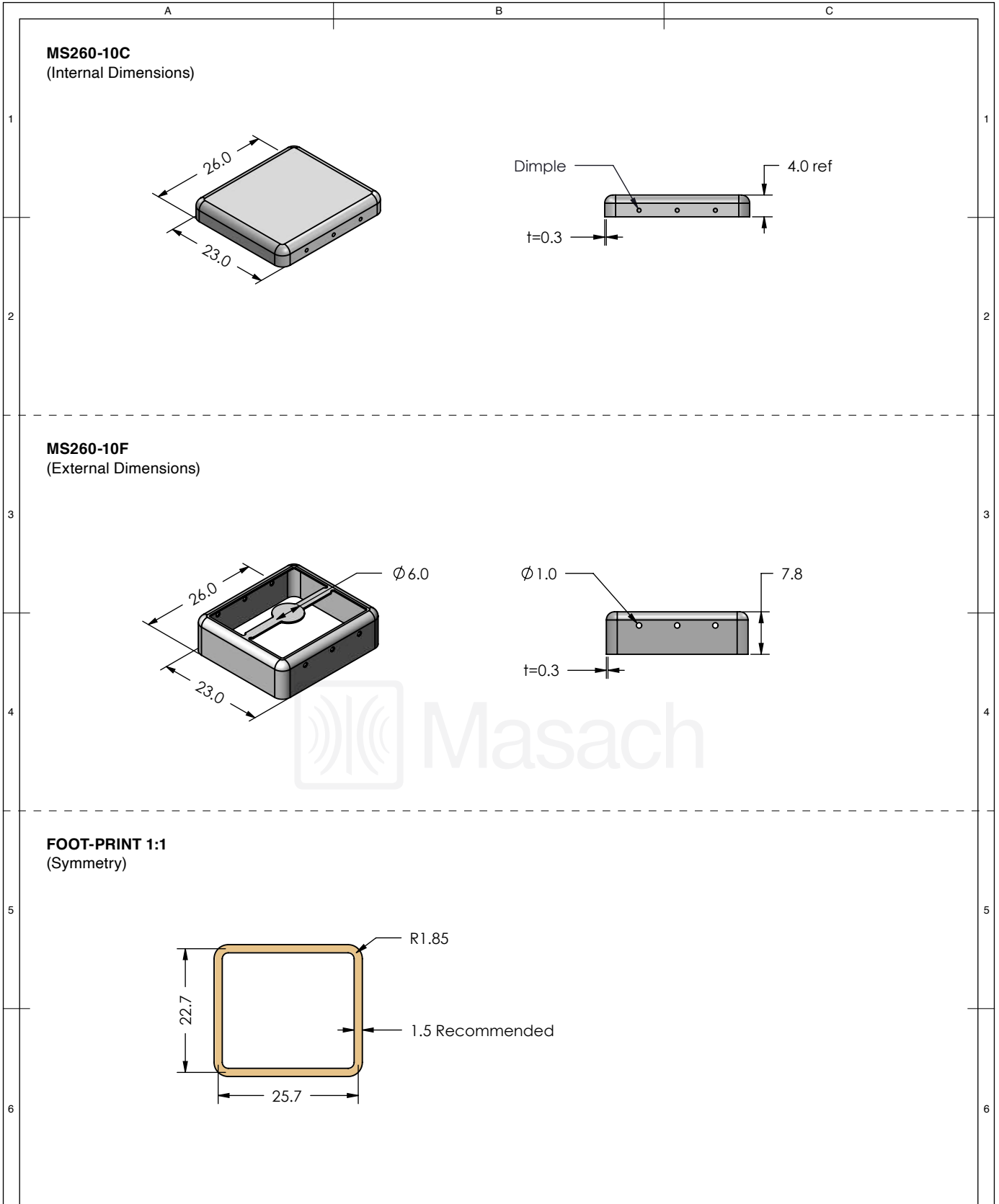

MMGS / PRINT 1:1 / A4

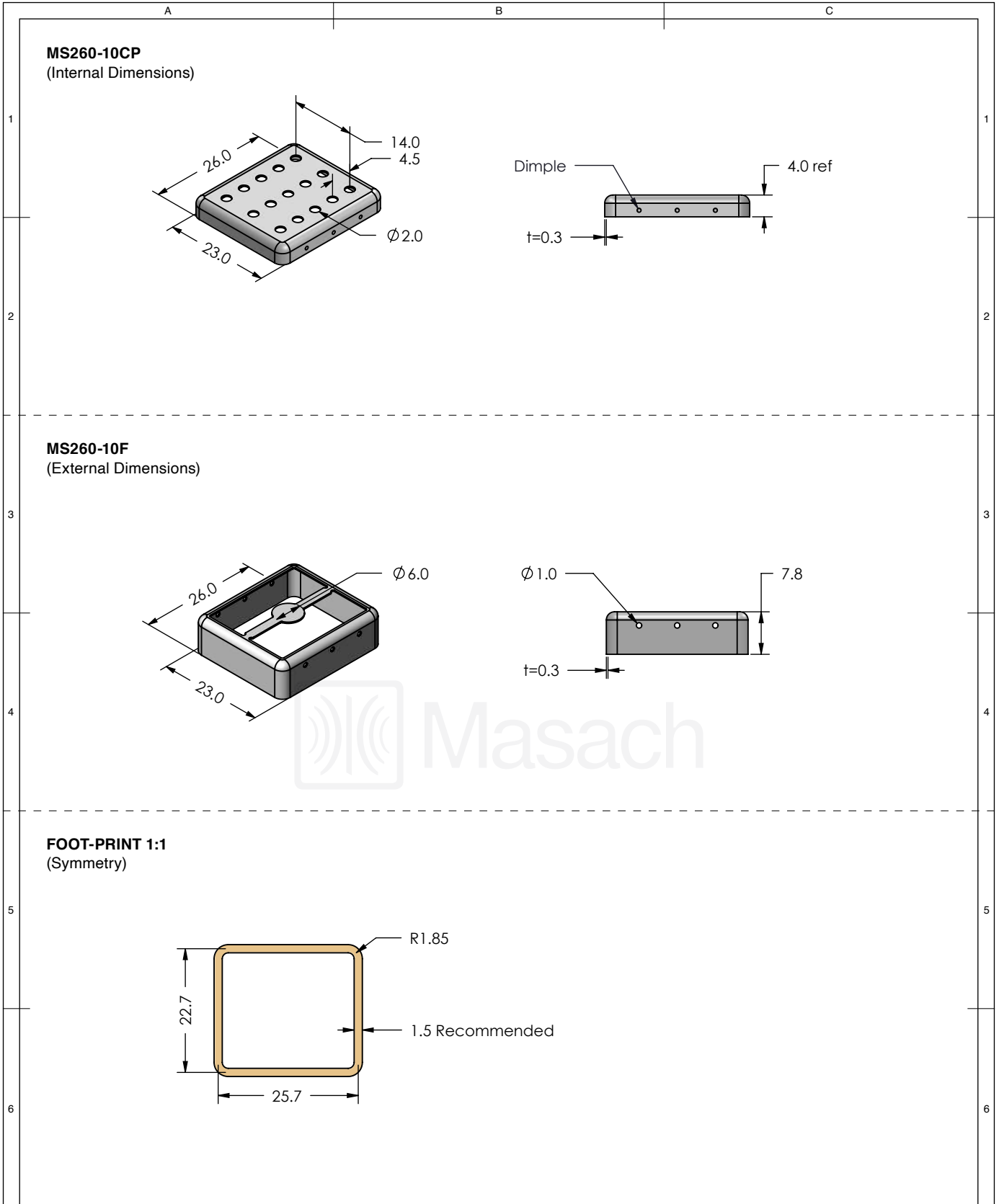

	SHIELD CONFIGURATION:		MATERIAL:	
	2-PIECE EM/RFI SHIELD		TIN-PLATED STEEL ⁽¹⁾	
	NOTE: (1) CRS ELECTROLYTIC TINPLATE (2) GENERAL TOLERANCE (+/-) 0.2MM			
© MASACH TECH LTD. 22 HAGANAN, MODIIN 7169513 ISRAEL T: (+972) 8-9754681 / F: (+972) 8-9754682 info@masach.com / www.masach.com	SHIELD TYPE:			
	DRAWN-SEAMLESS EM/RFI SHIELD			

This product has been designed and manufactured by © Masach Tech Ltd. The use of this product in any type of electronic device or application is not under Masach Tech Ltd. liability.

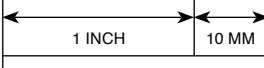

	SHIELD CONFIGURATION:		MATERIAL:	
	2-PIECE EM/RFI SHIELD		TIN-PLATED STEEL ⁽¹⁾	
	NOTE: (1) CRS ELECTROLYTIC TINPLATE (2) GENERAL TOLERANCE (+/-) 0.2MM			
© MASACH TECH LTD. 22 HAGANAN, MODIIN 7169513 ISRAEL T: (+972) 8-9754681 / F: (+972) 8-9754682 info@masach.com / www.masach.com	SHIELD TYPE:		 	
	DRAWN-SEAMLESS EM/RFI SHIELD			

This product has been designed and manufactured by © Masach Tech Ltd. The use of this product in any type of electronic device or application is not under Masach Tech Ltd. liability.

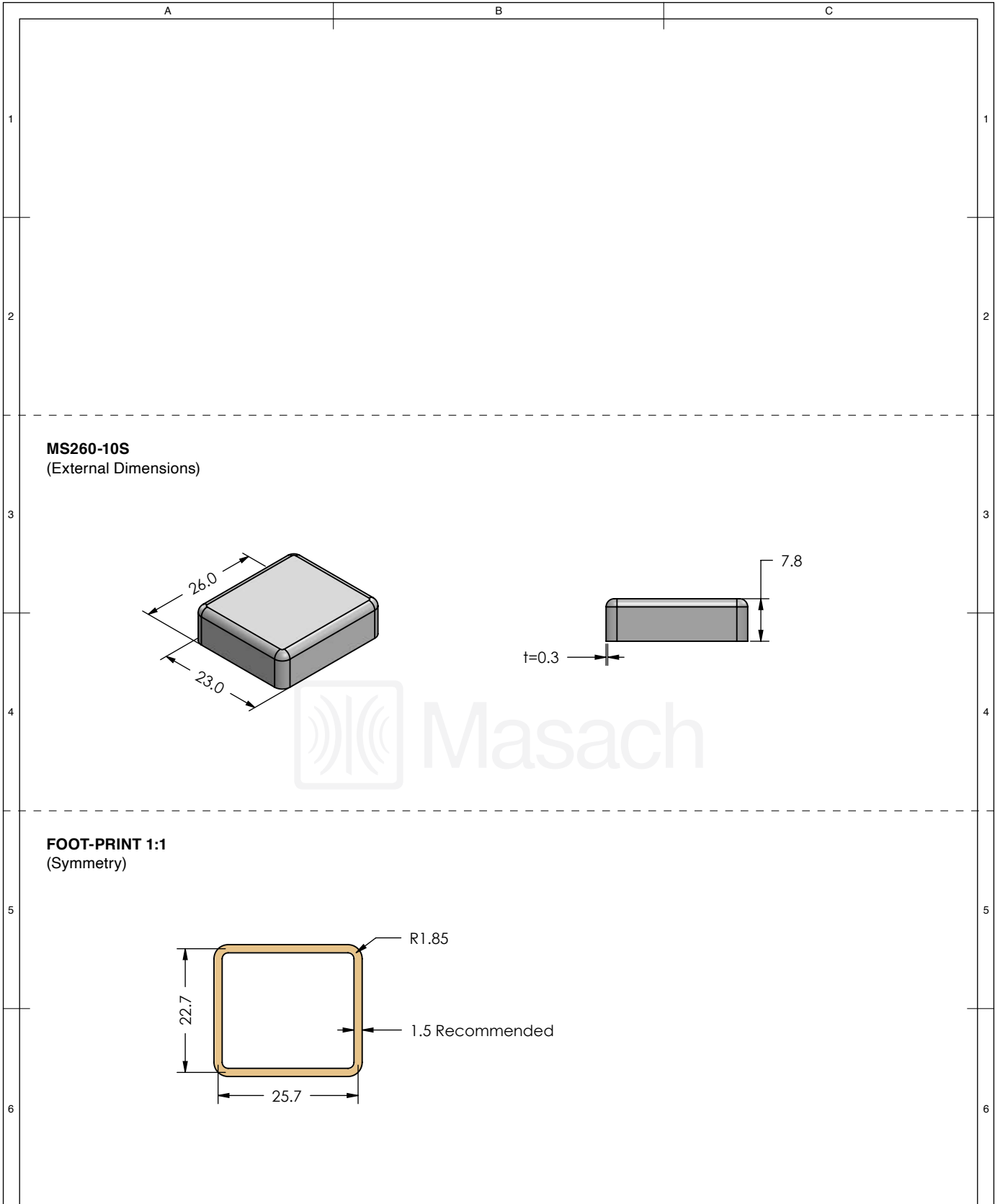

	SHIELD CONFIGURATION:	MATERIAL:
	1-PIECE EM/RFI SHIELD	TIN-PLATED STEEL ⁽¹⁾
NOTE: (1) CRS ELECTROLYTIC TINPLATE (2) GENERAL TOLERANCE (+/-) 0.2MM		
© MASACH TECH LTD. 22 HAGANAN, MODIIN 7169513 ISRAEL T: (+972) 8-9754681 / F: (+972) 8-9754682 info@masach.com / www.masach.com	SHIELD TYPE:	
	DRAWN-SEAMLESS EM/RFI SHIELD	
MMGS / PRINT 1:1 / A4		

This product has been designed and manufactured by © Masach Tech Ltd. The use of this product in any type of electronic device or application is not under Masach Tech Ltd. liability.

MS260-10C-NS
(Internal Dimensions)

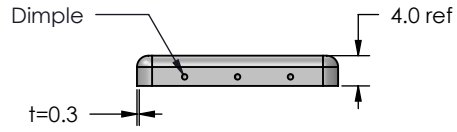
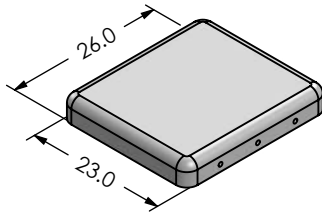

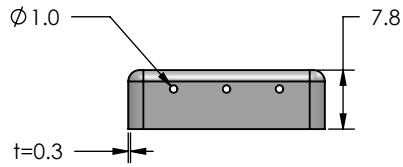
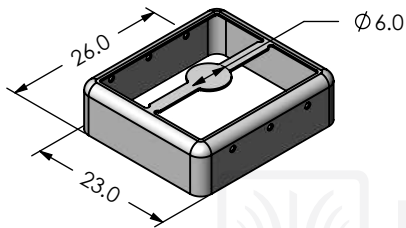

MS260-10F-NS
(External Dimensions)



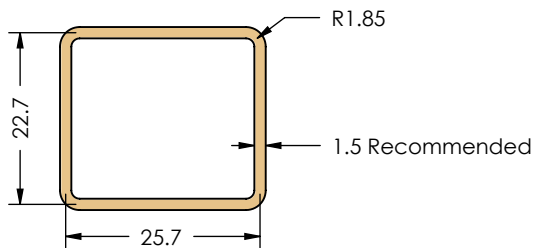

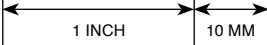

FOOT-PRINT 1:1
(Symmetry)

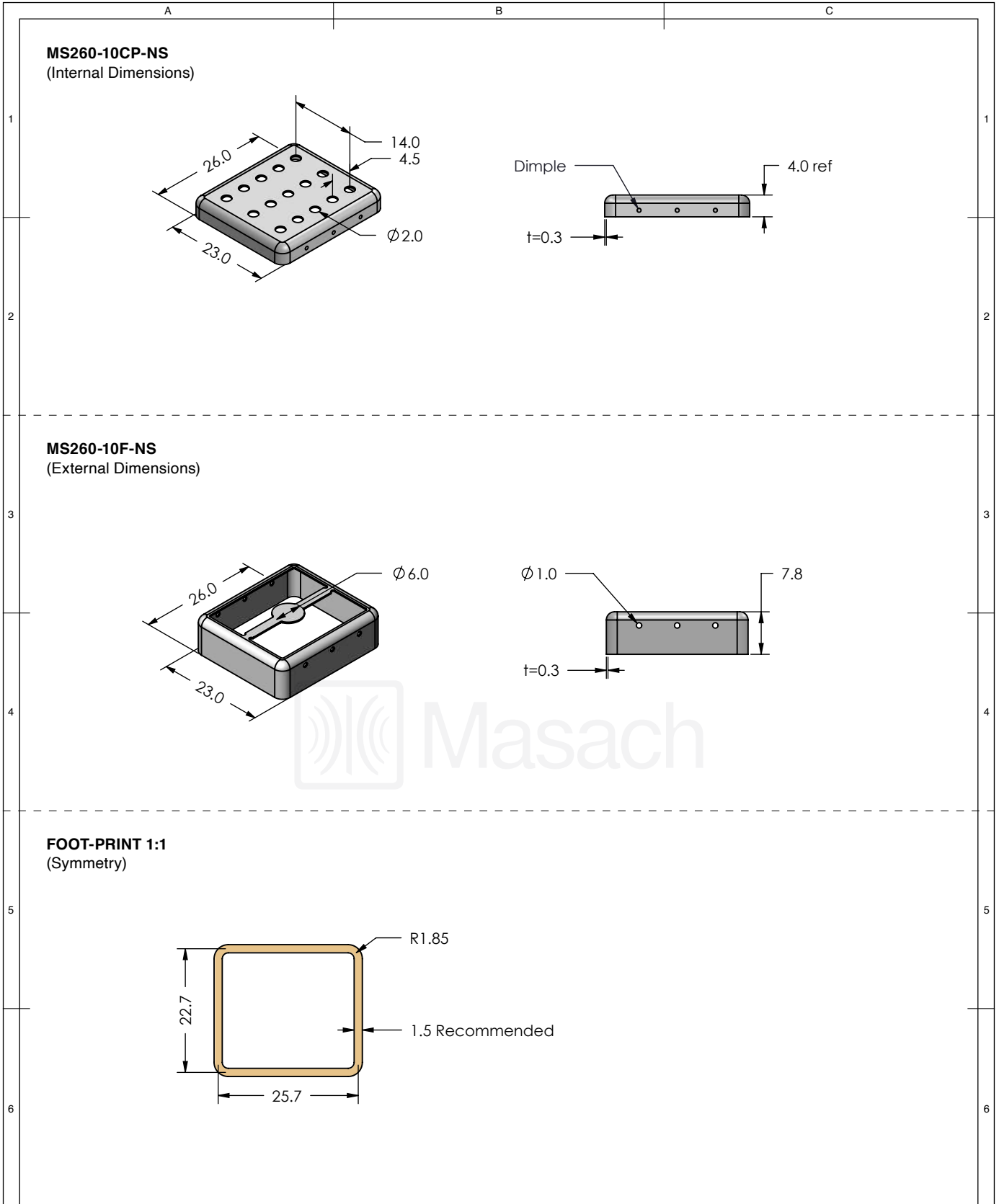

	SHIELD CONFIGURATION:		MATERIAL:	
	2-PIECE EM/RFI SHIELD		NICKEL-SILVER ⁽¹⁾	
	NOTE: (1) UNS C77000 / UNS C73500 (2) GENERAL TOLERANCE (+/-) 0.2MM			
© MASACH TECH LTD. 22 HAGANAN, MODIIN 7169513 ISRAEL T: (+972) 8-9754681 / F: (+972) 8-9754682 info@masach.com / www.masach.com	SHIELD TYPE:		 	
	DRAWN-SEAMLESS EM/RFI SHIELD			

This product has been designed and manufactured by © Masach Tech Ltd. The use of this product in any type of electronic device or application is not under Masach Tech Ltd. liability.

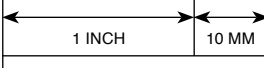

	SHIELD CONFIGURATION:		MATERIAL:	
	2-PIECE EM/RFI SHIELD		NICKEL-SILVER ⁽¹⁾	
	NOTE: (1) UNS C77000 / UNS C73500 (2) GENERAL TOLERANCE (+/-) 0.2MM			
© MASACH TECH LTD. 22 HAGANAN, MODIIN 7169513 ISRAEL T: (+972) 8-9754681 / F: (+972) 8-9754682 info@masach.com / www.masach.com	SHIELD TYPE:		 	
	DRAWN-SEAMLESS EM/RFI SHIELD			

This product has been designed and manufactured by © Masach Tech Ltd. The use of this product in any type of electronic device or application is not under Masach Tech Ltd. liability.

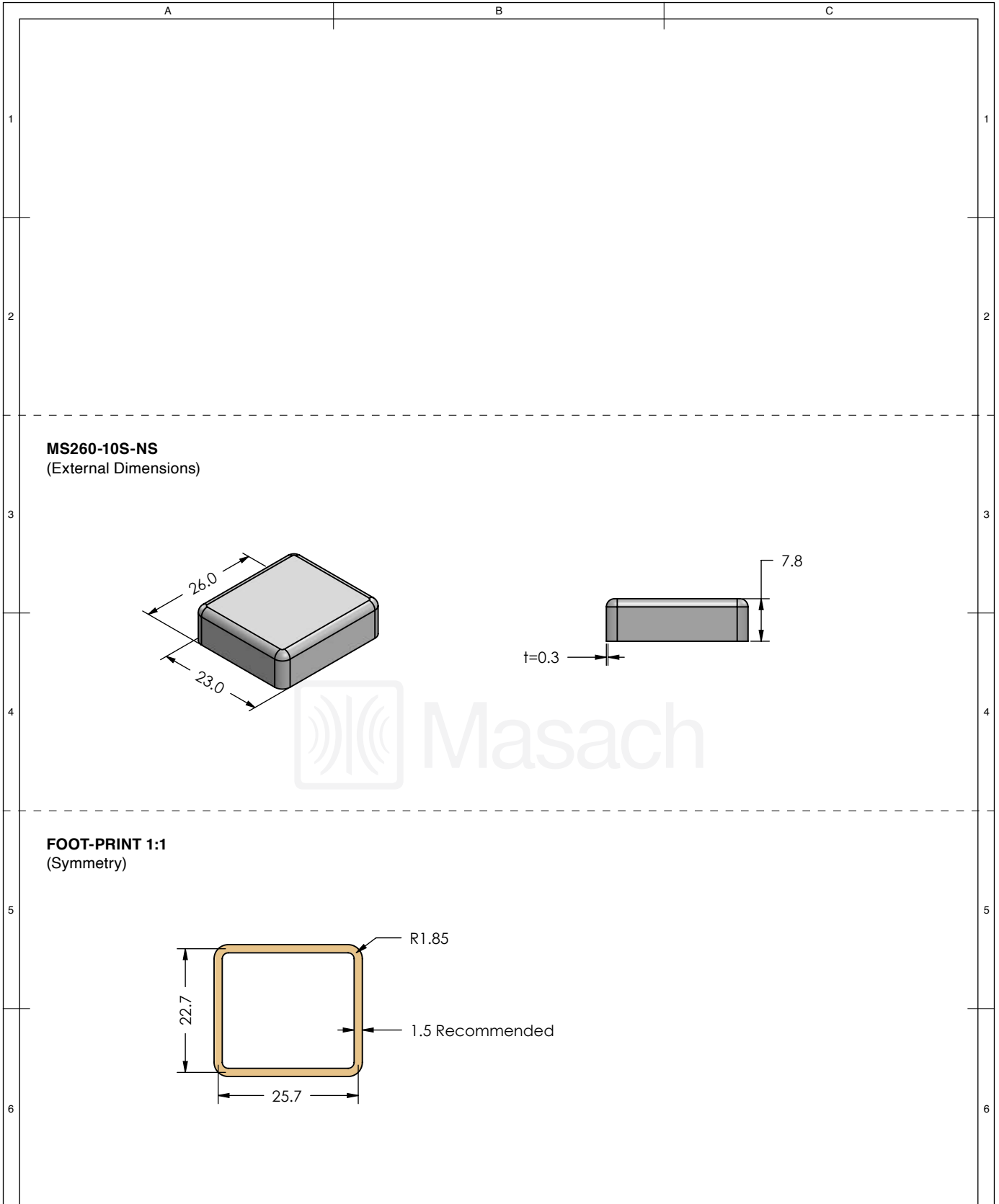

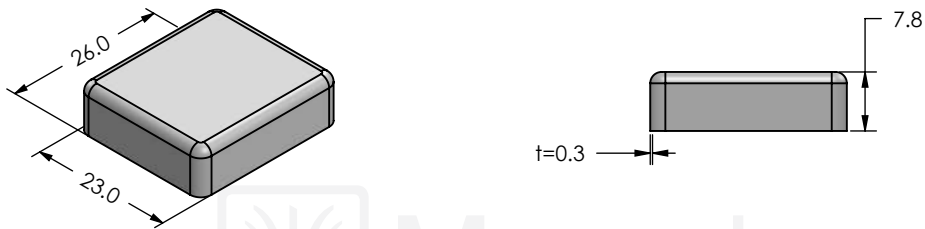

MS260-10S-NS
(External Dimensions)

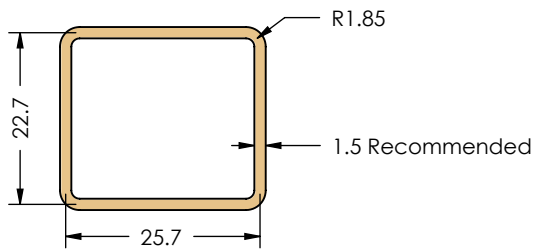

FOOT-PRINT 1:1
(Symmetry)

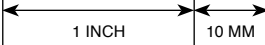

	SHIELD CONFIGURATION:		MATERIAL:	
	1-PIECE EM/RFI SHIELD		NICKEL-SILVER ⁽¹⁾	
	NOTE: (1) UNS C77000 / UNS C73500 (2) GENERAL TOLERANCE (+/-) 0.2MM			
© MASACH TECH LTD. 22 HAGANAN, MODIIN 7169513 ISRAEL T: (+972) 8-9754681 / F: (+972) 8-9754682 info@masach.com / www.masach.com	SHIELD TYPE:		 	
	DRAWN-SEAMLESS EM/RFI SHIELD			

This product has been designed and manufactured by © Masach Tech Ltd. The use of this product in any type of electronic device or application is not under Masach Tech Ltd. liability.

A



B

C

MS260-10* SMT/SMD PACKING TRAY

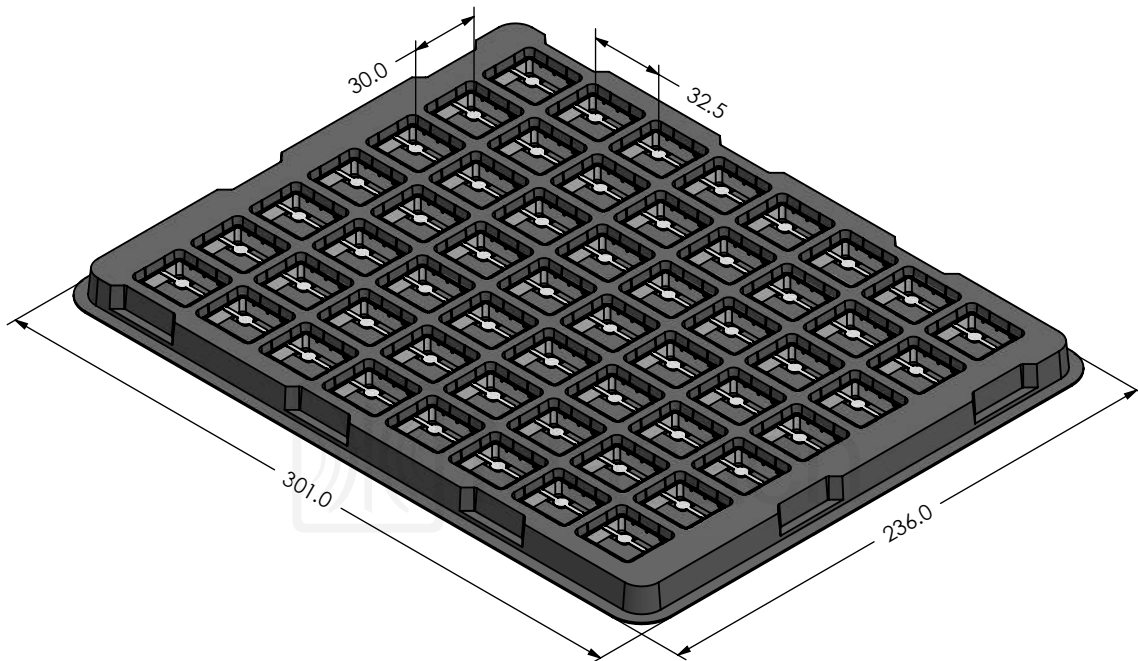
* COMPATIBLE TO ALL SHIELD CONFIGURATIONS

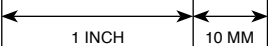

	SHIELD CONFIGURATION:		MATERIAL:	
<p>© MASACH TECH LTD. 22 HAGANAN, MODIIN 7169513 ISRAEL T: (+972) 8-9754681 / F: (+972) 8-9754682 info@masach.com / www.masach.com</p>	SHIELD TYPE:		 	
				MMGS / PRINT 1:1 / A4

This product has been designed and manufactured by © Masach Tech Ltd. The use of this product in any type of electronic device or application is not under Masach Tech Ltd. liability.