

Chip Ferrite Bead General Type

SIM02-33 Series

MERITEK

FEATURE

- Operating temperature: -55°C ~ +125°C (Including self-temperature rise)
- Storage temperature: -55°C ~ +125°C (on board)
- Monolithic Inorganic Material Construction
- Closed Magnetic Circuit Avoids Crosstalk
- Noise reduction solution for Signal Line
- Excellent Solderability and Heat Resistance



PART NUMBERING SYSTEM



SIM (1) 02 (2) 221 (3) Y (4) A20 (5) 33 (6)

No	item	Code	Description	
(1)	Product Code	SIM	Signal Chip Inductor, Multi-Layer Chip Ferrite Bead Type	
(2)	Dimension	02	02: 0402, 1.0x0.5mm	See Dimensions Table
(3)	Impedance	221	221: 220Ω	First two digit: Significant, Third: Multiplier
(4)	Tolerance	Y	Y: ±25%	Z: ±5Ω
(5)	Rated Current	A20	A20: 0.20A	A: Decimal
(6)	Series Code	33	Chip Ferrite Bead, General Type	Internal Control Code

DIMENSIONS

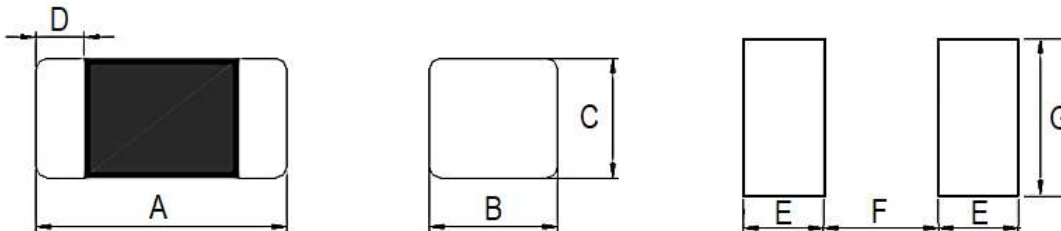

Size Code	A (mm)	B (mm)	C (mm)	D (mm)	E (mm)	F (mm)	G (mm)
SIM02 (0402)	1.00±0.10	0.50±0.10	0.50±0.10	0.25±0.10	0.50	0.40	0.60
SIM03 (0603)	1.6±0.15	0.80±0.15	0.80±0.15	0.30±0.20	0.80	0.85	0.95
SIM05 (0805)	2.00±0.20	1.25±0.20	0.85±0.20	0.50±0.30	1.05	1.00	1.45
SIM05 (0805)	2.00±0.20	1.25±0.20	1.25±0.20	0.50±0.30	1.05	1.00	1.45
SIM06 (1206)	3.20±0.20	1.60±0.20	1.10±0.20	0.50±0.30	1.05	2.20	1.80

Chip Ferrite Bead General Type

SIM02-33 Series

MERITEK

ELECTRICAL CHARACTERISTICS

Size	Part Number	Impedance (Ω)	Tolerance (%)	DCR (Ω) Max	Rated Current (mA) Max	Thickness (mm)
0402	SIM02300YA3033	30	$\pm 25\%$	0.20	300	0.50 \pm 0.10
	SIM02600YA3033	60	$\pm 25\%$	0.25	300	0.50 \pm 0.10
	SIM02121YA1033	120	$\pm 25\%$	0.30	100	0.50 \pm 0.10
	SIM02151YA1033	150	$\pm 25\%$	0.30	100	0.50 \pm 0.10
	SIM02221YA1033	220	$\pm 25\%$	0.40	100	0.50 \pm 0.10
	SIM02301YA1033	300	$\pm 25\%$	0.50	100	0.50 \pm 0.10
	SIM02471YA1033	470	$\pm 25\%$	0.65	100	0.50 \pm 0.10
	SIM02601YA0833	600	$\pm 25\%$	0.80	80	0.50 \pm 0.10
	SIM02102YA0533	1000	$\pm 25\%$	1.20	50	0.50 \pm 0.10
	SIM02600YA1033	60	$\pm 25\%$	0.30	100	0.50 \pm 0.10
	SIM02121YA0833	120	$\pm 25\%$	0.45	80	0.50 \pm 0.10
	SIM02221YA0533	220	$\pm 25\%$	0.60	50	0.50 \pm 0.10
	SIM02301YA0533	300	$\pm 25\%$	0.75	50	0.50 \pm 0.10

Notes: 1. Test Frequency: 100MHz; 2. Rated Current based on Temperature Rise Test

CHARACTERISTIC CURVES

SIM02300YA3033

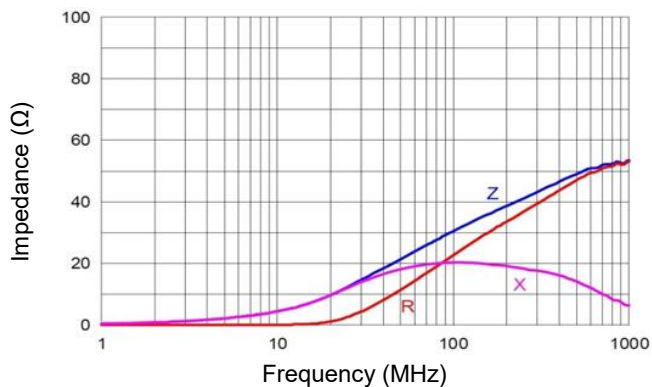

SIM02600YA3033

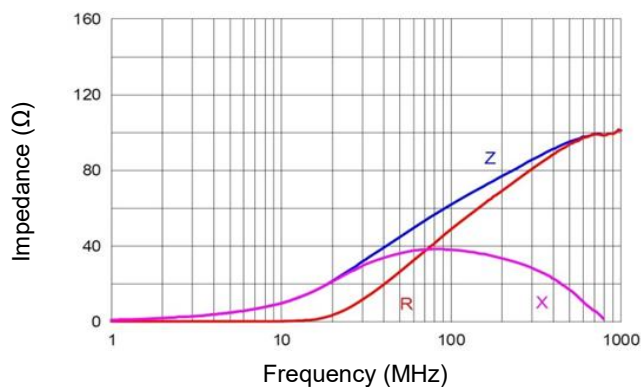

SIM02121YA1033

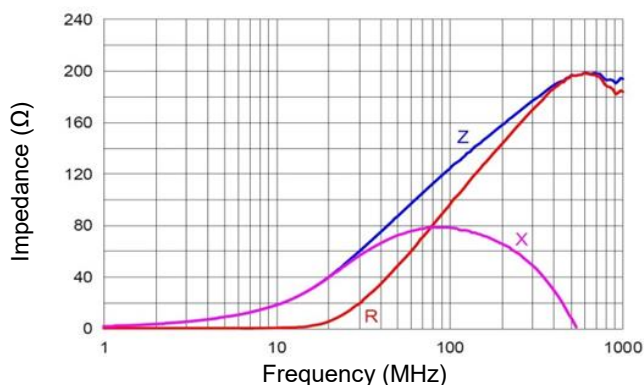

SIM02151YA1033

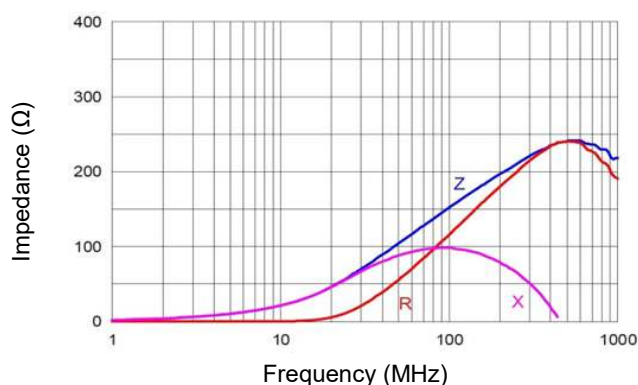

Chip Ferrite Bead General Type

SIM02-33 Series

MERITEK

CHARICTERISTIC CURVES

SIM02221YA1033

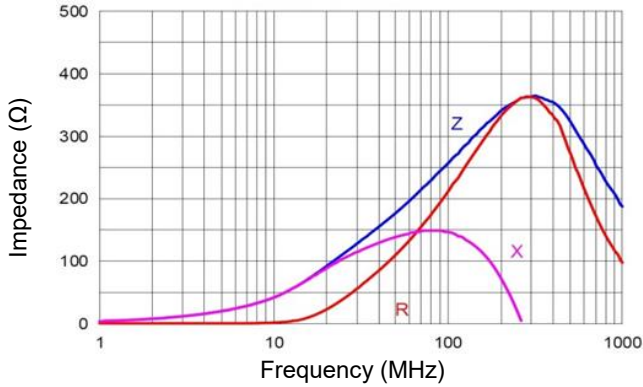

SIM02301YA1033

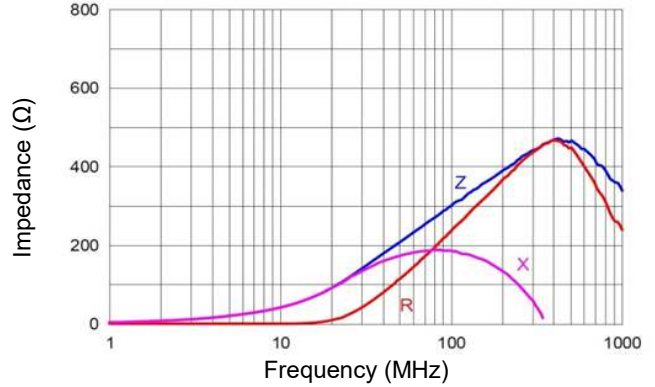

SIM02471YA1033

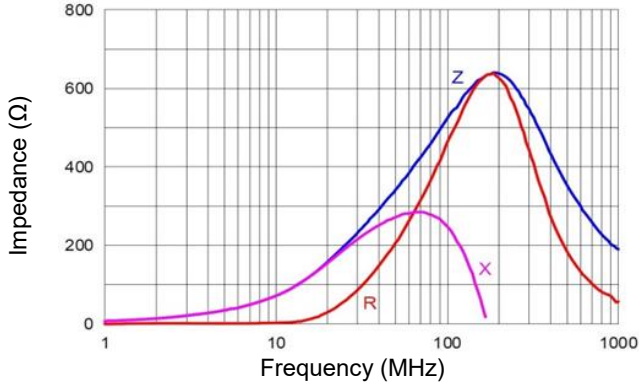

SIM02601YA0833

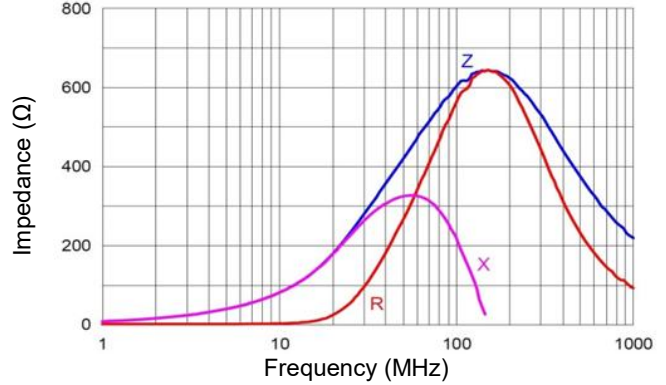

SIM02102YA0533

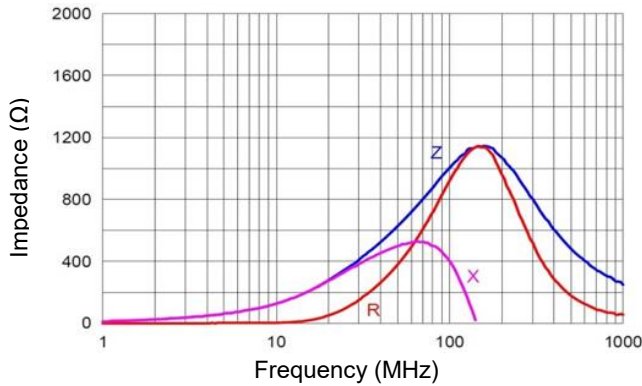

SIM02600YA1033

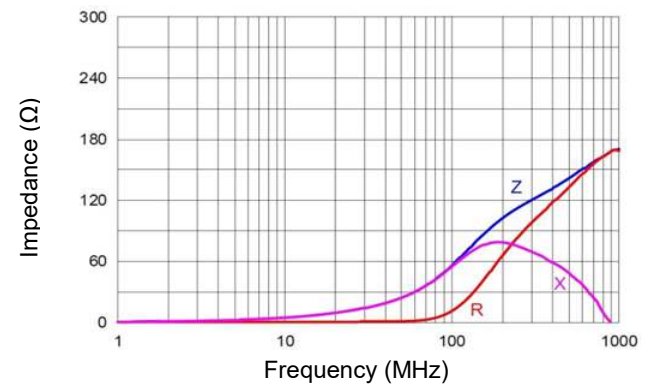

SIM02121YA0833

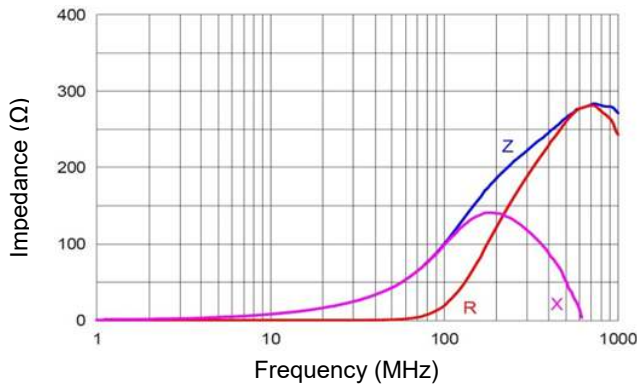

SIM02221YA0533

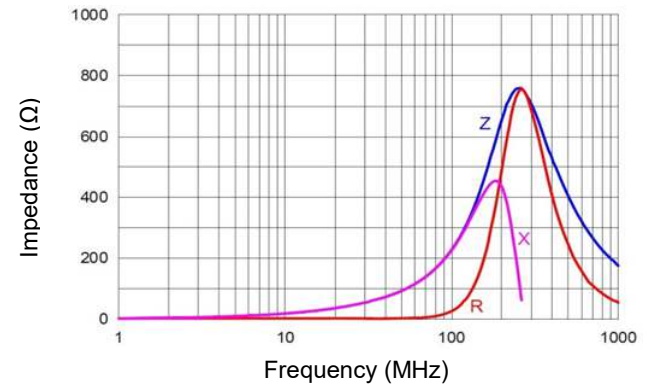

Chip Ferrite Bead General Type

SIM02-33 Series

MERITEK

CHARICTERISTIC CURVES

SIM02301YA0533

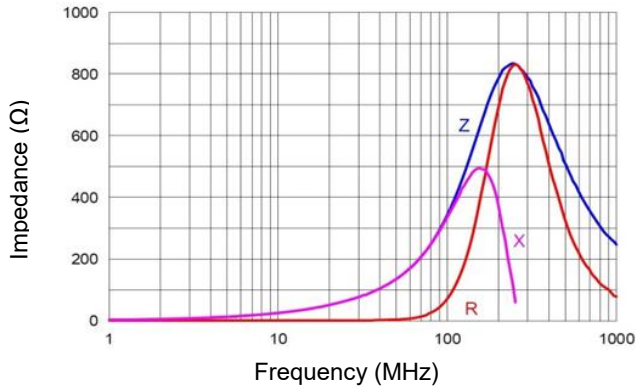

RECOMMENDED SOLDERING PROFILES

Reflow Condition		
Pre Heat	Temp. Min $T_{s(min)}$	150°C
	Temp. Max $T_{s(max)}$	200°C
	Time (min. to max.) (t_s)	60 ~180 seconds
Reflow	Temp. (T_L)	217°C
	Time (min. to max.) (t_L)	60 ~150 seconds
Peak Temperature (T_P)		260°C
Time within 5°C of actual peak Temperature (t_p)		10 seconds max.
Reflow times:		3 times Max.

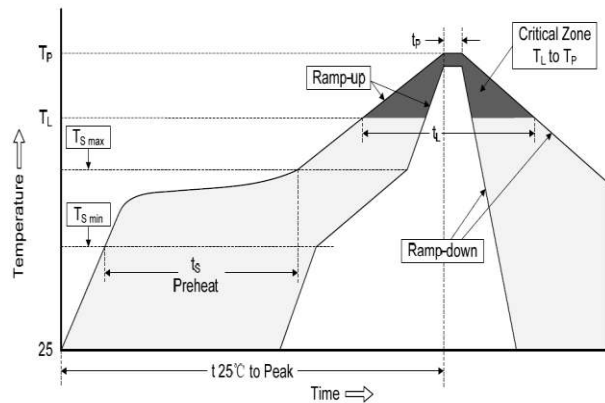

DERATING CURVE

Derating Curve

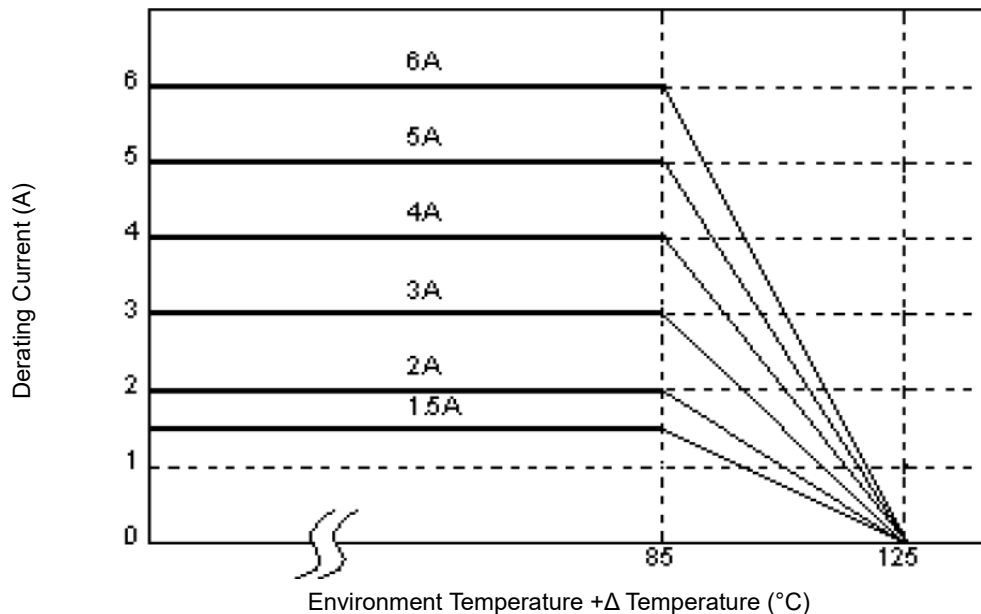

Chip Ferrite Bead General Type

SIM02-33 Series

MERITEK

RELIABILITY TEST CONDITON AND REQUIREMENT

Item	Test Conditions	Requirement															
Temperature Rise Test	Applied the allowed DC current. Temperature measured by digital surface thermometer.	Rated Current < 1A ΔT 20°CMax. Rated Current \geq 1A ΔT 40°CMax.															
Solderability	Method B, 4hrs @ 155°C dry heat @ 235 \pm 5°C Test time: 5 +0/-0.5 sec. Method D category 3. (steam aging 8hrs \pm 15min) @ 260 \pm 5°C Test time: 30 +0/-0.5sec.	More than 95% of the terminal electrode should be covered with solder.															
Resistance to Soldering Heat	Solder temperature: 260 \pm 5°C for 10 \pm 1 seconds; Temperature ramp/immersion and emersion rate: 25mm/s \pm 6 mm/s. Depth: Completely cover the termination.	Appearance: no damage. Impedance: within \pm 15%of initial value. Inductance: within \pm 10%of initial value.															
Vibration	Preconditioning: Run through IR reflow for 3 times. Oscillation Frequency: 10~2K~10 Hz for 20 minutes Equipment: Vibration checker, Total Amplitude:10g Testing Time: 12 hours (20 minutes, 12 cycles each of 3 orientations)	Appearance: no damage. Impedance: within \pm 15%of initial value. Inductance: within \pm 10%of initial value.															
Shock	Test condition: <table border="1" style="margin-left: 20px;"> <thead> <tr> <th>Type</th> <th>Peak Value (g's)</th> <th>Normal duration (ms)</th> <th>Wave From</th> <th>Velocity change (ft/sec)</th> </tr> </thead> <tbody> <tr> <td>SMD</td> <td>50</td> <td>11</td> <td>Half-sine</td> <td>11.3</td> </tr> <tr> <td>Lead</td> <td>50</td> <td>11</td> <td>Half-sine</td> <td>11.3</td> </tr> </tbody> </table>	Type	Peak Value (g's)	Normal duration (ms)	Wave From	Velocity change (ft/sec)	SMD	50	11	Half-sine	11.3	Lead	50	11	Half-sine	11.3	Appearance: no damage. Impedance: within \pm 10%of initial value. Inductance: within \pm 10%of initial value.
Type	Peak Value (g's)	Normal duration (ms)	Wave From	Velocity change (ft/sec)													
SMD	50	11	Half-sine	11.3													
Lead	50	11	Half-sine	11.3													
Terminal strength	Preconditioning: Run through IR reflow for 3 times. With component mounted on a PCB apply a force >0805:1kg, <=0805:0.5kg to the side of a device being tested. This force shall be applied for 60 +1 seconds. Also, the force shall be applied gradually as not to shock the component being tested.	Appearance: no damage. Impedance: within \pm 15%of initial value. Inductance: within \pm 10%of initial value.															
Thermal Shock	Preconditioning: Run through IR reflow for 3 times. Number of cycles: 500. Condition for 1 cycle: <table border="1" style="margin-left: 20px;"> <thead> <tr> <th>No.</th> <th>Temp. (°C)</th> <th>Time (min.)</th> </tr> </thead> <tbody> <tr> <td>1</td> <td>-55\pm2°C</td> <td>30\pm5</td> </tr> <tr> <td>2</td> <td>125\pm2°C</td> <td>\leq30 seconds</td> </tr> <tr> <td>3</td> <td>+125\pm2°C</td> <td>30\pm5</td> </tr> </tbody> </table> <p>Measured at room temperature after placing for 24\pm2 hrs.</p>	No.	Temp. (°C)	Time (min.)	1	-55 \pm 2°C	30 \pm 5	2	125 \pm 2°C	\leq 30 seconds	3	+125 \pm 2°C	30 \pm 5	Appearance: no damage. Impedance: within \pm 15%of initial value. Inductance: within \pm 10%of initial value.			
No.	Temp. (°C)	Time (min.)															
1	-55 \pm 2°C	30 \pm 5															
2	125 \pm 2°C	\leq 30 seconds															
3	+125 \pm 2°C	30 \pm 5															
Bending	Shall be mounted on a FR4 substrate of the following dimensions: <table border="1" style="margin-left: 20px;"> <thead> <tr> <th>Dimensions</th> <th>Bending depth</th> </tr> </thead> <tbody> <tr> <td>>=0805:40x100x1.2mm</td> <td>1.2mm</td> </tr> <tr> <td><0805:40x100x0.8mm</td> <td>0.8mm</td> </tr> </tbody> </table> <p>Duration of 10 sec for a min.</p>	Dimensions	Bending depth	>=0805:40x100x1.2mm	1.2mm	<0805:40x100x0.8mm	0.8mm	Appearance: no damage. Impedance: within \pm 10%of initial value. Inductance: within \pm 10%of initial value.									
Dimensions	Bending depth																
>=0805:40x100x1.2mm	1.2mm																
<0805:40x100x0.8mm	0.8mm																
Load Humidity	Preconditioning: Run through IR reflow for 3 times. Humidity: 85 \pm 2%R.H. Temperature: 85 \pm 2°C. Duration: 1000hrs Min. with 100% rated current. Measured at room temperature after 24 \pm 2 hrs.	Appearance: no damage. Impedance: within \pm 15%of initial value. Inductance: within \pm 10%of initial value.															
Life Test	Preconditioning: Run through IR reflow for 3 times. Temperature: 125 \pm 2°C Applied current: rated current. Duration: 1000 \pm 12 Hrs. Measured at room temperature after 24 \pm 2 Hrs.	Appearance: no damage. Impedance: within \pm 15%of initial value. Inductance: within \pm 10%of initial value.															

Chip Ferrite Bead General Type

SIM02-33 Series

MERITEK

PACKAGING SPECIFICATIONS

Reel Specification & Packaging Quantity

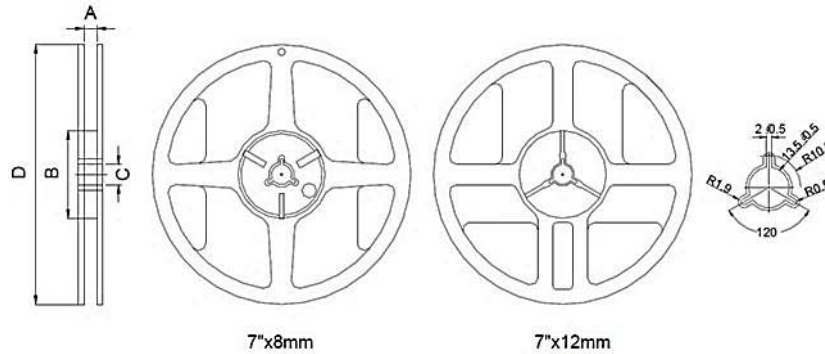

Size	Reel Dimension (mm)						
	Quantity	Tape Width	Reel Diameter	A	B	C	D
0402	Paper 10K	8mm	7"	9.0±0.5	60.0±2.0	13.5±0.5	178.0±2.0
0603	Paper 4K	8mm	7"	9.0±0.5	60.0±2.0	13.5±0.5	178.0±2.0
0805	Paper 4K	8mm	7"	9.0±0.5	60.0±2.0	13.5±0.5	178.0±2.0
0805	Plastic 2K	8mm	7"	9.0±0.5	60.0±2.0	13.5±0.5	178.0±2.0
1206	Plastic 3K	8mm	7"	9.0±0.5	60.0±2.0	13.5±0.5	178.0±2.0

PACKAGING SPECIFICATIONS

Paper Tape Specification

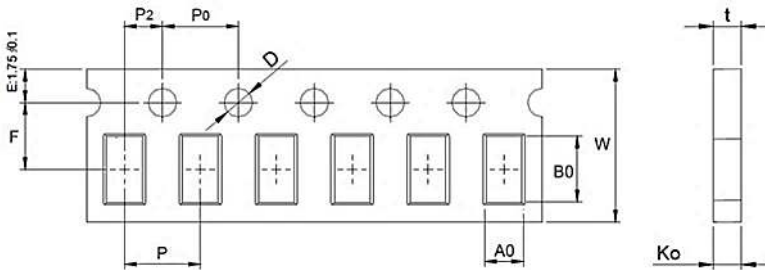

Plastic Tape Specification

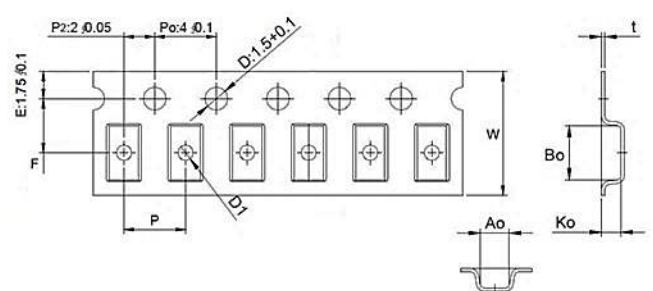

Size	Paper Tape Dimension (mm)									
	A0	B0	W	F	P ₀	P	P ₂	D	t	Ko
0402	0.62±0.03	1.12±0.03	8±0.3	3.5±0.05	4±0.1	2±0.05	-	1.5±0.1	0.6±0.03	0.6±0.03
0603	0.96+0.05/-0.03	1.80±0.05	8±0.1	3.5±0.1	4±0.1	4±0.1	2±0.1	1.56+0.1/-0.05	0.95±0.05	0.95±0.05
0805	1.3±0.05	2.1±0.05	8±0.1	3.5±0.1	4±0.1	4±0.1	2±0.1	1.56+0.1/-0.05	0.95±0.05	0.95±0.05
Size	Plastic Tape Dimension (mm)									
	A0	B0	W	F	P	P ₀	P ₂	D1	t	Ko
0805	1.28±0.1	2.1±0.1	8±0.1	3.5±0.05	4±0.1	4±0.1	2±0.05	1±0.1	0.22±0.05	1.28±0.1
1206	1.75±0.1	3.35±0.1	8±0.1	3.5±0.05	4±0.1	4±0.1	2±0.05	1±0.1	0.23±0.05	1.25±0.1

Notes: 0805 for plastic tape, has a thickness of 1.25mm

*Specifications subject to change without notice.