



Bridgelux® EB Series™ Gen 3 F90

Product Data Sheet DS13x

Lengths: 140mm, 280mm, 560mm, 1120mm

CRI: 90

CCTs: 2700K, 3000K, 3500K, 4000K, 5000K



Product Feature Map

Bridgelux EB Series Gen 3 modules are fully engineered devices that provide consistent thermal and optical performance on an engineered mechanical platform. The linear products incorporate several features to simplify design integration and assembly. Please visit www.bridgelux.com for more information on the EB Series family of products.

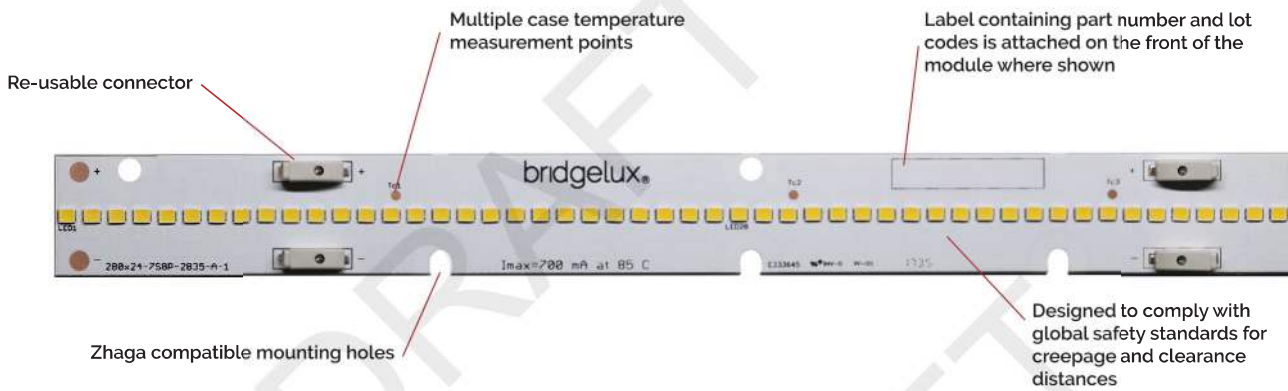

Product Nomenclature

The part number designation for Bridgelux EB Series Gen 3 F90 is explained as follows:

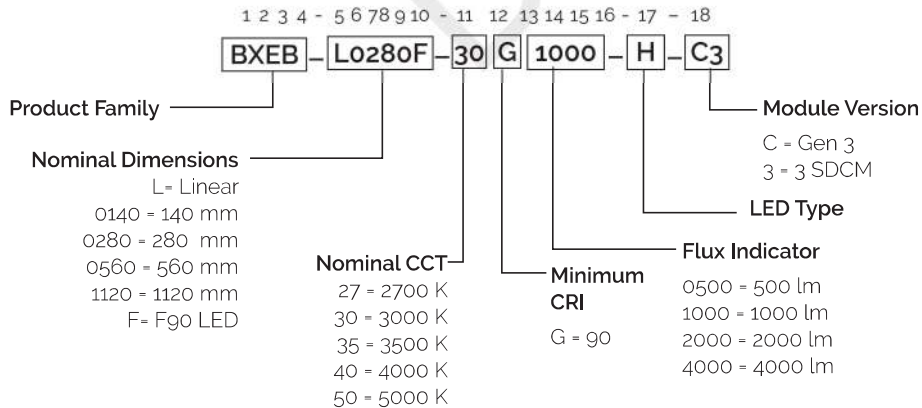

Product Selection Guide

Table 1: Product Performance ($T_c = 45^\circ \text{C}$)

Part Number	Nominal CCT ¹ (K)	CRI	Typical Flux ^{2,3} $T_c = 45^\circ \text{C}$ (lm)	Nominal Drive Current (mA)	Typical V_f (V)	Typical Power (W)	Typical Efficacy (lm/W)
BXEB-L0140F-27G0500-H-C3	2700	90	552	77	38.1	2.9	188
BXEB-L0140F-30G0500-H-C3	3000	90	560				191
BXEB-L0140F-35G0500-H-C3	3500	90	563				192
BXEB-L0140F-40G0500-H-C3	4000	90	574				196
BXEB-L0140F-50G0500-H-C3	5000	90	574				196
BXEB-L0280F-27G1000-H-C3	2700	90	1102	154		5.9	188
BXEB-L0280F-30G1000-H-C3	3000	90	1119				191
BXEB-L0280F-35G1000-H-C3	3500	90	1125				192
BXEB-L0280F-40G1000-H-C3	4000	90	1149				196
BXEB-L0280F-50G1000-H-C3	5000	90	1149				196
BXEB-L0560F-27G2000-H-C3	2700	90	2205	308		11.7	188
BXEB-L0560F-30G2000-H-C3	3000	90	2240				191
BXEB-L0560F-35G2000-H-C3	3500	90	2252				192
BXEB-L0560F-40G2000-H-C3	4000	90	2299				196
BXEB-L0560F-50G2000-H-C3	5000	90	2299				196
BXEB-L1120F-27G4000-H-C3	2700	90	4410	616	23.5	188	
BXEB-L1120F-30G4000-H-C3	3000	90	4481			191	
BXEB-L1120F-35G4000-H-C3	3500	90	4504			192	
BXEB-L1120F-40G4000-H-C3	4000	90	4598			196	
BXEB-L1120F-50G4000-H-C3	5000	90	4598			196	

Notes for Table 1:

1. Nominal CCT as defined by ANSI C78.377-2011.
2. Data is at nominal test current where temperature of center case temperature point $T_c = 45^\circ \text{C}$.
3. Bridgelux maintains a $\pm 7\%$ tolerance on flux data.

Electrical Characteristics

Table 2: Electrical Characteristics

Part Number	Drive Current (mA)	Forward Voltage $T_{c2} = 45^{\circ} \text{C (V)}^{1, 2, 3}$		
		Minimum	Typical	Maximum
BXEB-L0140F-xxx0500-H-C3	77	37.6	38.1	38.6
BXEB-L0280F-xxx1000-H-C3	154	37.6	38.1	38.6
BXEB-L0560F-xxx2000-H-C3	308	37.6	38.1	38.6
BXEB-L1120F-xxx4000-H-C3	616	37.6	38.1	38.6

Notes for Table 2:

1. Voltage minimum and maximum are provided for reference only and are not a guarantee of performance.
2. Bridgelux maintains a tolerance of $\pm 0.1 \text{ V}$ on forward voltage data.
3. This product has been designed and manufactured per IEC 62031:2014. The working voltage designated for the insulation is 60 V d.c. The maximum allowable voltage across the module must be determined in the end product application.
4. Typical coefficient of forward voltage tolerance is $\pm 0.1 \text{ mV}$ for nominal current.
5. V_f min hot and max cold values are provided as reference only and are not guaranteed. These values are provided to aid in driver design and selection over the operating range of the product.

Absolute Maximum Ratings

Table 3: Maximum Ratings

Parameter	Maximum Rating			
Storage Temperature	-40°C to +85°C			
Operating Case Temperature ² (T _c)	85°C			
Soldering Temperature	350°C or lower for a maximum of 5 seconds			
Maximum Reverse Voltage	Modules are not designed to be driven in reverse bias			
	BXEB-L0140F-xxx0500-H-C3	BXEB-L0280F-xxx1000-H-C3	BXEB-L0560F-xxx2000-H-C3	BXEB-L1140F-xxx4000-H-C3
Maximum Drive Current	154mA	308mA	616mA	1232mA

Notes for Table 3:

1. For IEC 62717 requirement, please consult your Bridgelux sales representative.
2. Lumen maintenance (L70) and lifetime predictions are valid for drive current and case temperature conditions used for LM-80 testing as included in the applicable LM-80 test report for the SMDs used in the modules. Contact your Bridgelux sales representatives for LM-80 report.

Typical Radiation Pattern

Figure 9: Typical Spatial Radiation Pattern



Notes for Figure 9:

- 1. Typical viewing angle is 120°.
- 2. The viewing angle is defined as the off axis angle from the centerline where I_v is $\frac{1}{2}$ of the peak value.

Typical Color Spectrum

Figure 11: Typical Color Spectra, 90 CRI

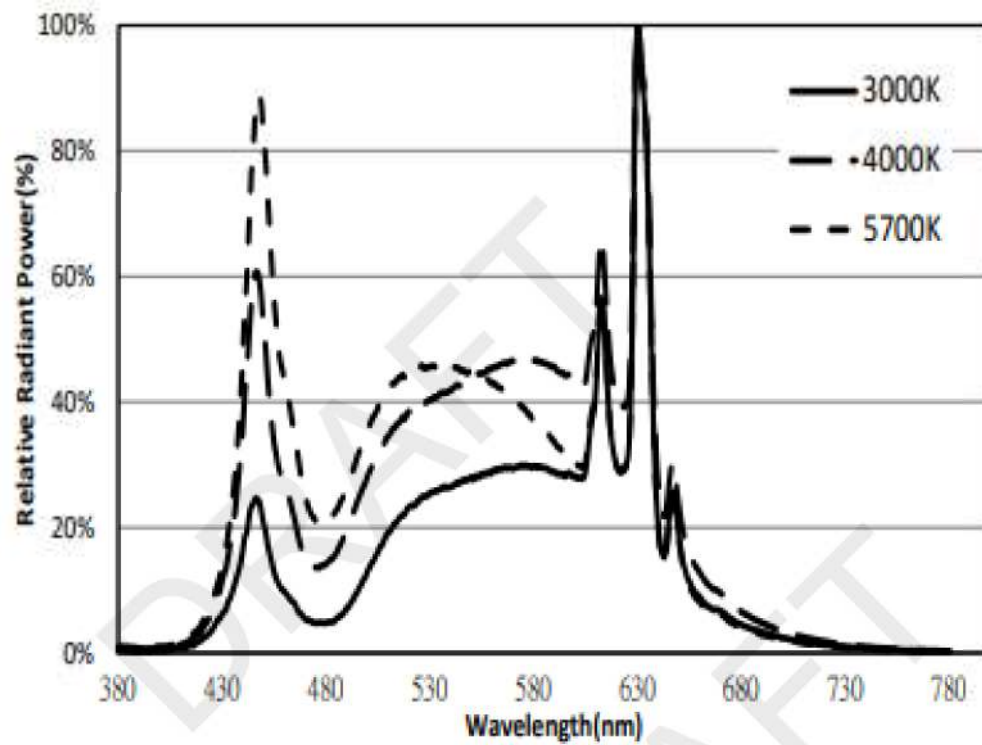

Note for Figures 10 & 11:

1. Color spectra measured at nominal current for $T_c = 85^\circ\text{C}$

Mechanical Dimensions

Figure 12: Drawing for EB Series Gen3

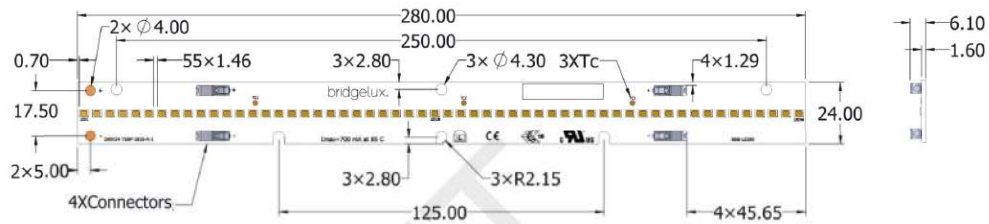

Table 4: Dimensions for 280mm

Parameter	Specification	Unit
Linear length	280	mm
Linear width	20	mm
Linear thickness	6.1	mm
PCB thickness	1.6	mm

Figure 13: Drawing for EB Series Gen3 560mm

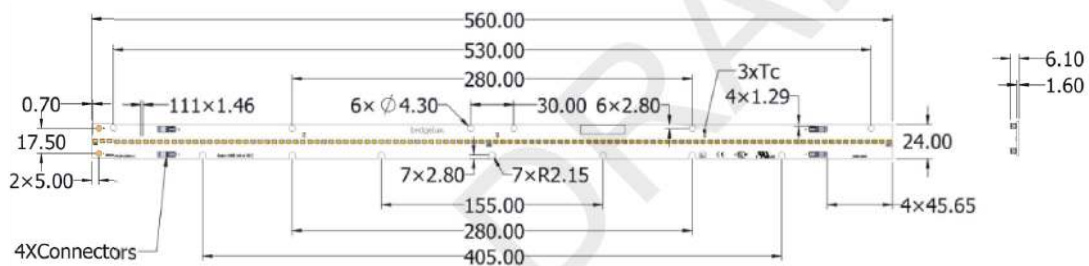
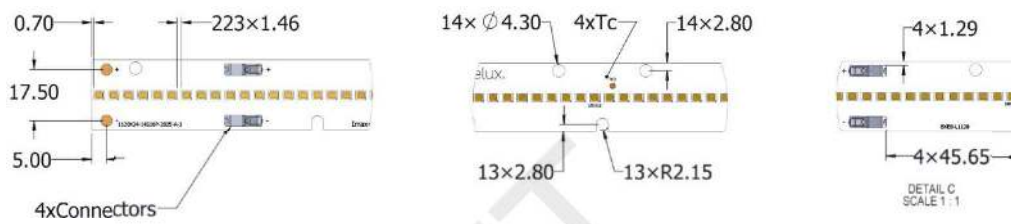

Table 5: Dimensions for 560mm

Parameter	Specification	Unit
Linear length	560	mm
Linear width	20	mm
Linear thickness	6.1	mm
PCB thickness	1.6	mm

Mechanical Dimensions

Figure 14: Drawing for EB Series Gen3 1120mm



Notes for Figures 12, 13 & 14:

1. Solder pads are labeled "+" to denote positive polarity, and "-" to denote negative polarity.
2. Drawings are not to scale.
3. Drawing dimensions are in millimeters.
4. Refer to Bridgelux assembly drawing 15-000682, 15-000683, and 15-000684 for complete product configuration

Table 6: Dimensions for 1120mm

Parameter	Specification	Unit
Linear length	1120	mm
Linear width	20	mm
Linear thickness	6.1	mm
PCB thickness	1.6	mm

Table 7: Connector and wiring

Parameter	Specification
Input wire cross-section	18-24 AWG
Wire strip length	7-9 mm

Color Binning Information

Figure 15: Graph of Warm and Neutral White Test Bins in xy Color Space

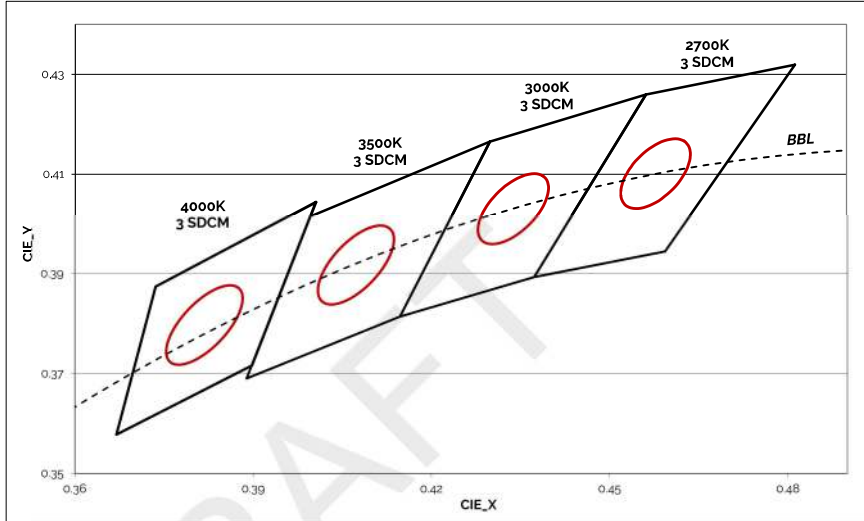

Table 8: Warm and Neutral White xy Bin Coordinates and Associated Typical CCT

Bin Code	2700K	3000K	3500 K	4000K
B3 (3 SDCM) CCT Range	2651K - 2794K	2968K - 3136K	3369K - 3586K	3851K - 4130K
Center Point (x, y)	(0.458, 0.410)	(0.434, 0.403)	(0.407, 0.392)	(0.382, 0.380)
ANSI Bin (for reference only)	(2580K - 2870K)	(2870K - 3220K)	(3220K - 3710K)	(3710K - 4260K)

Figure 16: Graph of Cool White Test Bins in xy Color

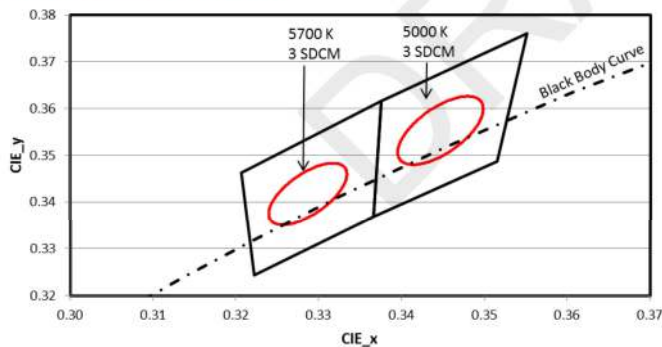

Table 9: Cool White xy Bin Coordinates and Associated Typical CCT

Bin Code	5000K	5700K
B3 (3 SDCM) CCT Range	4835K - 5215K	5490K - 5820K
Center Point (x, y)	(0.3445, 0.355)	(0.329, 0.342)
ANSI Bin (for reference only)	(4745K - 5311K)	(5312K - 6022K)

Notes for Tables 8 and 9

1. Color binning at solder point temperature T_{sp} of SMDs at 85°C.
2. Bridgelux maintains a tolerance of ± 0.007 on x and y color coordinates in the CIE 1931 color space.

Packaging and Labeling

Figure 17: EB Series Packaging and Labeling

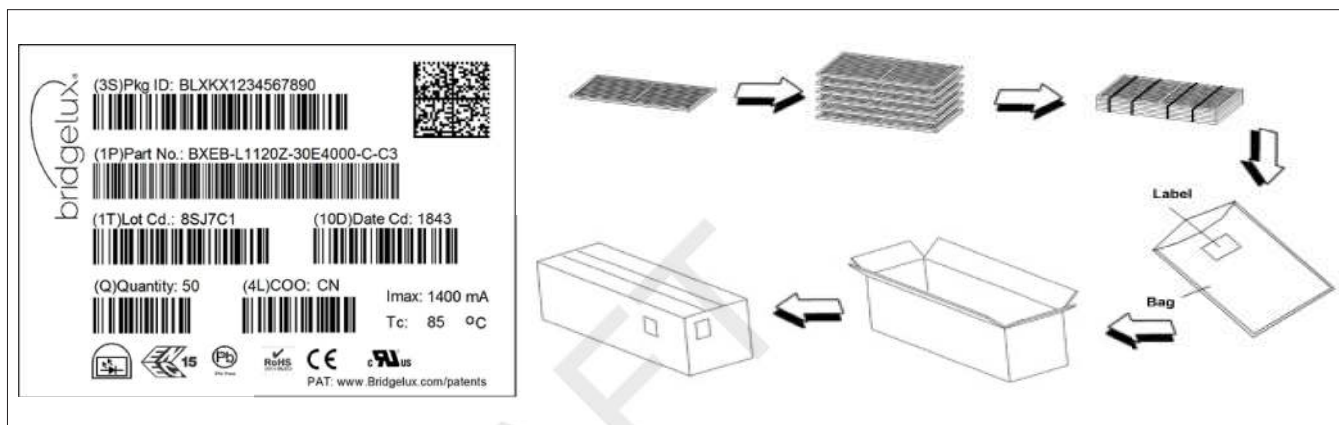

Table 10: Packaging Structure

L0280 modules	Tray	Box
Quantity	40	200
Dimension	63 cm x 39 cm x 2.4 cm	65.5 cm x 41.5 cm x 15.5 cm
L0560 modules	Tray	Box
Quantity	20	100
Dimension	63 cm x 39 cm x 2.4 cm	65.5 cm x 41.5 cm x 15.5 cm
L1120 modules	Tray	Box
Quantity	20	100
Dimension	119 cm x 39 cm x 2.4 cm	134 cm x 44 cm x 18.5 cm

Figure 18: Product Labeling

Bridgelux EB Series modules contain a label on the front to help with product identification. In addition to the product identification markings, Bridgelux EB Series modules also contain markings for internal Bridgelux manufacturing use only. The image below shows which markings are for customer use and which ones are for Bridgelux internal use only. The Bridgelux internal manufacturing markings are subject to change without notice, however these will not impact the form, function or performance of the module.



EB Series Gen3
1ft 1000lm 350mA

Customer Use- 2D Barcode
Scannable barcode provides
product part number and other
Bridgelux internal production
information.

Design Resources

Application Notes

Bridgelux has developed a comprehensive set of application notes and design resources to assist customers in successfully designing with the EB Series product family. For a list of resources under development, visit www.bridgelux.com.

Optical Source Models

Optical source models and ray set files are available for all Bridgelux products. For a list of available formats, visit www.bridgelux.com.

3D CAD Models

Three dimensional CAD models depicting the product outline of all Bridgelux EB Series LED linears are available in both IGES and STEP formats. Please contact your Bridgelux sales representative for assistance.

Precautions

CAUTION: CHEMICAL EXPOSURE HAZARD

Exposure to some chemicals commonly used in luminaire manufacturing and assembly can cause damage to the LED linear. Please consult Bridgelux Application Note for additional information.

CAUTION: EYE SAFETY

Eye safety classification for the use of Bridgelux EB Series is in accordance with IEC/TR62778: Application of IEC 62471 for the assessment of blue light hazard to light sources and luminaires. EB Series linears are classified as Risk Group 1 when operated at or below the maximum drive current. Please use appropriate precautions. It is important that employees working with LEDs are trained to use them safely.

CAUTION: RISK OF BURN

Do not touch the EB Series linears during operation. Allow the linear to cool for a sufficient period of time before handling. The EB Series linears may reach elevated temperatures such that could burn skin when touched.

CAUTION

CONTACT WITH LIGHT EMITTING SURFACE (LES)

Avoid any contact with the LES. Do not touch the LES of the linear or apply stress to the LES (yellow phosphor resin area). Contact may cause damage to the linear.

Optics and reflectors must not be mounted in contact with the LES (yellow phosphor resin area).

Optical

devices may be mounted on the top surface of the EB Series linear. Use the mechanical features of the linear housing, edges and/or mounting holes to locate and secure optical devices as needed.

Disclaimers

STANDARD TEST CONDITIONS

Unless otherwise stated, linear testing is performed at the nominal drive current.

MINOR PRODUCT CHANGE POLICY

The rigorous qualification testing on products offered by Bridgelux provides performance assurance. Slight cosmetic changes that do not affect form, fit, or function may occur as Bridgelux continues product optimization.

About Bridgelux: Bridging Light and Life™

At Bridgelux, we help companies, industries and people experience the power and possibility of light. Since 2002, we've designed LED solutions that are high performing, energy efficient, cost effective and easy to integrate. Our focus is on light's impact on human behavior, delivering products that create better environments, experiences and returns—both experiential and financial. And our patented technology drives new platforms for commercial and industrial luminaires.

For more information about the company, please visit

bridgelux.com

twitter.com/Bridgelux

facebook.com/Bridgelux

youtube.com/user/Bridgelux

linkedin.com/company/bridgelux

WeChat ID: BridgeluxInChina



46430 Fremont Blvd
Fremont, CA 94538 USA
Tel (925) 583-8400
Fax (925) 583-8401
www.bridgelux.com

© 2021 Bridgelux, Inc. All rights reserved. Product specifications are subject to change without notice. Bridgelux and the Bridgelux stylized logo design are registered trademarks of Bridgelux, Inc. EB Series and Bridging Light and Life are trademarks of Bridgelux, Inc. All other trademarks are the property of their respective owners.

Bridgelux EB Series Gen3 Data Sheet DS132 Rev. B (01/2021)