

SF1194A

167 MHz SAW Filter

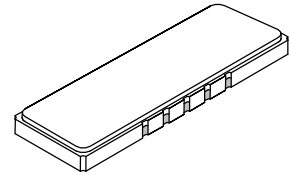

SMP-75

- **Low Insertion Loss**
- **Excellent Size-to-Performance Ratio**
- **Hermetic SMP-75 Surface-Mount Case**
- **Single-Ended or Differential Input and Output**
- **Complies with Directive 2002/95/EC (RoHS)**



Absolute Maximum Ratings

Rating	Value	Units
Maximum Incident Power in Passband	+10	dBm
Max. DC voltage between any 2 terminals	30	VDC
Temperature Range	-5 to +85	°C
Suitable for lead-free soldering - Max. Soldering Profile	260°C for 30 s	

Characteristic	Sym	Notes	Min	Typ	Max	Units
Center Frequency	f_o	1	167			MHz
Maximum Insertion Loss 167 ± .075 MHz	IL				7.0	dB
2.0 dB Bandedges					± .200	MHz
17 dB Bandedges					± .400	MHz
36 dB Bandedges					± .600	MHz
41 dB Bandedges					± .800	MHz
Ultimate Rejection						dB
30 to 147 MHz			70			dB
147 to 165.4 MHz			41			dB
168.6 to 187 MHz			41			dB
187 to 276 MHz			70			dB
276 to 278 MHz			50			dB
278 to 2000 MHz			70			dB
Amplitude Variation	167 ± 0.75 MHz				1.5	dB p-p
Amplitude Ripple	167 ± 0.75 MHz				1	dB p-p
Absolute Group Delay	167 ± 0.75 MHz			2.3	2.6	µsec
Group Delay Variation	167 ± 0.75 MHz				400	nsec
Maximum RF Input Power					22	dBm
Input IMR	For two -20dBm input signals At 167 + .800 MHz And 167 + 1.600 MHz Or at 167 -.800 MHz And 167 -1.600 MHz		100			dB
Input Return Loss	167 ± .075 MHz		15			dB
Output Return Loss	167 ± .075 MHz		10			dB
Source/Load Impedance	Single-Ended or Differential Input / Output					Ohm
Matching Components	Fixed value, external Q 40-50					
Case Style	SMP-75 19 x 6.5 mm Nominal Footprint					
Lid Symbolization (YY = year, WW = week)	RFM SF1194A YYWW					

NOTES:

1. Unless noted otherwise, all specifications apply over the operating temperature range with filter soldered to the specified demonstration board with impedance matching to 50 Ω and measured with 50 Ω network analyzer.
2. Unless noted otherwise, all frequency specifications are referenced to the nominal center frequency, fc.
3. The design, manufacturing process, and specifications of this filter are subject to change.
4. Tape and Reel Standard ANSI / EIA 481.
5. US and international patents may apply.
6. Murata, stylized Murata logo, and Murata N.A., Inc. are registered trademarks of Murata Manufacturing Co., Ltd
7. Electrostatic Sensitive Device. Observe precautions for handling.



SMP-75 Case

10-Terminal Ceramic Surface-Mount Case 19 x 6.5 mm Nominal Footprint

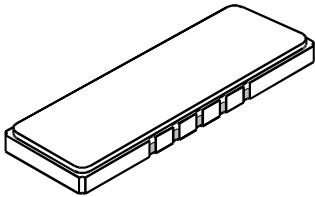

Dimension	Case Dimensions					
	mm			Inches		
	Min	Nom	Max	Min	Nom	Max
A	18.80	19.00	19.30	0.740	0.748	0.760
B	6.30	6.50	6.80	0.248	0.256	0.268
C		1.75	2.00		0.069	0.079
D		2.29			0.090	
E		1.02			0.040	
H		1.0			0.039	
P		1.905			0.075	

Materials	
Solder Pad Termination	Au plating 30 - 60 μinches (76.2-152 μm) over 80-200 μinches (203-508 μm) Ni.
Lid	Fe-Ni-Co Alloy Electroless Nickel Plate (8-11% Phosphorus) 100-200 μinches Thick
Body	Al ₂ O ₃ Ceramic
Pb Free	

Electrical Connections		
Connection		Terminals
Port 1	Input or Return	10
	Return or Input	1
Port 2	Output or Return	5
	Return or Output	6
Ground		All others
Single Ended Operation		Return is ground
Differential Operation		Return is hot

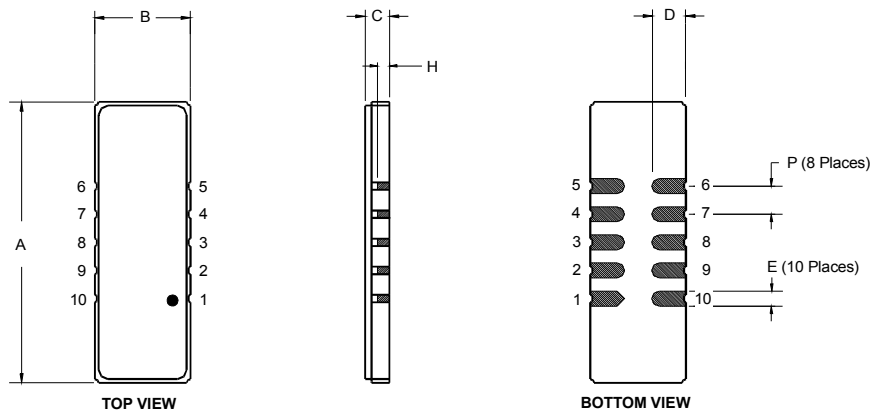

Tape and Reel Specifications

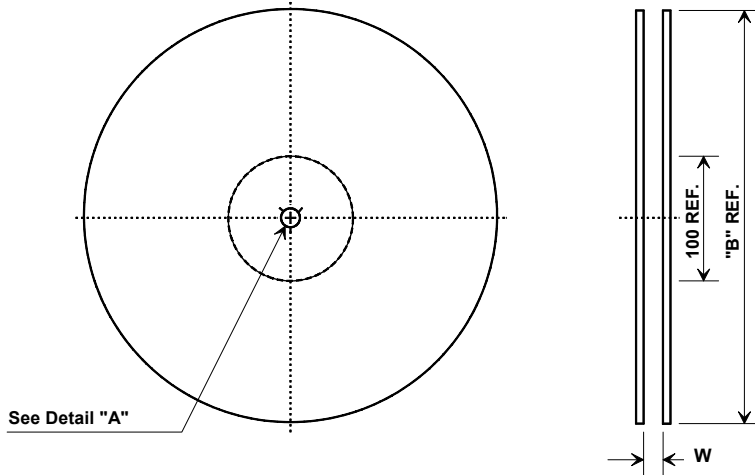

Tape and Reel Packaging with the following conditions:

Tape Width: 32 mm

Tape Pitch (part to part): 12 mm

Component Orientation: Parts shall be oriented with the narrow side closest to the tape's round sprocket holes on the tape's trailing edge.

See Detail "A"

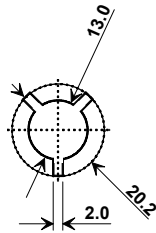

"B "		Quantity Per Reel
Nominal Size		
Inches	millimeters	
7	178	500
13	330	1000

COMPONENT ORIENTATION and DIMENSIONS

Carrier Tape Dimensions		Cover Tape
Ao	.276 ± .004 (7.01)	25.5 mm
Bo	.768 ± .004 (19.51)	
Ko	.088 ± .004 (2.24)	
Pitch	12mm	
W	32mm	

COVER TAPE SIZE

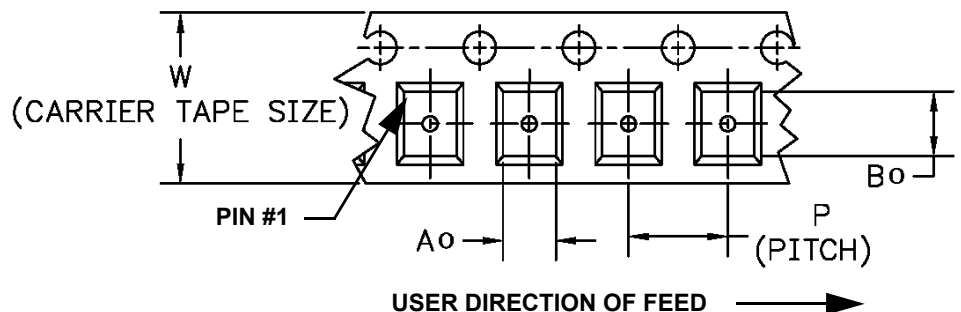
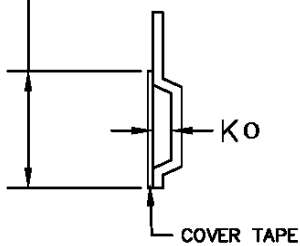

Assembly Diagram

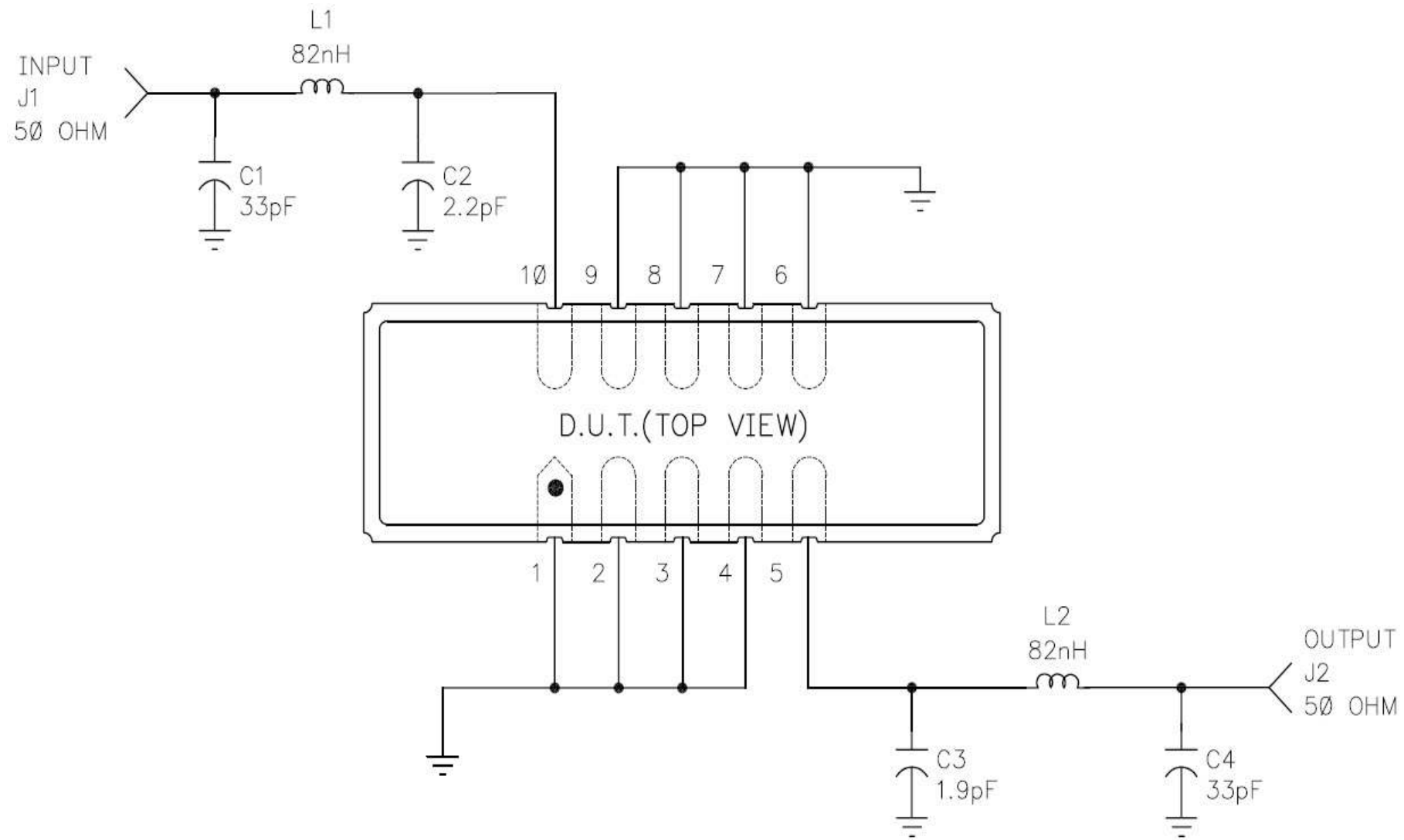

Inductor Pairs

NOTES:

1. NOTE PROPER ORIENTATION OF INDUCTOR PAIRS L1 & L2. THEY ARE TO BE POSITIONED 90° TO EACH OTHER.
2. SOLDER SURFACE MOUNT PACKAGE TO TEST SIDE OF PCB. SOLDER IN PLACES AS SHOWN. NOTE PIN 1 INDICATOR.
3. SOLDER CONNECTOR FLANGES ON BOTH SIDES OF PCB.
4. SOLDER SHIELD AS SHOWN.

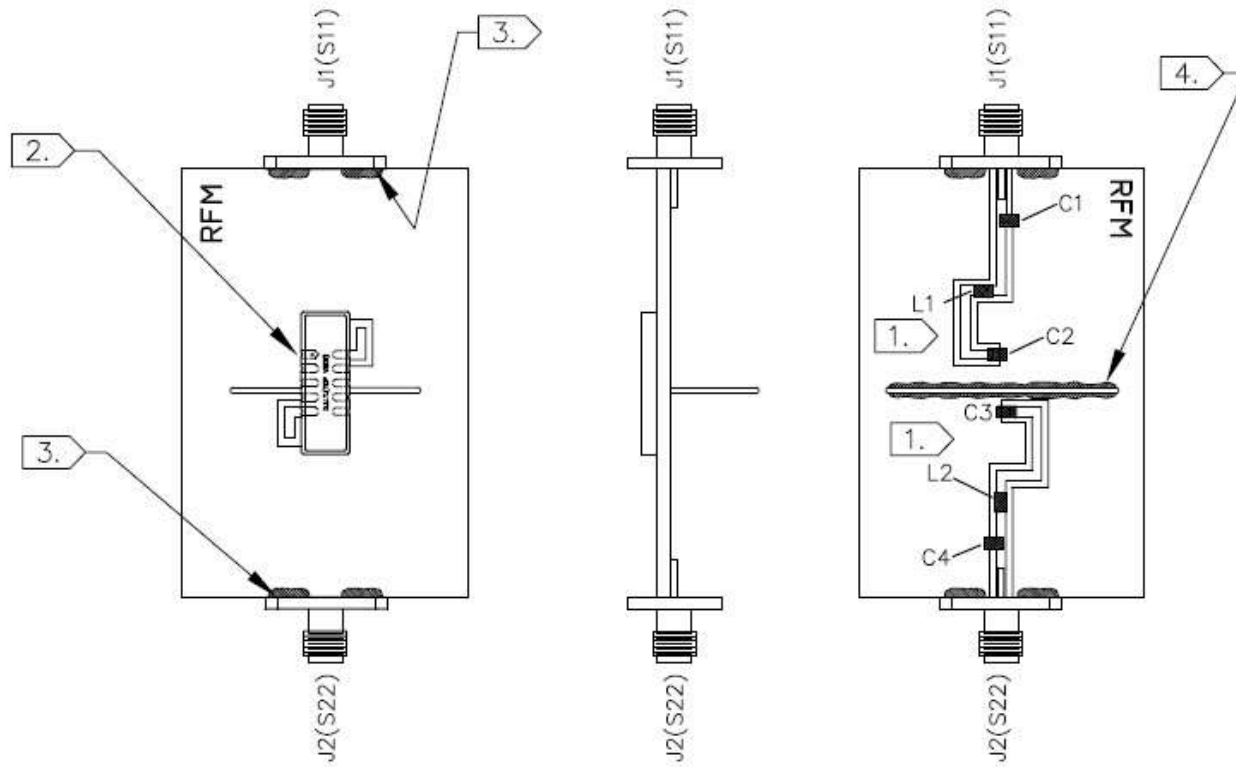

Frequency Characteristics

29 Apr 2003 09:00:21

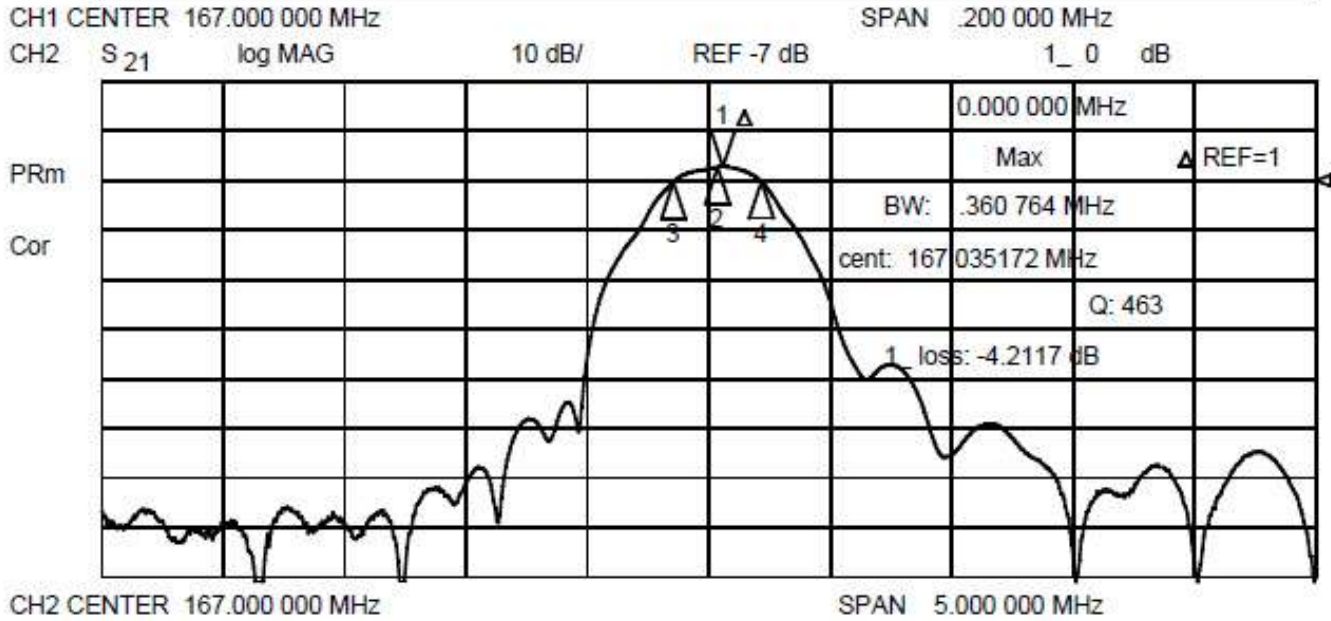
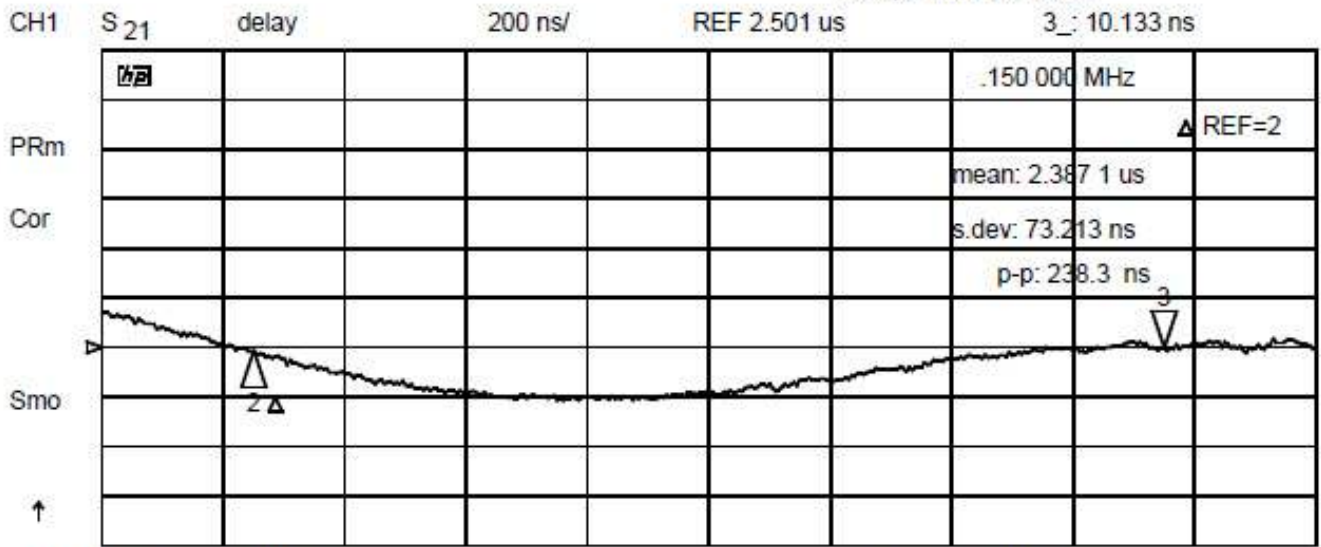

Copyright © Murata Manufacturing Co., Ltd. All Rights Reserved 2003

Frequency Characteristics

29 Apr 2003 09:07:21

CH1 S₁₁ 1 UFS

1_ 62.74

Ω 6.4785

Ω 6.1742 nH

PRm

Cor

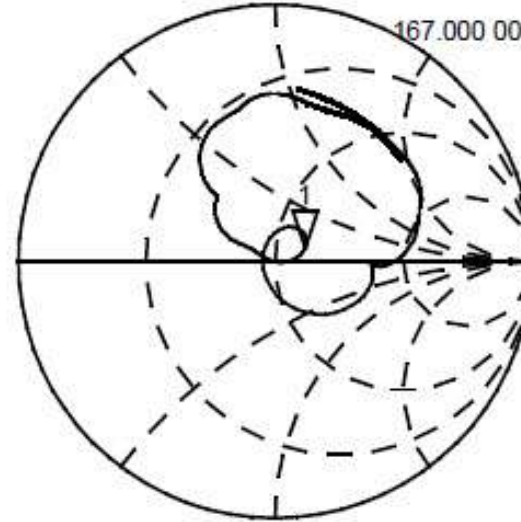

↑

CH2 S₂₂ 1 UFS

1_ 46.176

Ω -28.381

Ω 33.58 pF

PRm

Cor

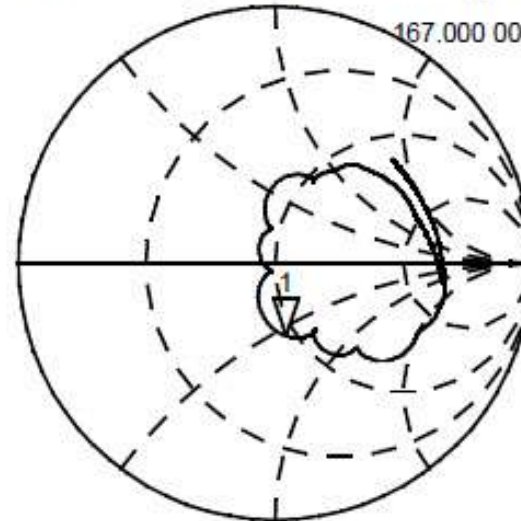

↑

CENTER 167.000 000 MHz

SPAN 5.000 000 MHz

Copyright © Murata Manufacturing Co., Ltd. All Rights Reserved 2003

Frequency Characteristics

29 Apr 2003 09:09:30

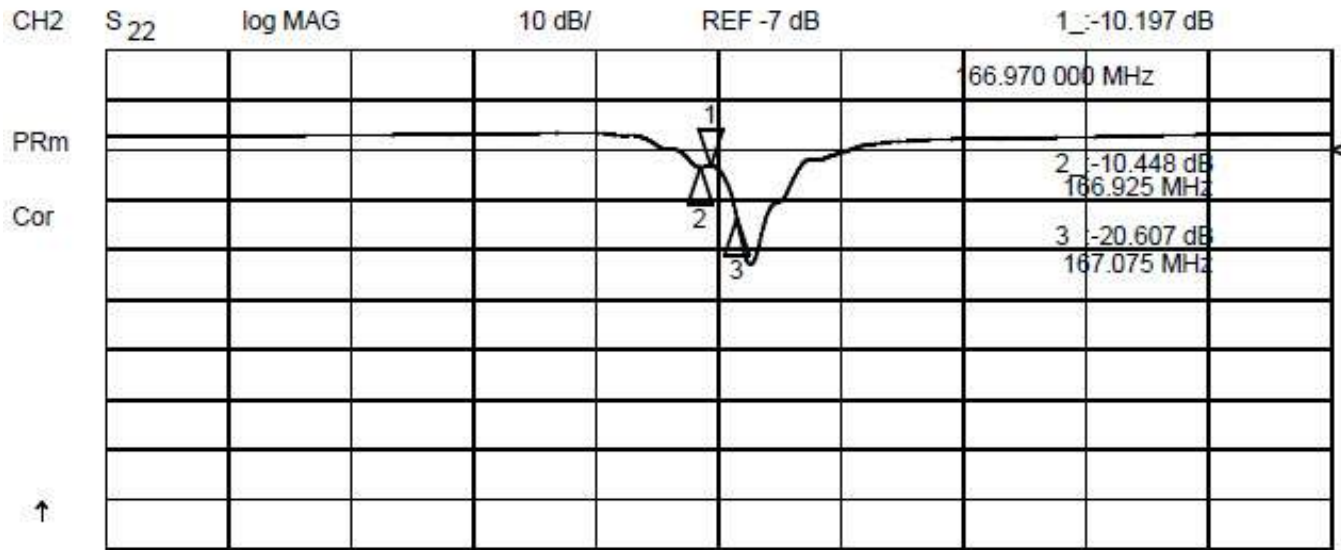
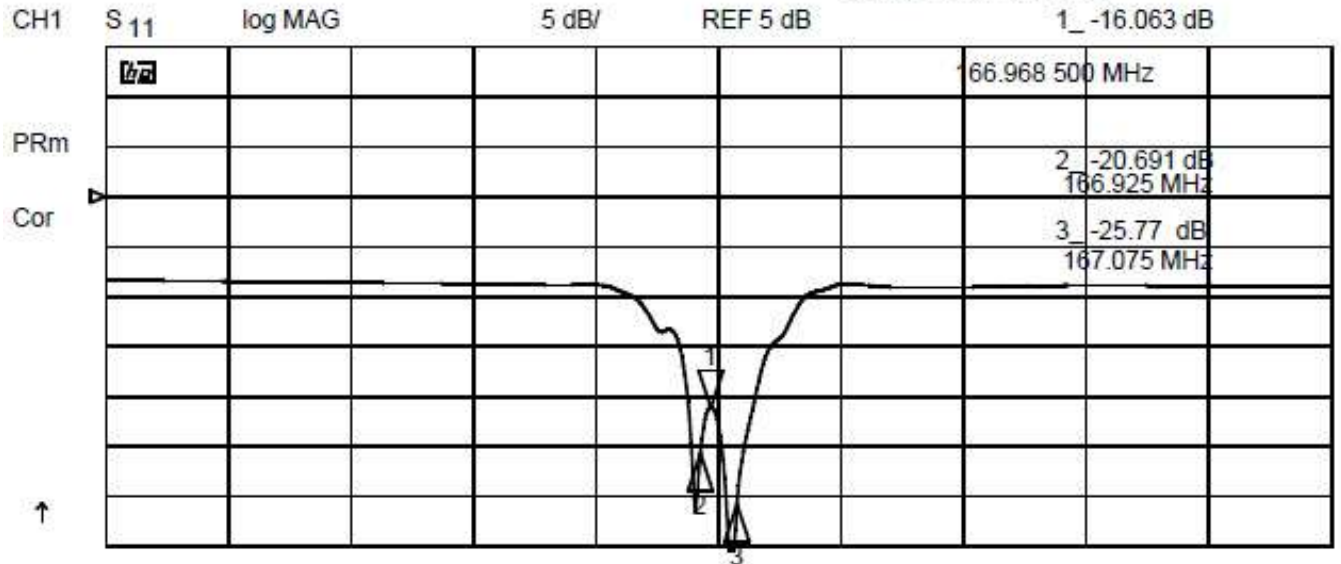

CENTER 167.000 000 MHz

SPAN 5.000 000 MHz

Copyright © Murata Manufacturing Co., Ltd. All Rights Reserved 2003

Frequency Characteristics

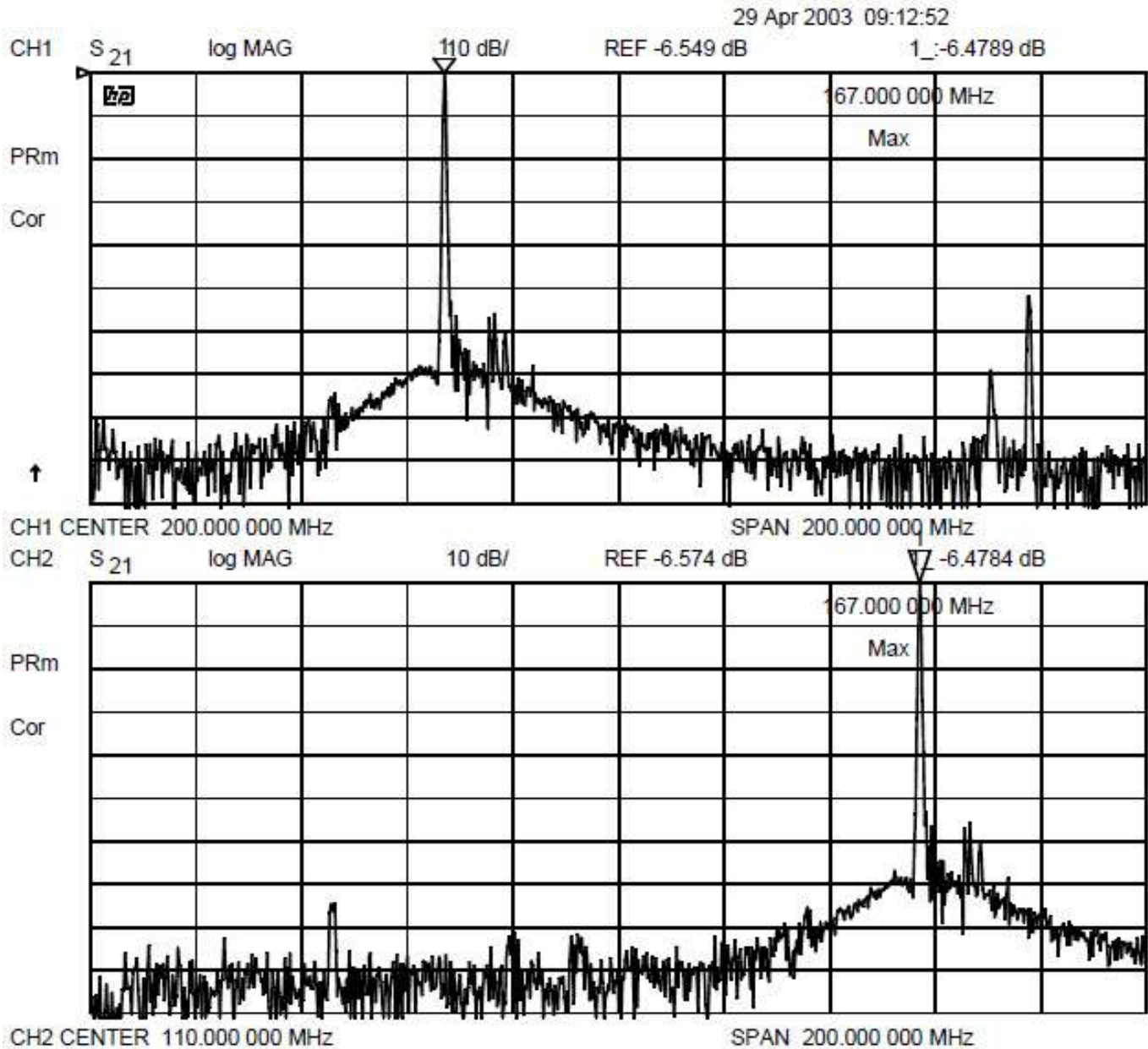

Copyright © Murata Manufacturing Co., Ltd. All Rights Reserved 2003

Frequency Characteristics

29 Apr 2003 09:14:48

