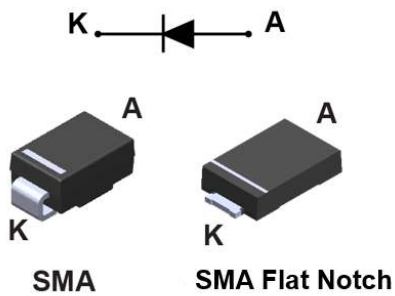

## 150 V, 1 A power Schottky rectifier

**DO-41**

### Features

- Negligible switching losses
- Low forward voltage drop for higher efficiency and extended battery life
- Low thermal resistance
- Surface mount miniature package
- Avalanche capability
- [ECOPACK2](#) compliant component

### Applications

- Switching diode
- SMPS
- DC/DC converter
- Telecom power

### Description

This 150 V power Schottky rectifier is ideal for switch mode power supplies on up to 24 V rails and high frequency converters.

Packaged in SMA, SMA Flat Notch and axial, the [STPS1150](#) is optimized for use in consumer and computer applications where low drop forward voltage is required to reduce power dissipation.

Product status	
STPS1150	
Product summary	
Symbol	Values
$I_{F(AV)}$	1 A
$V_{RRM}$	150 V
$T_j(max.)$	175 °C
$V_F(typ.)$	0.62 V

# 1 Characteristics

**Table 1. Absolute ratings (limiting values, at 25 °C, unless otherwise specified)**

Symbol	Parameter		Value	Unit	
$V_{RRM}$	Repetitive peak reverse voltage		150	V	
$I_{F(RMS)}$	Forward rms current		15	A	
$I_{F(AV)}$	Average forward current $\delta = 0.5$ , square wave	SMA	$T_L = 150\text{ °C}$	1	A
		SMA Flat Notch	$T_L = 160\text{ °C}$		
		DO-41	$T_L = 150\text{ °C}$		
$I_{FSM}$	Surge non repetitive forward current	SMA	$t_p = 10\text{ ms sinusoidal}$	50	A
		SMA Flat Notch		50	
		DO-41		75	
$P_{ARM}$	Repetitive peak avalanche power	$t_p = 10\text{ }\mu\text{s}, T_j = 125\text{ °C}$	108	W	
$T_{stg}$	Storage temperature range		-65 to + 175	°C	
$T_j$	Maximum operating junction temperature <sup>(1)</sup>		+ 175	°C	

1.  $(dP_{tot}/dT_j) < (1/R_{th(j-a)})$  condition to avoid thermal runaway for a diode on its own heatsink.

**Table 2. Thermal resistance parameter**

Symbol	Parameter		Max. value	Unit	
$R_{th(j-l)}$	Junction to lead		SMA	30	°C/W
			SMA Flat Notch	20	
	Junction to lead	Lead length = 10 mm	DO-41	30	

For more information, please refer to the following application note :

- AN5088 : Rectifiers thermal management, handling and mounting recommendations

**Table 3. Static electrical characteristics**

Symbol	Parameter	Test conditions		Min.	Typ.	Max.	Unit
$I_R^{(1)}$	Reverse leakage current	$T_j = 25\text{ °C}$	$V_R = V_{RRM}$	-	0.2	1.0	$\mu\text{A}$
		$T_j = 125\text{ °C}$		-	0.2	1.0	mA
$V_F^{(2)}$	Forward voltage drop	$T_j = 25\text{ °C}$	$I_F = 1\text{ A}$	-	0.78	0.82	V
		$T_j = 125\text{ °C}$		-	0.62	0.67	
		$T_j = 25\text{ °C}$	$I_F = 2\text{ A}$	-	0.85	0.89	
		$T_j = 125\text{ °C}$		-	0.69	0.75	

1. Pulse test:  $t_p = 5\text{ ms}, \delta < 2\%$

2. Pulse test:  $t_p = 380\text{ }\mu\text{s}, \delta < 2\%$

To evaluate the conduction losses use the following equation:  $P = 0.59 \times I_{F(AV)} + 0.08 I_{F(RMS)}^2$

For more information, please refer to the following application notes related to the power losses :

- AN604: Calculation of conduction losses in a power rectifier
- AN4021: Calculation of reverse losses on a power diode

## 1.1 Characteristics (curves)

**Figure 1. Average forward power dissipation versus average forward current**

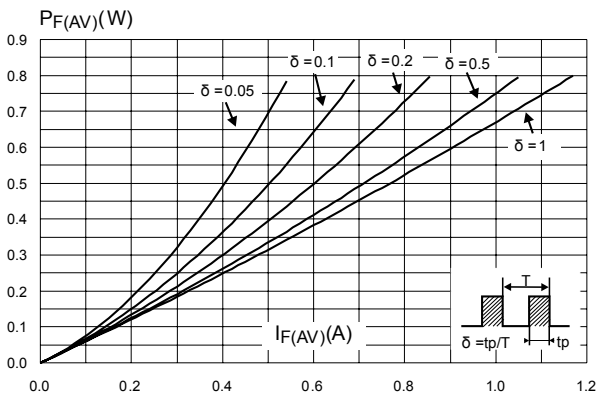

**Figure 2. Average forward current versus ambient temperature ( $\delta = 0.5$ )**

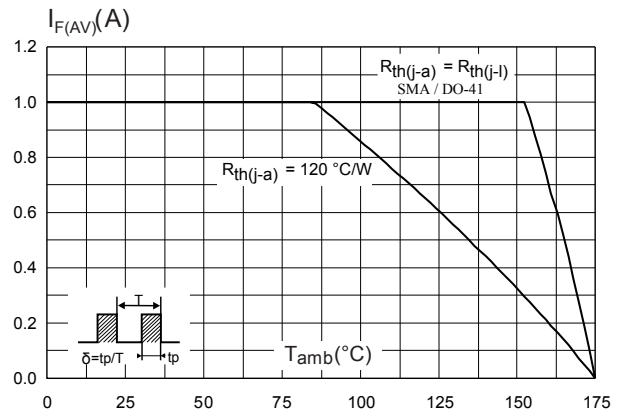

**Figure 3. Normalized avalanche power derating versus pulse duration ( $T_j = 125 \text{ °C}$ )**

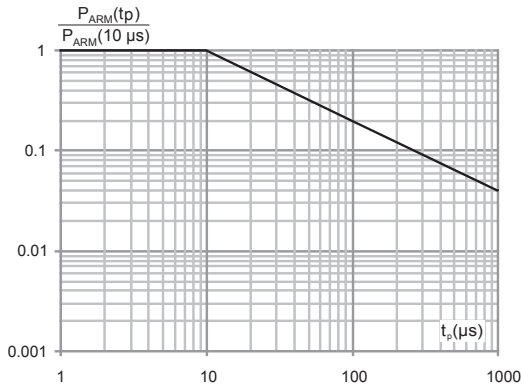

**Figure 4. Relative variation of thermal impedance junction to ambient versus pulse duration (SMA)**

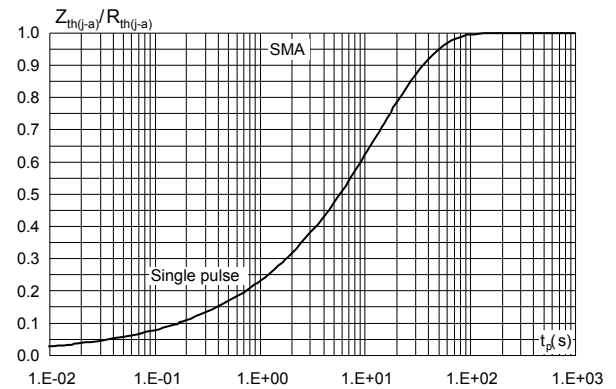

**Figure 5. Relative variation of thermal impedance junction to ambient versus pulse duration (DO-41)**

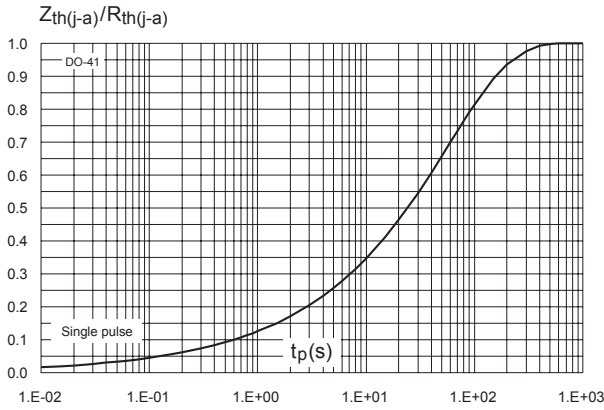

**Figure 6. Reverse leakage current versus reverse voltage applied (typical values)**

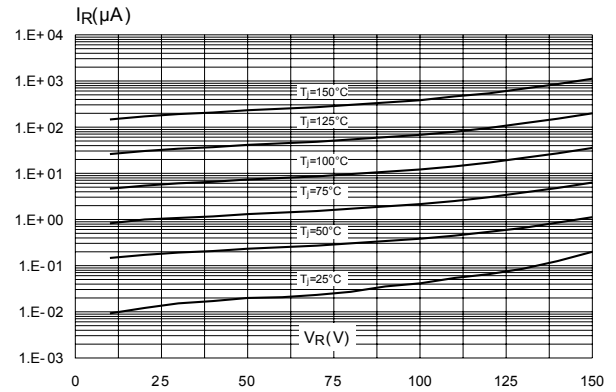

**Figure 7. Junction capacitance versus reverse voltage applied (typical values)**

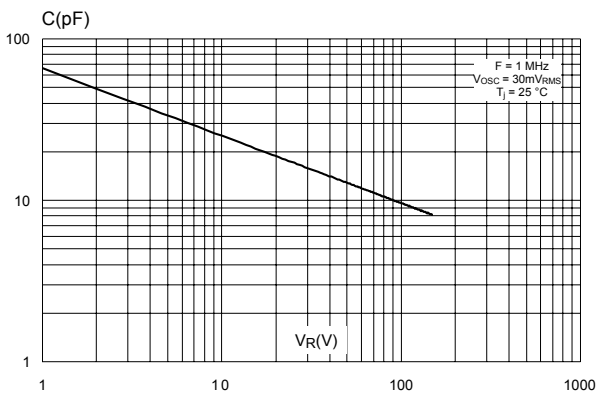

**Figure 8. Forward voltage drop versus forward current**

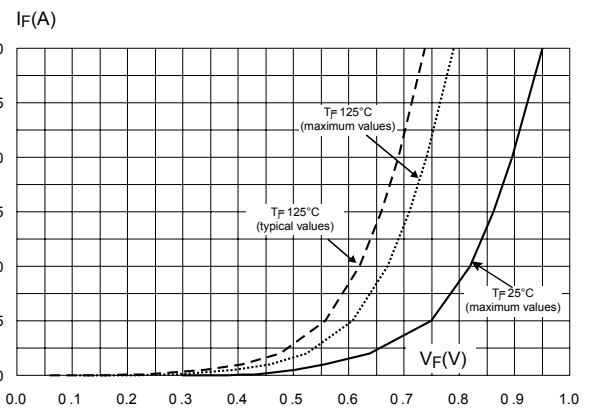

**Figure 9. Thermal resistance junction to ambient versus copper surface under each lead (SMA)**

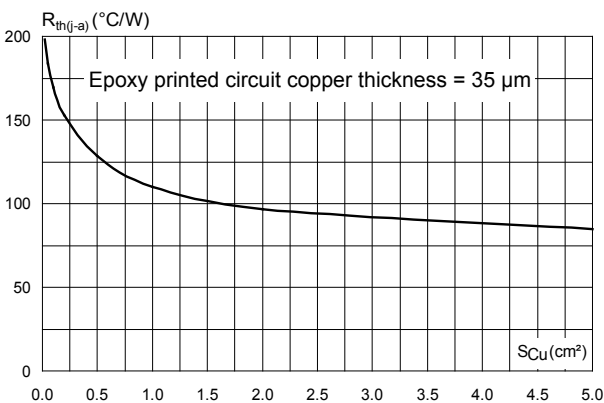

**Figure 10. Thermal resistance versus lead length (DO-41)**

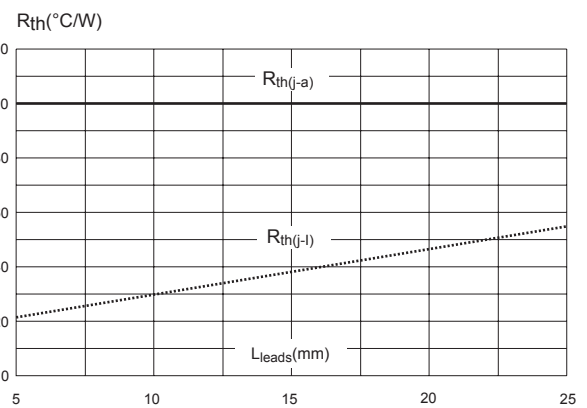
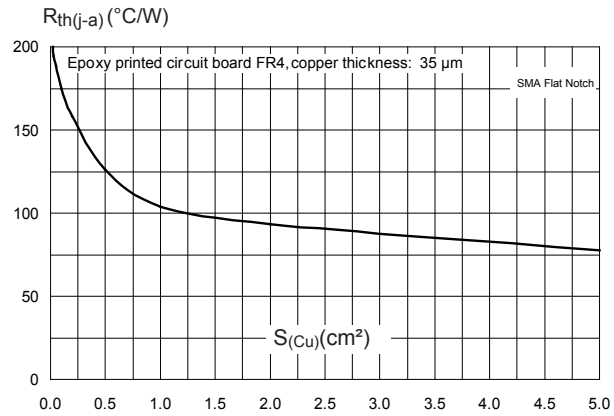

Figure 11. Thermal resistance junction to ambient versus copper surface under each lead (SMA Flat Notch)



## 2 Package information

In order to meet environmental requirements, ST offers these devices in different grades of **ECOPACK** packages, depending on their level of environmental compliance. ECOPACK specifications, grade definitions and product status are available at: [www.st.com](http://www.st.com). ECOPACK is an ST trademark.

### 2.1 SMA package information

- Epoxy meets UL 94, V0
- Cooling method : by conduction (C)

Figure 12. SMA package outline

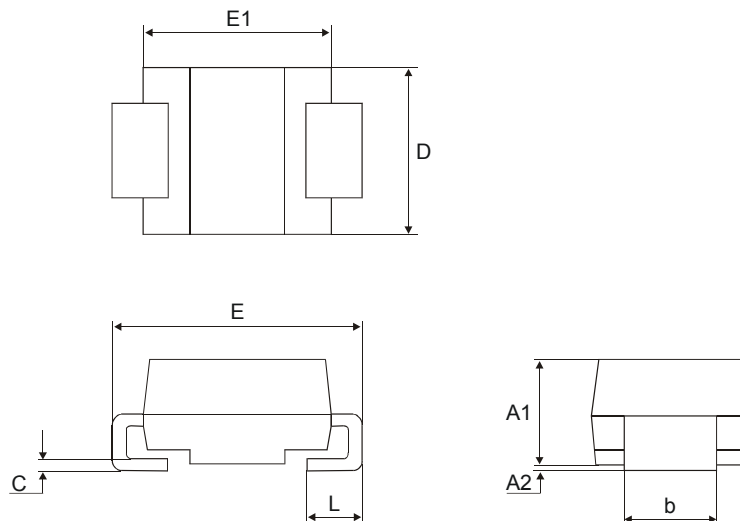
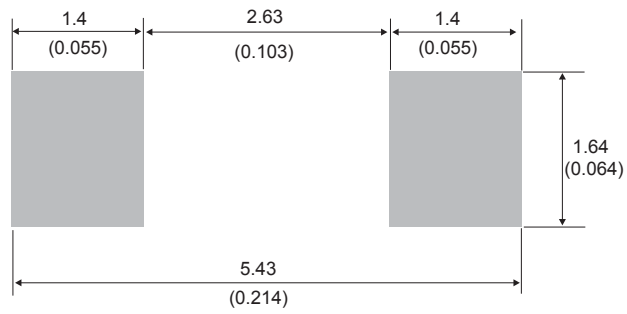

Table 4. SMA package mechanical data

Ref.	Dimensions					
	Millimeters			Inches (for reference only)		
	Min.	Typ.	Max.	Min.	Typ.	Max.
A1	1.90	-	2.45	0.075	-	0.097
A2	0.05	-	0.20	0.002	-	0.008
b	1.25	-	1.65	0.049	-	0.065
C	0.15	-	0.40	0.006	-	0.016
D	2.25	-	2.90	0.089	-	0.114
E	4.80	-	5.35	0.189	-	0.211
E1	3.95	-	4.60	0.156	-	0.181
L	0.75	-	1.50	0.030	-	0.059

Figure 13. SMA recommended footprint in mm (inches)



## 2.2 SMA Flat Notch package information

- Epoxy meets UL94, V0
- Cooling method: by conduction (C)
- Band indicates cathode

Figure 14. SMA Flat Notch package outline

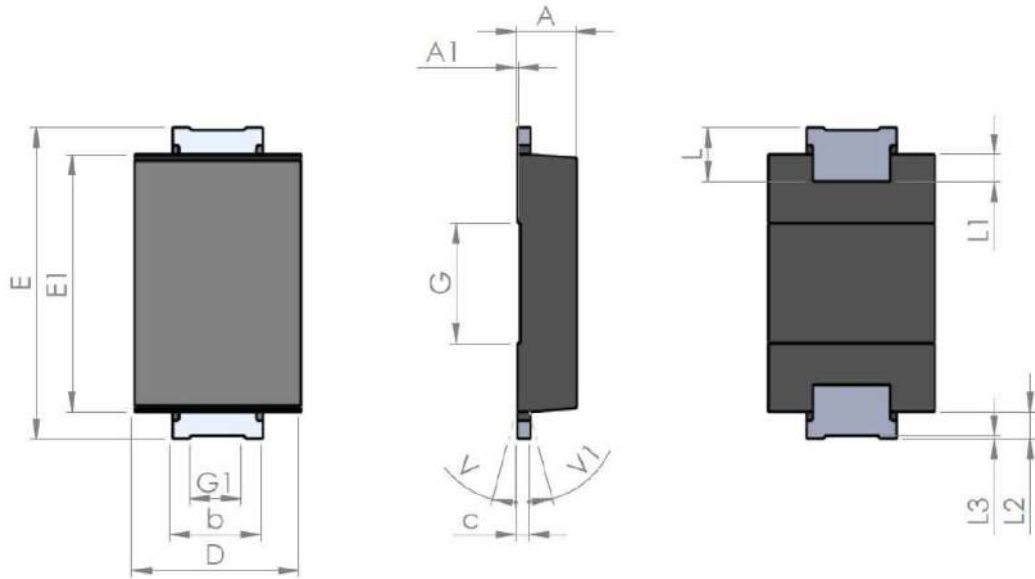
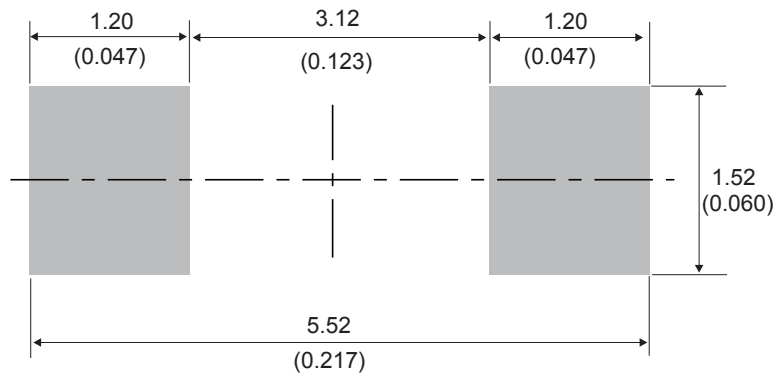

Table 5. SMA Flat Notch package mechanical data

Ref.	Dimensions					
	Millimeters			Inches (for reference only)		
	Min.	Typ.	Max.	Min.	Typ.	Max.
A1	0.90		1.10	0.035		0.044
A1		0.05			0.002	
b	1.25		1.65	0.049		0.065
C	0.15		0.40	0.005		0.016
D	2.25		2.90	0.088		0.115
E	5.00		5.35	0.196		0.211
E1	3.95		4.60	0.155		0.182
G		2.00			0.079	
G1		0.85			0.033	
L	0.75		1.20	0.029		
L1		0.45			0.018	
L2		0.45			0.018	
L3		0.05			0.002	
V			8°			8°
V1			8°			8°



Figure 15. SMA Flat Notch recommended footprint in mm (inches)



### 2.3 DO-41 package information

- Epoxy meets UL 94, V0

Figure 16. DO-41 package outline

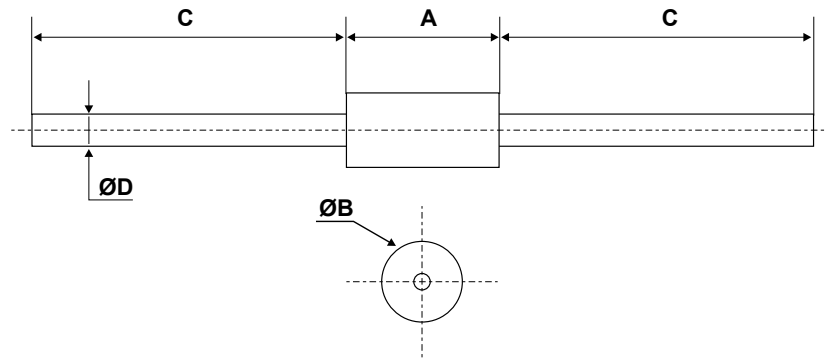

Table 6. DO-41 package mechanical data

Ref.	Dimensions					
	Millimeters			Inches (for reference only)		
	Min.	Typ.	Max.	Min.	Typ.	Max.
A	4.1	-	5.20	0.160	-	0.205
B	2.00	-	2.71	0.080	-	0.107
C	25.40	-		1.000	-	
D	0.71	-	0.86	0.028	-	0.0034

### 3 Ordering Information

**Table 7. Ordering information**

Order code	Marking	Package	Weight	Base qty.	Delivery mode
STPS1150AFN	A1150	SMA Flat Notch	0.039 g	10 000	Tape and reel
STPS1150A	1150	SMA	0.068 g	5000	Tape and reel
STPS1150	STPS1150	DO-41	0.34 g	2000	Ammopack
STPS1150RL	STPS1150	DO-41	0.34 g	5000	Tape and reel

## Revision history

**Table 8. Document revision history**

Date	Version	Changes
Jul-2003	2A	Last update.
Aug-2004	3	SMA package dimensions update. Reference A1 max. changed from 2.70 mm (0.106) to 2.03 mm (0.080).
31-May-2006	4	Reformatted to current standard. Added ECOPACK statement. Updated SMA footprint in Figure 15. Changed nF to pF in Figure 10.
09-Feb-2011	5	Added STmite and STmite flat package.
15-Apr-2014	6	Updated : Features, Table 2, 3 and Figure 2. Updated Section 2: Package information.
28-Sep-2018	7	Removed STmite and STmite flat package information. Updated Table 1. Absolute ratings (limiting values, at 25 °C, unless otherwise specified) and Figure 3. Normalized avalanche power derating versus pulse duration ( $T_j = 125\text{ °C}$ ).
25-Sep-2019	8	Added Section 2.2 SMA Flat Notch package information.

**IMPORTANT NOTICE – PLEASE READ CAREFULLY**

STMicroelectronics NV and its subsidiaries (“ST”) reserve the right to make changes, corrections, enhancements, modifications, and improvements to ST products and/or to this document at any time without notice. Purchasers should obtain the latest relevant information on ST products before placing orders. ST products are sold pursuant to ST’s terms and conditions of sale in place at the time of order acknowledgement.

Purchasers are solely responsible for the choice, selection, and use of ST products and ST assumes no liability for application assistance or the design of Purchasers’ products.

No license, express or implied, to any intellectual property right is granted by ST herein.

Resale of ST products with provisions different from the information set forth herein shall void any warranty granted by ST for such product.

ST and the ST logo are trademarks of ST. For additional information about ST trademarks, please refer to [www.st.com/trademarks](http://www.st.com/trademarks). All other product or service names are the property of their respective owners.

Information in this document supersedes and replaces information previously supplied in any prior versions of this document.

© 2019 STMicroelectronics – All rights reserved