

CAR SERIES

2W REGULATED

DANUBE

FEATURES

- DUAL IN LINE PACKAGE
- UP TO 2W REGULATED OUTPUT POWER
- 100% BURNED IN
- HIGH EFFICIENCY
- FIVE-SIDED SHIELD TO REDUCE EMI
- LOW COST
- NO EXTERNAL COMPONENTS REQUIRED
- UL 94V-0 PACKAGE MATERIAL
- CUSTOM SOLUTIONS AVAILABLE
- 3 YEARS WARRANTY

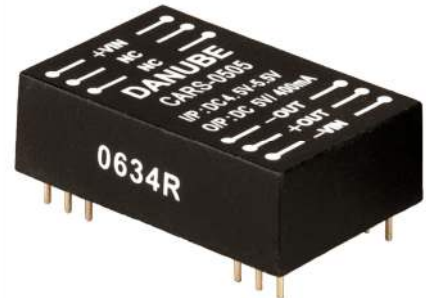

OUTPUT SPECIFICATIONS

Voltage Setpoint Accuracy	+/-3% max
Temperature Coefficient	+/-0.05%/°C
Ripple & Noise(20MHz BW)	100mVp-p max
Line Regulation ¹	+/-1% max
Load Regulation ²	+/-1% max
Minimum Load	10% of Full Load
Short Circuit Protection	Current Limit Protection
Short Circuit Restart	Automatic
Transient Response ⁴	200uS max

INPUT SPECIFICATIONS

Input Voltage Range	+/-10% max
Input Filter	Pi Network
Protection	Fuse Recommended

GENERAL SPECIFICATIONS

Efficiency	58% min
Isolation Voltage ³	1500 VDC min
Isolation Resistance	10 ⁹ ohms min
Isolation Capacitance	80pF max
Switching Frequency	50KHz min
MTBF ⁵	>850,000 Hours
Weight	12.0g-14.4g
Case Material	Non-Conductive Plastic Or Five-Sided Shield Case
Case Size	31.8mm*20.3mm*10.2mm
Conducted Emissions	EN55022 Class A
Radiated Emissions	EN55022 Class A

ENVIRONMENTAL SPECIFICATIONS

Operating Temperature	-25 °C to +71 °C
Storage Temperature	-55 °C to +125 °C
Humidity	95% max
Cooling	Free-Air Convection

ALL SPECIFICATIONS TYPICAL AT NOMINAL LINE, FULL LOAD, AND 25°C UNLESS OTHERWISE NOTED.

¹ High Line to Low Line.

² Load Regulation is for output load current change from 10% to 100%.

³ For 10 seconds.

⁴ 25% Step Load Change.

⁵ MIL-HDBK-217F @25 °C, Ground Benign.

● SELECTION GUIDE 2W OUTPUT

MODEL NUMBER ⁶	INPUT VOLTAGE (VDC)	OUTPUT VOLTAGE (VDC)	OUTPUT CURRENT (mA)	INPUT ⁷		EFF (%) ⁸	ISOLATION (VDC)
				CURRENT(mA)			
				FULL LOAD	NO LOAD		
CARS-0505(M)	4.5-5.5	5	400	727	64	55	1500
CARS-0509(M)	4.5-5.5	9	222	635	50	63	1500
CARS-0512(M)	4.5-5.5	12	167	615	50	65	1500
CARS-0515(M)	4.5-5.5	15	133	625	50	64	1500
CARD-0505(M)	4.5-5.5	+/-5	+/-200	696	70	57	1500
CARD-0512(M)	4.5-5.5	+/-12	+/-84	680	63	59	1500
CARD-0515(M)	4.5-5.5	+/-15	+/-67	641	80	62	1500
CARS-1205(M)	10.8-13.2	5	400	273	20	61	1500
CARS-1209(M)	10.8-13.2	9	222	265	20	63	1500
CARS-1212(M)	10.8-13.2	12	167	252	20	66	1500
CARS-1215(M)	10.8-13.2	15	133	242	20	69	1500
CARD-1205(M)	10.8-13.2	+/-5	+/-200	273	20	61	1500
CARD-1212(M)	10.8-13.2	+/-12	+/-84	270	40	62	1500
CARD-1215(M)	10.8-13.2	+/-15	+/-67	257	38	65	1500
CARS-2405(M)	21.6-26.4	5	400	132	13	63	1500
CARS-2409(M)	21.6-26.4	9	222	126	20	66	1500
CARS-2412(M)	21.6-26.4	12	167	121	13	69	1500
CARS-2415(M)	21.6-26.4	15	133	121	13	69	1500
CARD-2405(M)	21.6-26.4	+/-5	+/-200	132	13	63	1500
CARD-2412(M)	21.6-26.4	+/-12	+/-84	129	16	65	1500
CARD-2415(M)	21.6-26.4	+/-15	+/-67	132	16	63	1500
CARS-2805(M)	25.2-30.8	5	400	114	13	63	1500
CARS-4805(M)	43.2-52.8	5	400	66	8	63	1500
CARS-4809(M)	43.2-52.8	9	222	63	8	66	1500
CARS-4812(M)	43.2-52.8	12	167	60	8	69	1500
CARS-4815(M)	43.2-52.8	15	133	60	8	69	1500
CARD-4805(M)	43.2-52.8	+/-5	+/-200	66	8	63	1500
CARD-4812(M)	43.2-52.8	+/-12	+/-84	60	8	69	1500
CARD-4815(M)	43.2-52.8	+/-15	+/-67	66	8	63	1500

Note: Other input to output voltages may be available. Please contact factory.

⁶ CAR*.**** ----- Non-Conductive Plastic CAR*.****M ----- Five-sided shield case

⁷ NOMINAL INPUT VOLTAGE.

⁸ NOMINAL INPUT VOLTAGE, FULL LOAD.

● SIMPLIFIED SCHEMATIC

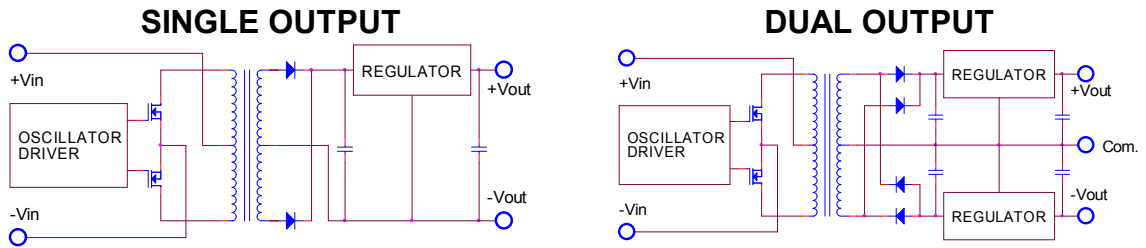

● MECHANICAL DIMENSIONS & RECOMMENDED FOOTPRINT DETAILS

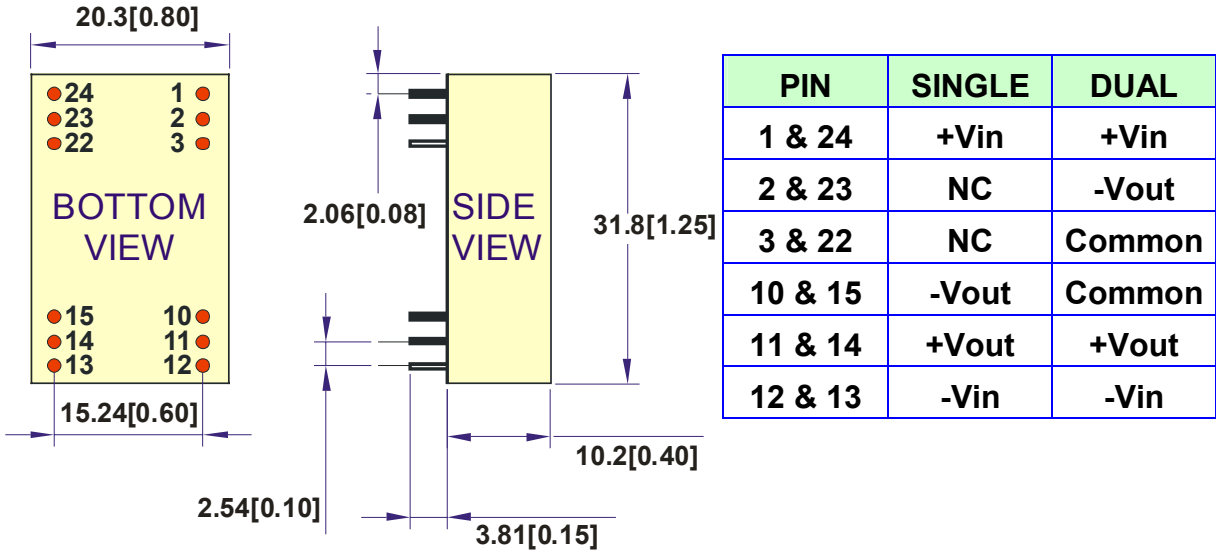

All dimensions are in mm[inches]

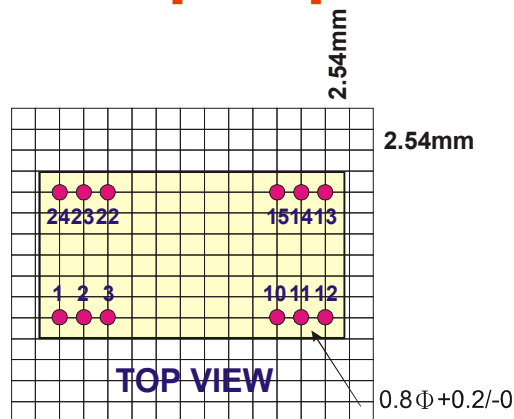

● TYPICAL APPLICATIONS

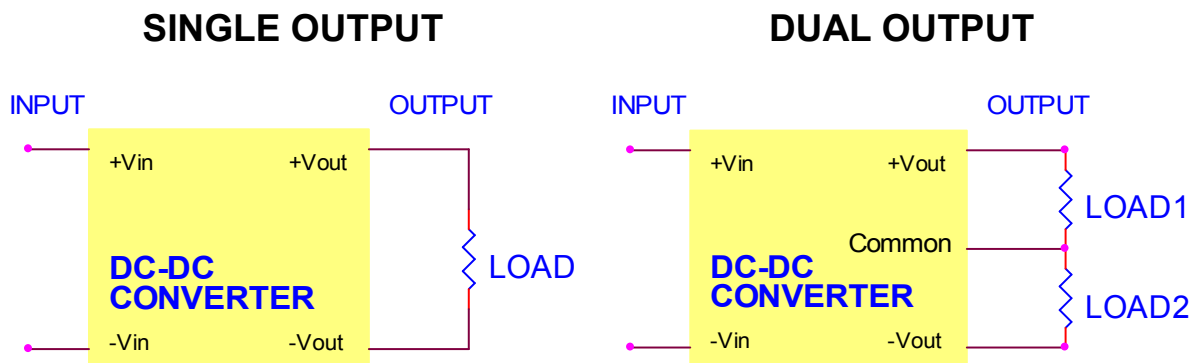

● TYPICAL PERFORMANCE CURVES

Specifications typical at $t_a=25^{\circ}\text{C}$, nominal input voltage, rated output current unless otherwise specified.

OUTPUT LOAD VS EFFICIENCY

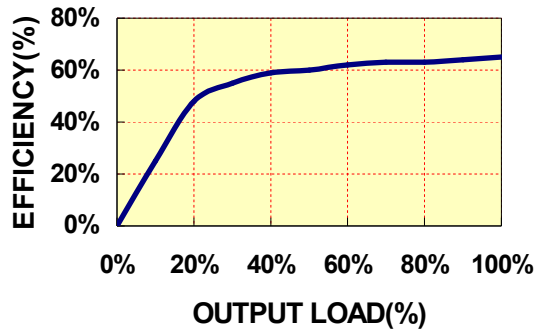

OUTPUT LOAD VS OUTPUT VOLTAGE

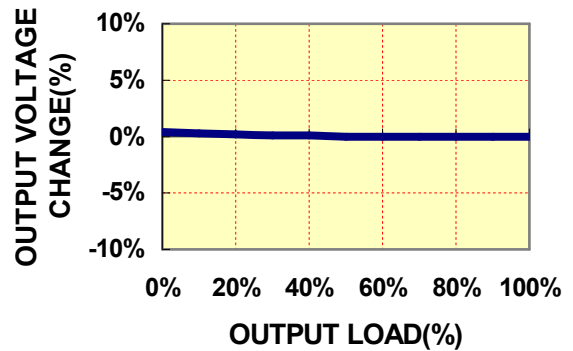

TEMPERATURE DERATING

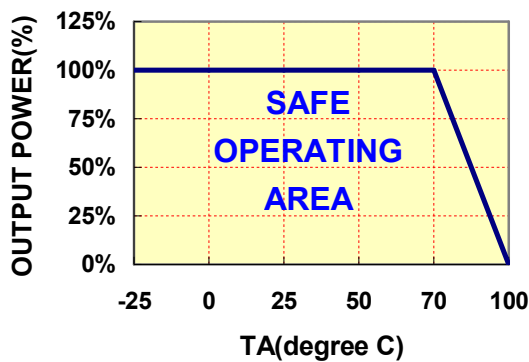

INPUT VOLTAGE VS EFFICIENCY

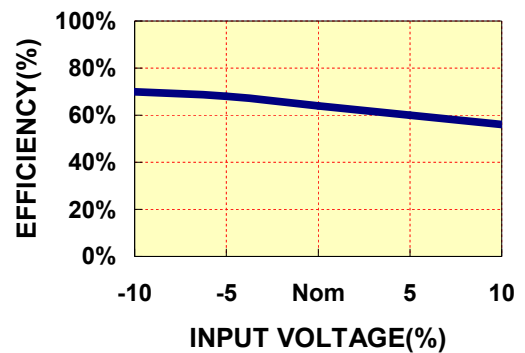

● INPUT FUSE SELECTION GUIDE

4.5-5.5V INPUT VOLTAGE(VDC)	10.8-13.2V INPUT VOLTAGE(VDC)	21.6-30.8V INPUT VOLTAGE(VDC)	43.2-52.8V INPUT VOLTAGE(VDC)
1200mA Slow-Blow Type	400mA Slow-Blow Type	250mA Slow-Blow Type	100mA Slow-Blow Type

Note: Certain applications may require the installation of external fuse in front of the input.

CAR SERIES APPLICATION NOTES:

EXTERNAL CAPACITANCE REQUIREMENTS:

No external capacitance is required for operation of the CAR series.

To meet the reflected ripple requirements of the converter, an input impedance of less than 0.5 ohm from DC to 100KHz is required.

External output capacitance is not required for operation, however it is recommended that 10uF tantalum and 0.1uF ceramic capacitance be selected for reduced system noise.

Additional output capacitance may be added for increased filtering, but should not exceed 220uF.

We Can Offer EMC-Filter According To EN55011/22 Class B.

Negative Outputs:

A negative output voltage may be obtained by connecting the +OUT to circuit ground and connecting -OUT as the negative output.

FOR MORE INFORMATION CALL:

Danube Enterprise Co., Ltd.

Tel: 886-7-3755165

Fax: 886-7-3755330

E-mail: danube@ms10.hinet.net

Home Page

<http://www.danube.com.tw>
