

2103124-5 ✓ ACTIVE

HVA 280

TE Internal #: 2103124-5

PCB Mount Header, Wire-to-Wire, 2 Position, 10.4 mm [.409 in]

Centerline, Fully Shrouded, Sealable, Signal, Orange, HVA 280

[View on TE.com >](#)



Connectors > PCB Connectors > PCB Headers & Receptacles > High-Voltage Header



Connector System: **Wire-to-Wire**

Number of Positions: **2**

Centerline (Pitch): **10.4 mm [.409 in]**

Sealable: **Yes**

Number of Rows: **1**

[All High-Voltage Header \(34\)](#)

## Features

### Product Type Features

Hybrid Header	Yes
Connector Shape	Rectangular
PCB Connector Assembly Type	PCB Mount Header
Header Type	Fully Shrouded
Connector System	Wire-to-Wire
Sealable	Yes

### Configuration Features

Number of Sections	1
Number of Signal Positions	2
Number of Positions	2
Number of Rows	1

### Body Features

Primary Product Color	Orange
Connector & Keying Code	E

### Contact Features

Contact Type	Tab
Mating Tab Width	2.8 mm[.11 in]



Mating Tab Thickness	.8 mm[.031 in]
----------------------	----------------

### Mechanical Attachment

Mounting Holes	Without
----------------	---------

Mating Retention	With
------------------	------

Mating Alignment	With
------------------	------

PCB Mount Alignment	Without
---------------------	---------

Panel Mount Feature	Without
---------------------	---------

PCB Mount Retention	Without
---------------------	---------

Mating Retention Type	Locking Interface
-----------------------	-------------------

### Housing Features

Centerline (Pitch)	10.4 mm[.409 in]
--------------------	------------------

### Dimensions

Connector Length	45.4 mm[1.78 in]
------------------	------------------

Connector Width	40.6 mm[1.59 in]
-----------------	------------------

### Operation/Application

Shielded	Yes
----------	-----

Circuit Application	Signal
---------------------	--------

### Packaging Features

Packaging Type	Package
----------------	---------

Packaging Quantity	1
--------------------	---

### Product Compliance

[For compliance documentation, visit the product page on TE.com>](#)

EU RoHS Directive 2011/65/EU	Compliant
------------------------------	-----------

EU ELV Directive 2000/53/EC	Compliant
-----------------------------	-----------

China RoHS 2 Directive MIIT Order No 32, 2016	No Restricted Materials Above Threshold
---	---

EU REACH Regulation (EC) No. 1907/2006	<p>Current ECHA Candidate List: JUNE 2023 (235)</p> <p>Candidate List Declared Against: JUNE 2023 (235)</p> <p>SVHC &gt; Threshold:</p> <p>Octamethylcyclotetrasiloxane (D4) (.5% in Component Part)</p> <p>Dodecamethylcyclohexasiloxane (D6) (.5% in Component Part)</p>
--	--



Decamethylcyclopentasiloxane (D5) (.5% in Component Part)

**Article Safe Usage Statements:**  
Wash thoroughly after handling. Recycle if possible and dispose of the article by following all applicable governmental regulations relevant to your geographic location.

Halogen Content	Low Halogen - Br, Cl, F, I < 900 ppm per homogenous material. Also BFR/CFR/PVC Free
Solder Process Capability	Not reviewed for solder process capability

Product Compliance Disclaimer

This information is provided based on reasonable inquiry of our suppliers and represents our current actual knowledge based on the information they provided. This information is subject to change. The part numbers that TE has identified as EU RoHS compliant have a maximum concentration of 0.1% by weight in homogenous materials for lead, hexavalent chromium, mercury, PBB, PBDE, DBP, BBP, DEHP, DIBP, and 0.01% for cadmium, or qualify for an exemption to these limits as defined in the Annexes of Directive 2011/65/EU (RoHS2). Finished electrical and electronic equipment products will be CE marked as required by Directive 2011/65/EU. Components may not be CE marked. Additionally, the part numbers that TE has identified as EU ELV compliant have a maximum concentration of 0.1% by weight in homogenous materials for lead, hexavalent chromium, and mercury, and 0.01% for cadmium, or qualify for an exemption to these limits as defined in the Annexes of Directive 2000/53/EC (ELV). Regarding the REACH Regulation, the information TE provides on SVHC in articles for this part number is based on the latest European Chemicals Agency (ECHA) 'Guidance on requirements for substances in articles' posted at this URL: <https://echa.europa.eu/guidance-documents/guidance-on-reach>

### Compatible Parts



TE Part # 4-2103177-5  
PLUG ASSY, KEY E, FA, CPA, HVA280-2PHI XE



TE Part # 1587733-1  
SHIPPING CAP, CAP, HVA280-3PM



TE Part # YHV280-2PM-P-4MM-E  
HVA280-2pnm,pass,4sqmm,Key E



TE Part # YHV280-2PM-S-4MM-E  
HVA280-2pnm,shunted,4sqmm,Key E

### Also in the Series | HVA 280



Automotive Connector Caps & Covers (5)



Automotive Connector EMC Shielding (15)



Automotive Housings(77)



Automotive Seals & Cavity Plugs(8)



Electric, Hybrid & Fuel Cell Cable Assemblies(6)



High Voltage Wire Processing Equipment(7)



Other Automotive Connector Accessories(37)



PCB Headers & Receptacles(37)

## Customers Also Bought



TE Part #2103124-1  
High-Voltage Header



TE Part #1587985-1  
INNER HSG SUBASSY, HVA280-2PHM



TE Part #6-2176088-0  
RP 1J 0.166W 3K65 0.1% 25PPM 1K RL



TE Part #2138839-1  
PLUG ASSY, 28 POS, KEY A, AMPSEAL 16 HL



TE Part #179093-6  
MULTILOCK, CONNECTOR HOUSING

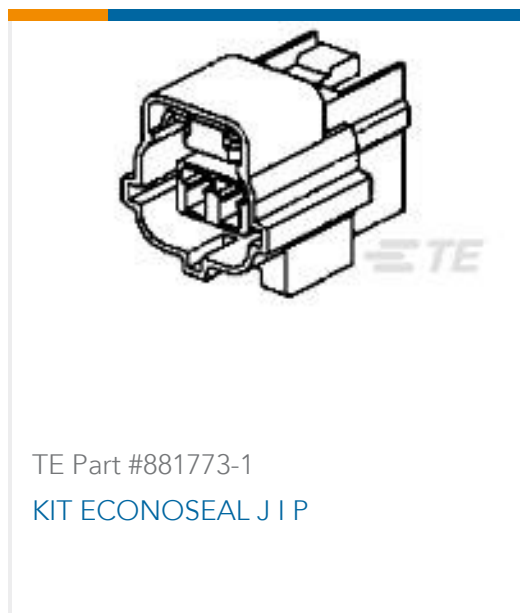

TE Part #881773-1  
KIT ECONOSEAL J I P

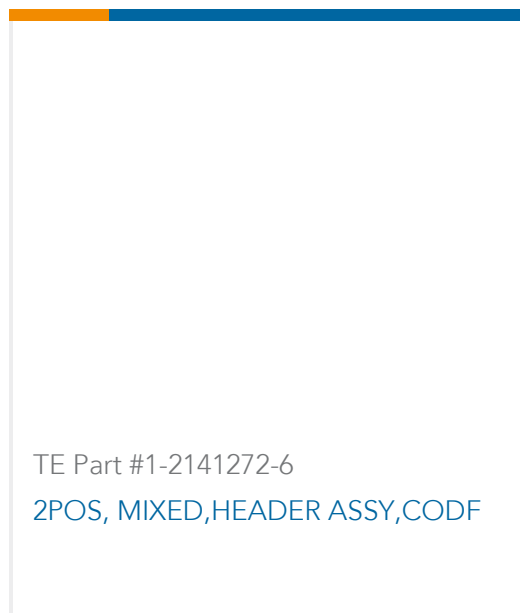

TE Part #1-2141272-6  
2POS, MIXED,HEADER ASSY,CODF

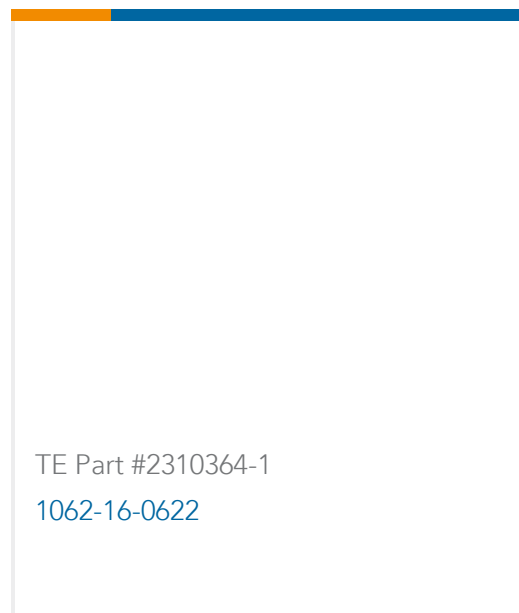

TE Part #2310364-1  
1062-16-0622

## Documents

### Product Drawings

[HVA280 2P HEADER ASSY, KEY E](#)

English

### CAD Files

[3D PDF](#)

3D

Customer View Model

[ENG\\_CVM\\_CVM\\_2103124-5\\_B.2d\\_dxf.zip](#)

English

Customer View Model

[ENG\\_CVM\\_CVM\\_2103124-5\\_B.3d\\_igs.zip](#)

English

Customer View Model

[ENG\\_CVM\\_CVM\\_2103124-5\\_B.3d\\_stp.zip](#)

English

By downloading the CAD file I accept and agree to the [Terms and Conditions](#) of use.



---

**Instruction Sheets**

**Instruction Sheet (U.S.)**

English