

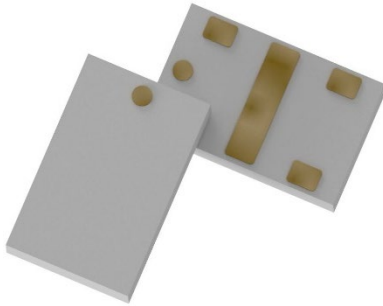

**Ultra Low Profile 0805
2dB 90° Coupler**



Description:

The X4C25J1-02G is a low profile, high performance 2dB 90° coupler in a new easy to use, manufacturing friendly surface mount package. It is designed for 5G applications. The X4C25J1-02G is available on tape and reel for pick and place high volume manufacturing.

All of the Xinger components are constructed from ceramic filled PTFE composites, which possess excellent electrical and mechanical stability. All parts have been subjected to rigorous qualification testing and units are 100% RF tested. Produced in an ENIG final finish.

Features:

- 2200-2800 MHz
- 5G Applications
- Very Low Loss
- Tight Amplitude Balance
- High Isolation
- Production Friendly
- Tape and Reel

Electrical Specifications**

| Frequency | Coupling | Insertion Loss | Return Loss |
|-----------|----------|---------------------|-----------------|
| MHz | dB | dB Max | dB Min |
| 2200-2800 | 2 ± 0.5 | 0.5 | 20 |
| Isolation | Phase | Power | Operating Temp. |
| dB Min | Degrees | Avg. CW Watts @105C | °C |
| 22 | 90 ± 4 | 5 | -55 to +140 |

**Specification based on performance of unit properly installed on TTM Test Board with small signal applied.

*Specifications subject to change without notice. Refer to parameter definitions for details.

Mechanical Outline:

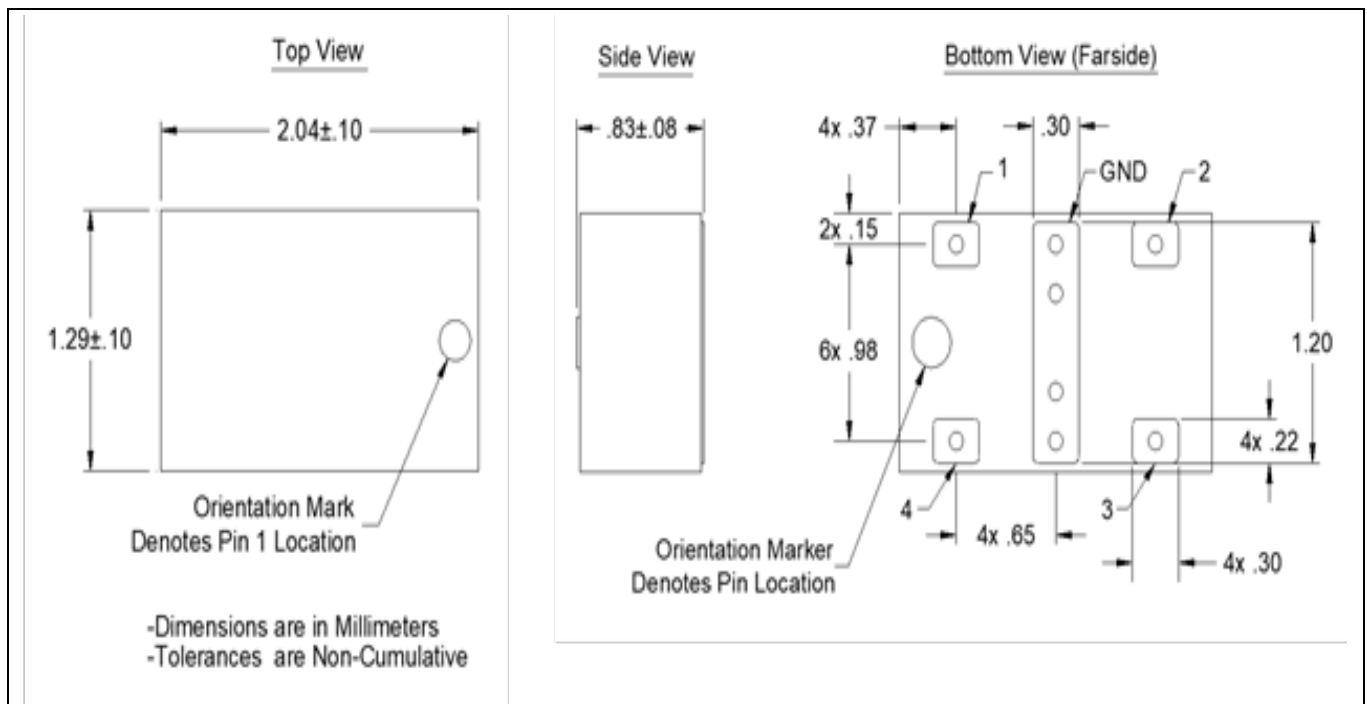

Hybrid Coupler Pin Configuration

The X4C25J1-02G has an orientation marker to denote Pin 1. Once port one has been identified the other ports are known automatically. Please see the chart below for clarification.

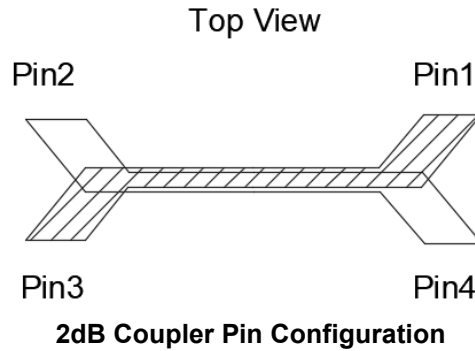

| Configuration | Pin 1 | Pin 2 | Pin 3 | Pin 4 |
|---------------|---------------------|---------------------|---------------------|---------------------|
| Splitter | Input | Isolated | -5dB < Θ -90 | -2dB < Θ |
| Splitter | Isolated | Input | -2dB < Θ | -5dB < Θ -90 |
| Splitter | -5dB < Θ -90 | -2dB < Θ | Input | Isolated |
| Splitter | -2dB < Θ | -5dB < Θ -90 | Isolated | Input |

Note: The direct port has a DC connection to the input port and the coupled port has a DC connection to the isolated port. For optimum IL and power handling performance, use Pin 1 or Pin 3 as inputs.

Insertion Loss and Power Derating Curves

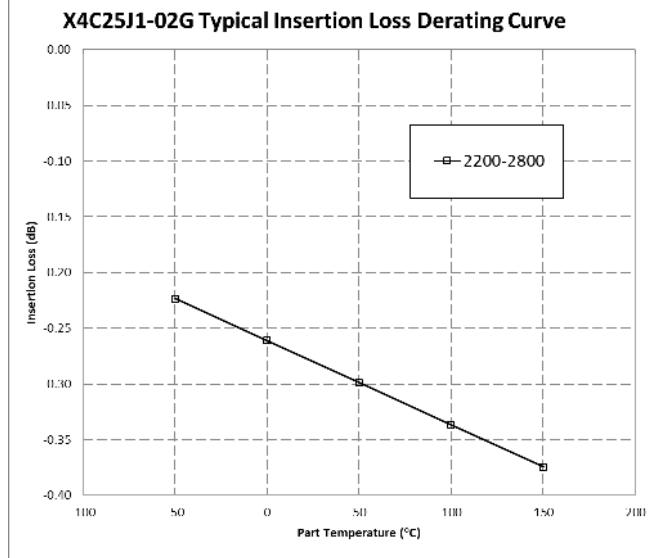

Insertion Loss Derating

The insertion loss, at a given frequency, of a group of couplers is measured at 25°C and then averaged. The measurements are performed under small signal conditions (i.e. using a Vector Network Analyzer). The process is repeated at -55°C, 105°C and 140°C. A best-fit line for the measured data is computed and then plotted from -55°C to 140°C.

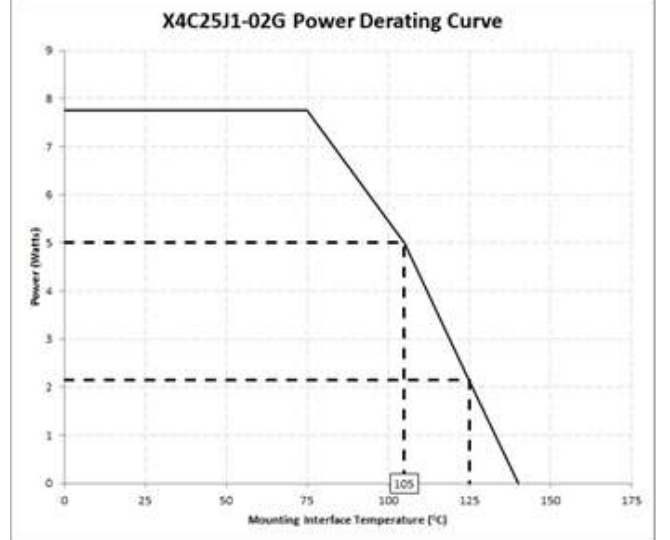

Power Derating

The power handling and corresponding power derating plots are a function of the thermal resistance, mounting surface temperature (base plate temperature), maximum continuous operating temperature of the coupler, and the thermal insertion loss. The thermal insertion loss is defined in the Power Handling section of the data sheet.

As the mounting interface temperature approaches the maximum continuous operating temperature, the power handling decreases to zero.

If mounting temperature is greater than 105°C, Xinger coupler will perform reliably as long as the input power is derated to the curve above.

Typical Performance 2200 MHz to 2800 MHz (Configuration 1)

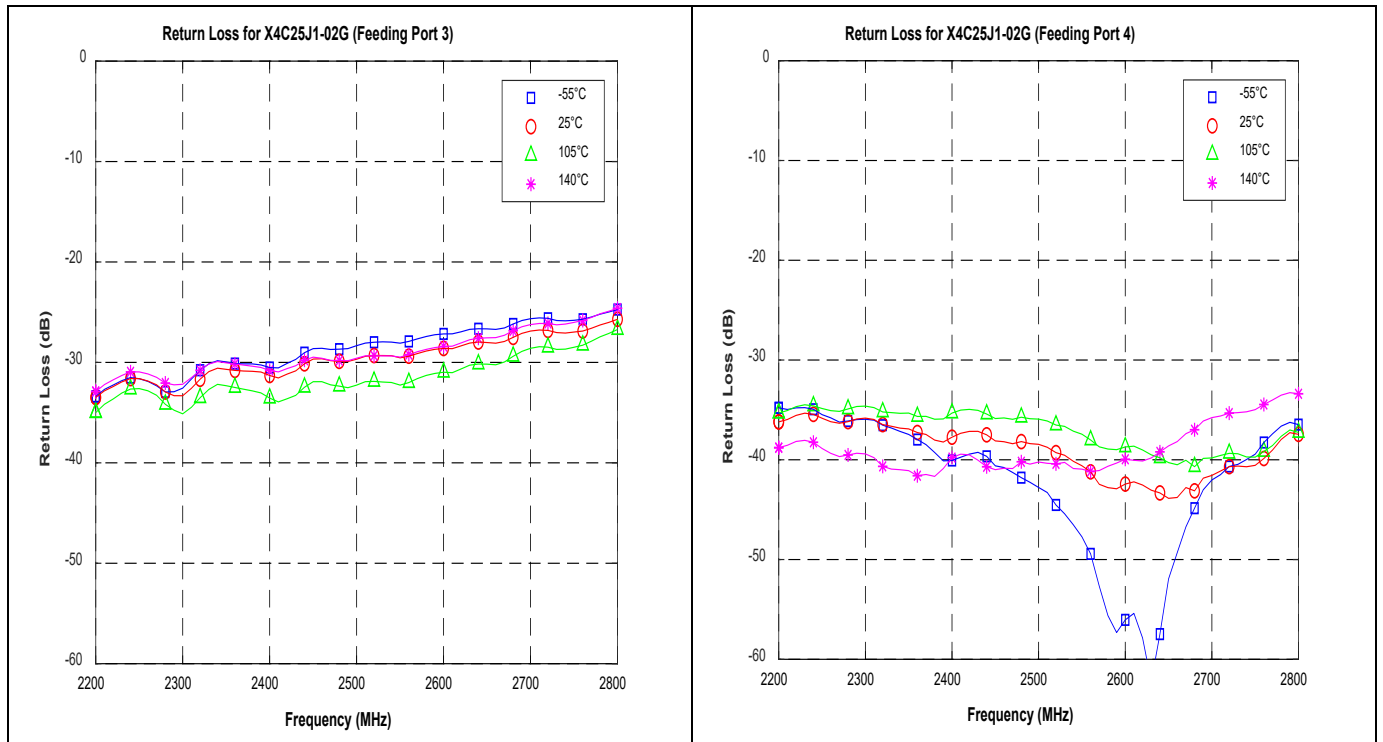
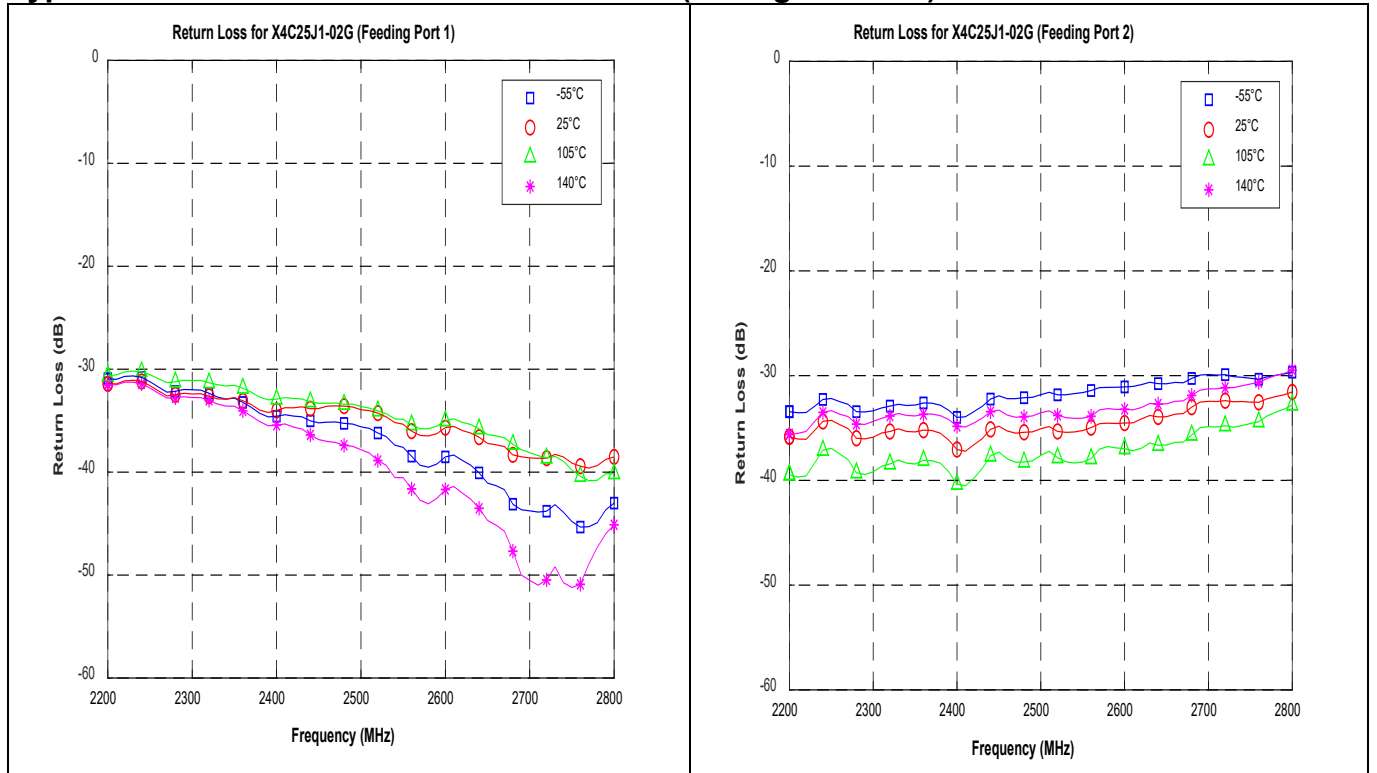

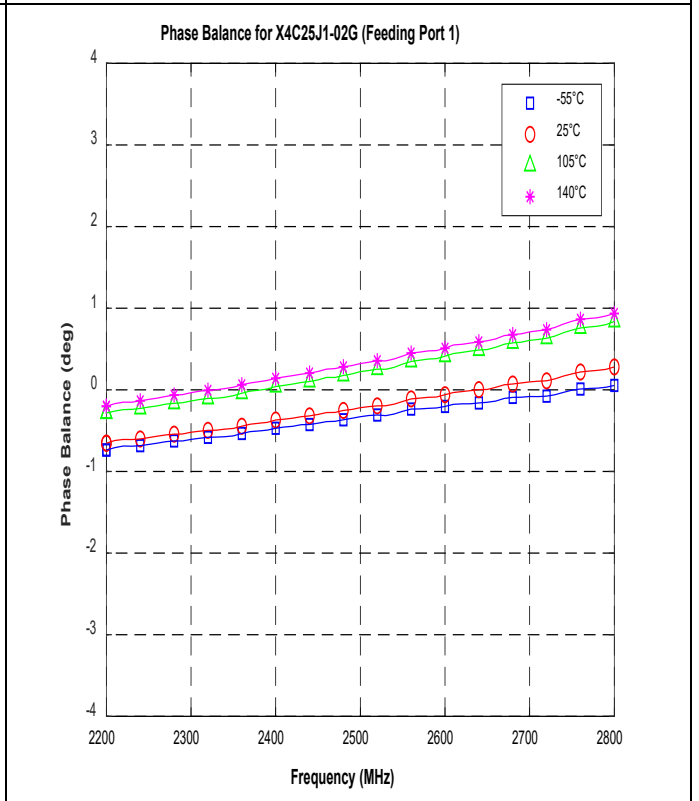
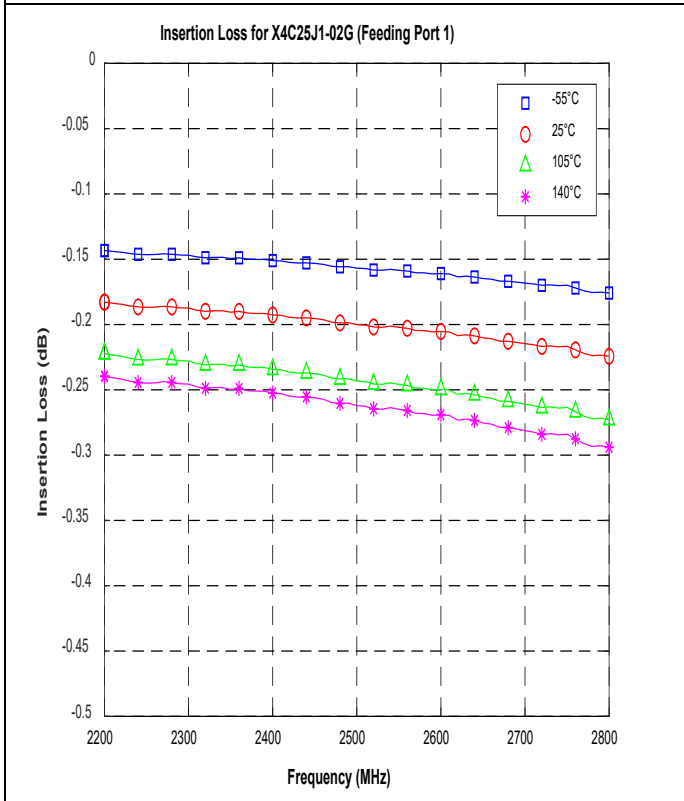
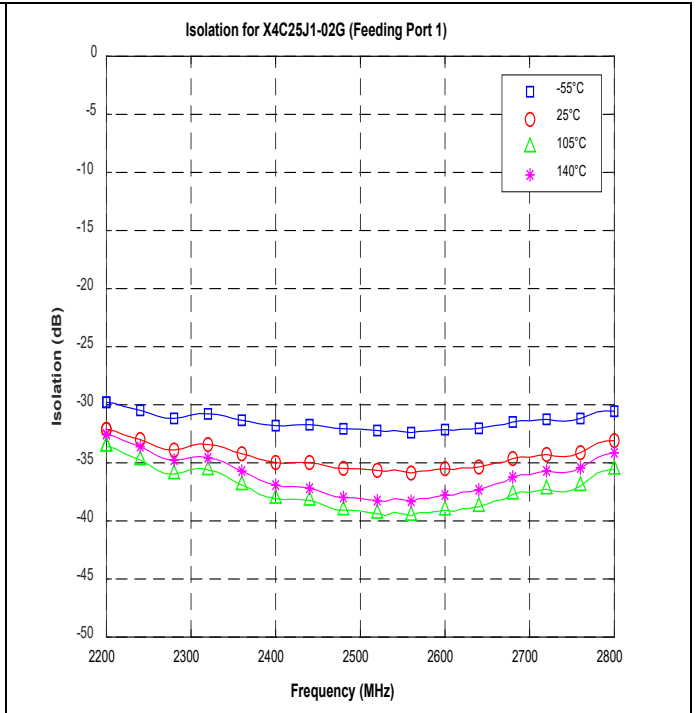
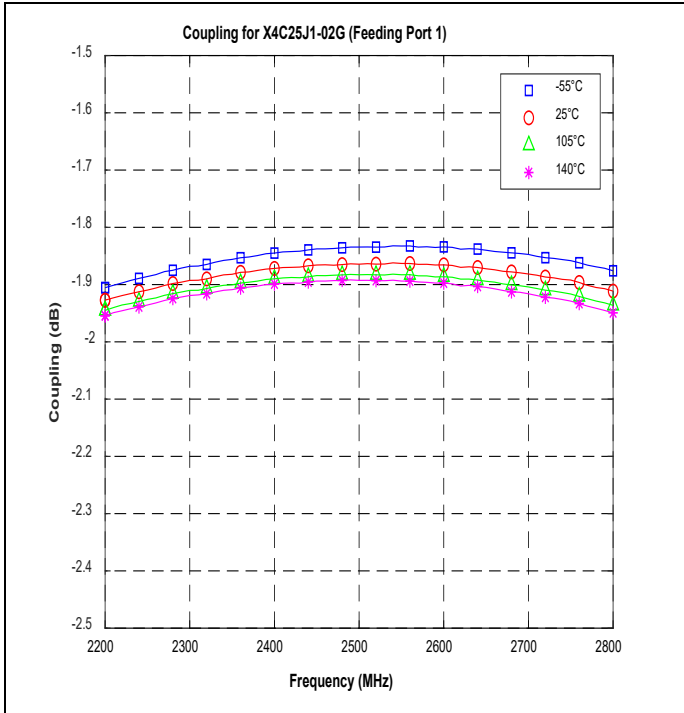

Definition of Measured Specification

| Parameter | Definition | Mathematical Representation |
|----------------------------------------------|------------------------------------------------------------------------------------------------------------|-----------------------------------------------------------------------------------------------------------------------|
| VSWR (Voltage Standing Wave Ratio) | The impedance match of the coupler to a 50Ω system. A VSWR of 1:1 is optimal. | $VSWR = \frac{V_{max}}{V_{min}}$ Vmax = voltage maxima of a standing wave Vmin = voltage minima of a standing wave |
| Return Loss | The impedance match of the coupler to a 50Ω system. Return Loss is an alternate means to express VSWR. | $Return\ Loss(dB) = 20\log \frac{VSWR + 1}{VSWR - 1}$ |
| Insertion Loss | The input power divided by the sum of the power at the two output ports. | $Insertion\ Loss(dB) = 10\log \frac{P_{in}}{P_{cpl} + P_{direct}}$ |
| Isolation | The input power divided by the power at the isolated port. | $Isolation(dB) = 10\log \frac{P_{in}}{P_{iso}}$ |
| Phase Balance | The difference in phase angle between the two output ports. | Phase at coupled port - Phase at direct port |
| Coupling | At a given frequency (ω_n), coupling is the input power divided by the power at the coupled port. | $Coupling(dB) = C(\omega_n) = 10\log \frac{P_{in}(\omega_n)}{P_{cpl}(\omega_n)}$ |
| Group Delay | Group delay is average of group delay's from input port to the coupled port | Average (GD-C) |

Packaging and Ordering Information:

Parts are available in reel and are packaged per EIA 481-D. Parts are oriented in tape and reel as shown below. Minimum order quantities are 4000 per reel.

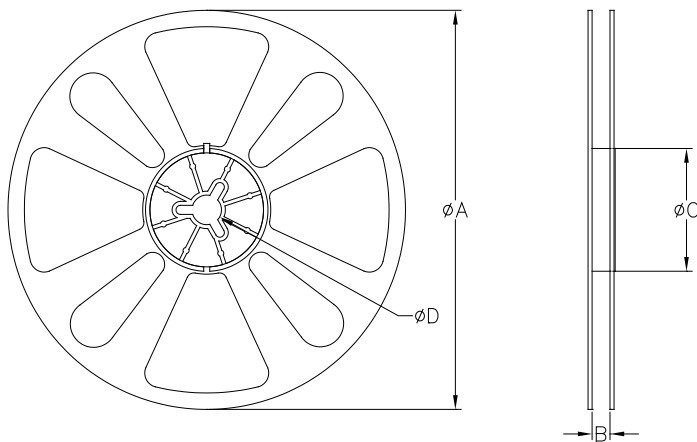
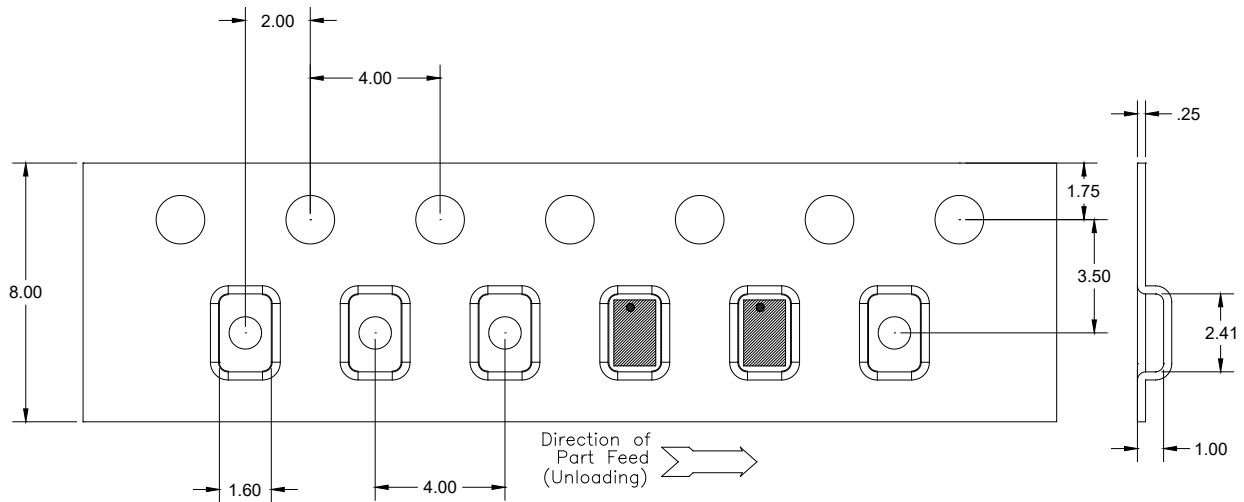

| TABLE 1 | | |
|---------------|--------------------|--------|
| QUANTITY/REEL | REEL DIMENSIONS mm | |
| 4000 | ϕA | 177.80 |
| | B | 8.00 |
| | ϕC | 50.80 |
| | ϕD | 13.00 |

Contact us:
rf&s_support@ttm.com