

# Ceramic Low Pass Filter

## LFCW-103+

50Ω DC to 10 GHz



Generic photo used for illustration purposes only  
CASE STYLE: JC0603C-1

### The Big Deal

- Very good rejection, 40 dB typical
- Rugged, ceramic construction
- Tiny size, 0.063 x 0.032 x 0.024" (0603)
- Good power handling, 2.5W

### Product Overview

Mini-Circuits' LFCW-103+ is an LTCC low pass filter with a passband from DC to 10 GHz, supporting a variety of applications. This model provides 1.5 dB typical passband insertion loss and provides a very good stopband rejection due to strategically constructed layout with minimal interaction between components. It handles up to 2.5W RF input power and provides a wide operating temperature range from -55 to +125°C. Housed in a tiny 0603 ceramic form factor with wraparound terminations, the filter is ideal for dense PCB layouts and with minimal performance variation due to parasitics.

### Key Features

Feature	Advantages
Ultra-wide stopband	The LTCC lowpass filter provides a very good stopband rejection until 26.5 GHz suitable for high end applications.
LTCC Construction	Provides repeatable performance in a rugged, ceramic package well suited for tough environments such as high humidity and temperature extremes.
Tiny size ( 0.063 x 0.032 x 0.024")	Saves space in dense circuit board layouts and minimizes the effects of parasitics.
Good power handling, 2.5W	Supports a wide range of system power requirements.
Wrap-around terminations	Provides excellent solderability and easy visual inspection

#### Notes

- A. Performance and quality attributes and conditions not expressly stated in this specification document are intended to be excluded and do not form a part of this specification document.  
B. Electrical specifications and performance data contained in this specification document are based on Mini-Circuit's applicable established test performance criteria and measurement instructions.  
C. The parts covered by this specification document are subject to Mini-Circuits standard limited warranty and terms and conditions (collectively, "Standard Terms"); Purchasers of this part are entitled to the rights and benefits contained therein. For a full statement of the Standard Terms and the exclusive rights and remedies thereunder, please visit Mini-Circuits' website at [www.minicircuits.com/MCLStore/terms.jsp](http://www.minicircuits.com/MCLStore/terms.jsp)



# Low Pass Filter

## LFCW-103+

50Ω DC to 10 GHz



Generic photo used for illustration purposes only  
CASE STYLE: JC0603C-1

**+RoHS Compliant**  
The +Suffix identifies RoHS Compliance. See our web site for RoHS Compliance methodologies and qualifications

### Features

- Low loss, 1.5 dB typical
- Good rejection 40 dB typical
- Extremely small size 0603 (0.063 X 0.032 X 0.024")
- Temperature stable
- LTCC construction

### Applications

- Test and measurements
- Telecommunications and broadband wireless system
- Military applications
- Satcom modems

### Electrical Specifications<sup>1,2</sup> at 25°C

Parameter	F#	Frequency (MHz)	Min.	Typ.	Max.	Unit	
Pass Band	Insertion Loss	DC-F1	DC - 10000	—	1.5	2.3	dB
	Freq. Cut-Off	F2*	11400	—	3.0	—	dB
	Return Loss	DC-F1	DC - 10000	—	13	—	dB
Stop Band	Rejection Loss	F3-F4	13700 - 15000	20	40	—	dB
		F4-F5	15000 - 18000	30	38	—	dB
		F5-F6	18000 - 23000	25	34	—	dB
		F6-F7	23000 - 26500	—	15	—	dB

1 In Applications where DC voltage and/or current is present at either input or output ports, DC de-coupling capacitors are required. If DC pass from IN-OUT is required, please contact Mini-Circuits for alternatives.  
2 Measured on Mini-Circuits Characterization Test Board TB-LFCW-103+

\* Typically, a ±5% frequency deviation from the stated value may occur on a unit-to-unit basis.

### Functional Schematic

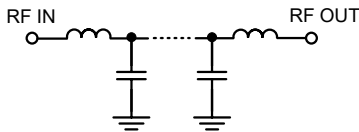

### Maximum Ratings

Operating Temperature	-55°C to 125°C
Storage Temperature	-55°C to 125°C
RF Power Input*	2.5 W @25°C

\*Passband rating, derate linearly to 0.7 W at 125°C ambient  
Permanent damage may occur if any of these limits are exceeded.

### Typical Performance Data at 25°C

Frequency (MHz)	Insertion Loss (dB)	Return Loss (dB)
10	0.06	59.75
100	0.06	38.53
1000	0.01	26.45
2000	0.04	24.38
3000	0.06	21.25
5000	0.19	17.31
10000	0.98	14.68
11400	2.56	9.00
11560	3.06	8.04
12000	6.44	4.18
12580	20.72	0.90
12900	30.83	0.64
13700	55.86	0.43
14000	51.71	0.38
15000	49.24	0.29
18000	44.54	0.25
20000	39.62	0.17
23000	36.74	0.07
25000	43.72	0.35
26500	22.89	0.41

### Typical Frequency Response

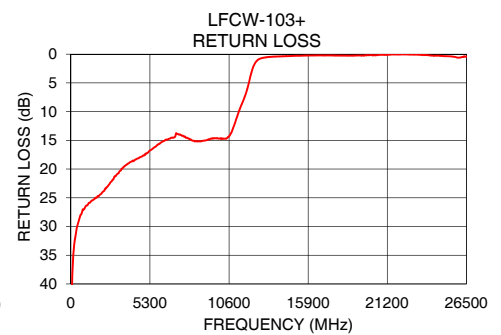
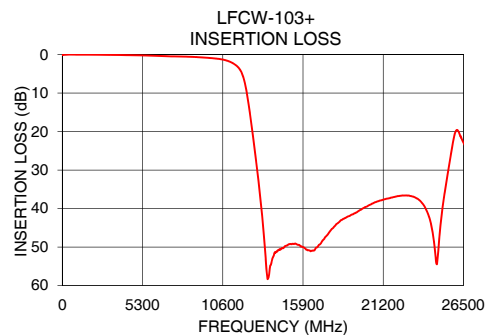
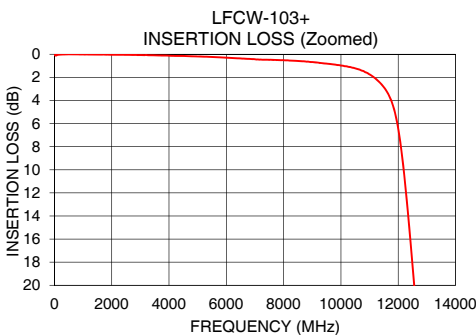
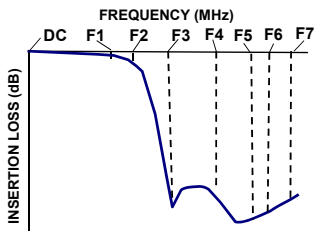

### Notes

- Performance and quality attributes and conditions not expressly stated in this specification document are intended to be excluded and do not form a part of this specification document.
- Electrical specifications and performance data contained in this specification document are based on Mini-Circuit's applicable established test performance criteria and measurement instructions.
- The parts covered by this specification document are subject to Mini-Circuits standard limited warranty and terms and conditions (collectively, "Standard Terms"); Purchasers of this part are entitled to the rights and benefits contained therein. For a full statement of the Standard Terms and the exclusive rights and remedies thereunder, please visit Mini-Circuits' website at [www.minicircuits.com/MCLStore/terms.jsp](http://www.minicircuits.com/MCLStore/terms.jsp)



## Pad Connections

INPUT	1
OUTPUT	3
GROUND	2, 4

Product Marking: H

Demo Board MCL P/N: TB-LFCW-103+  
Suggested PCB Layout (PL-650)

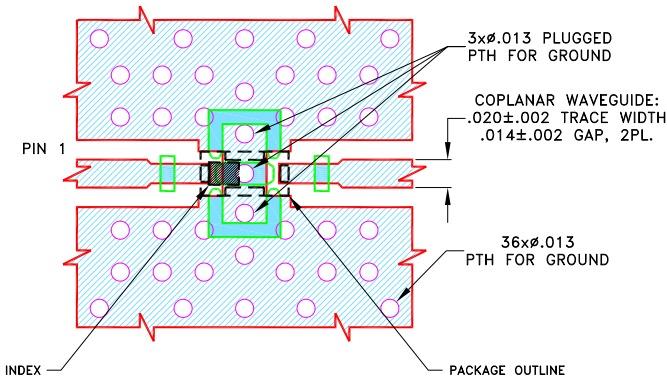

### NOTES:

- COPLANAR WAVEGUIDE PARAMETERS ARE SHOWN FOR ROGERS (R04835 Lo Pro) WITH DIELECTRIC THICKNESS .0107 $\pm$ .0010. COPPER: 1/2 Oz. EACH SIDE.  
FOR OTHER MATERIALS TRACE WIDTH AND GAP MAY NEED TO BE MODIFIED.
  - BOTTOM SIDE OF THE PCB IS CONTINUOUS GROUND PLANE.
- DENOTES PCB COPPER LAYOUT WITH SMOBC (SOLDER MASK OVER BARE COPPER)
- DENOTES COPPER LAND PATTERN FREE OF SOLDERMASK

## Outline Drawing

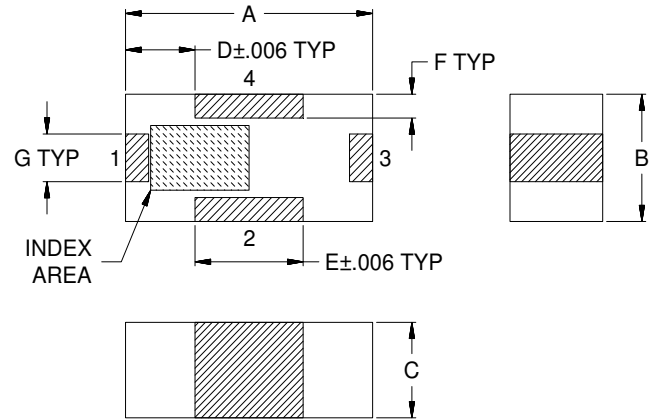

## Outline Dimensions (Inch / mm)

A	B	C	D	E	F	G	Wt.
.063	.032	.024	.018	.028	.006	.012	grams
1.60	0.80	0.60	0.45	0.70	0.15	0.30	.005

Note: Please refer to case style drawing for details

### Notes

- A. Performance and quality attributes and conditions not expressly stated in this specification document are intended to be excluded and do not form a part of this specification document.
- B. Electrical specifications and performance data contained in this specification document are based on Mini-Circuits' applicable established test performance criteria and measurement instructions.
- C. The parts covered by this specification document are subject to Mini-Circuits' standard limited warranty and terms and conditions (collectively, "Standard Terms"); Purchasers of this part are entitled to the rights and benefits contained therein. For a full statement of the Standard Terms and the exclusive rights and remedies thereunder, please visit Mini-Circuits' website at [www.minicircuits.com/MCLStore/terms.jsp](http://www.minicircuits.com/MCLStore/terms.jsp)