



RF LDMOS Wideband Integrated Power Amplifier

The MW6IC1940GNB wideband integrated circuit is designed with on-chip matching that makes it usable from 1920 to 2000 MHz. This multi-stage structure is rated for 26 to 32 Volt operation and covers all typical cellular base station modulation formats.

Final Application

- Typical 2-Carrier W-CDMA Performance: $V_{DD} = 28$ Volts, $I_{DQ1} = 200$ mA, $I_{DQ2} = 440$ mA, $P_{out} = 4.5$ Watts Avg., $f = 1922.5$ MHz, Channel Bandwidth = 3.84 MHz, PAR = 8.5 dB @ 0.01% Probability on CCDF.
 - Power Gain — 28.5 dB
 - Power Added Efficiency — 13.5%
 - IM3 @ 10 MHz Offset — -43 dBc in 3.84 MHz Bandwidth
 - ACPR @ 5 MHz Offset — -46 dBc in 3.84 MHz Bandwidth

Driver Applications

- Typical 2-Carrier W-CDMA Performance: $V_{DD} = 28$ Volts, $I_{DQ1} = 200$ mA, $I_{DQ2} = 350$ mA, $P_{out} = 26$ dBm, Full Frequency Band (1920-2000 MHz), Channel Bandwidth = 3.84 MHz, PAR = 8.5 dB @ 0.01% Probability on CCDF.
 - Power Gain — 27 dB
 - IM3 @ 10 MHz Offset — -59 dBc in 3.84 MHz Bandwidth
 - ACPR @ 5 MHz Offset — -62 dBc in 3.84 MHz Bandwidth
- Capable of Handling 3:1 VSWR, @ 28 Vdc, 1960 MHz, 40 Watts CW Output Power
- Stable into a 3:1 VSWR. All Spurs Below -60 dBc @ 100 mW to 20 W CW P_{out} .

Features

- Characterized with Series Equivalent Large-Signal Impedance Parameters and Common Source Scattering Parameters
- On-Chip Matching (50 Ohm Input, DC Blocked, >3 Ohm Output)
- Integrated Quiescent Current Temperature Compensation with Enable/Disable Function (1)
- Integrated ESD Protection
- 225°C Capable Plastic Package
- Designed for Lower Memory Effects and Wide Instantaneous Bandwidth Applications
- RoHS Compliant
- In Tape and Reel. R1 Suffix = 500 Units per 44 mm, 13 inch Reel.

MW6IC1940GNBR1

**1920-2000 MHz, 40 W, 28 V
2 x W-CDMA
RF LDMOS WIDEBAND
INTEGRATED POWER AMPLIFIER**

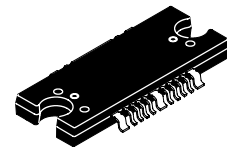

**CASE 1329A-04
TO-272 WB-16 GULL
PLASTIC**

ARCHIVE INFORMATION

ARCHIVE INFORMATION

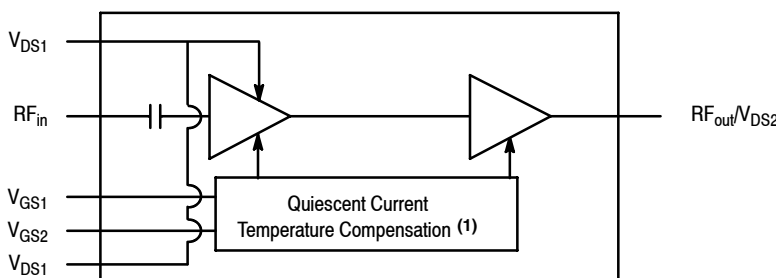
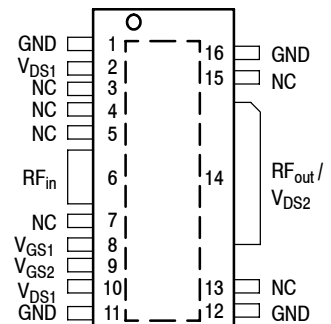

Figure 1. Functional Block Diagram



(Top View)

Note: Exposed backside of the package is the source terminal for the transistors.

Figure 2. Pin Connections

1. Refer to AN1977, *Quiescent Current Thermal Tracking Circuit in the RF Integrated Circuit Family* and to AN1987, *Quiescent Current Control for the RF Integrated Circuit Device Family*. Go to <http://www.freescale.com/rf>. Select Documentation/Application Notes - AN1977 or AN1987.

Table 1. Maximum Ratings

Rating	Symbol	Value	Unit
Drain-Source Voltage	V_{DSS}	-0.5, +68	Vdc
Gate-Source Voltage	V_{GS}	-0.5, +6	Vdc
Storage Temperature Range	T_{stg}	-65 to +150	°C
Case Operating Temperature	T_C	150	°C
Operating Junction Temperature (1,2)	T_J	225	°C
Input Power	P_{in}	20	dBm

Table 2. Thermal Characteristics

Characteristic	Symbol	Value (2,3)	Unit
Thermal Resistance, Junction to Case W-CDMA Application ($P_{out} = 4.5$ W Avg.)	$R_{\theta JC}$	Stage 1, 28 Vdc, $I_{DQ1} = 200$ mA Stage 2, 28 Vdc, $I_{DQ2} = 440$ mA	°C/W
		2.1	
		1.2	

Table 3. ESD Protection Characteristics

Test Methodology	Class
Human Body Model (per JESD22-A114)	1B (Minimum)
Machine Model (per EIA/JESD22-A115)	A (Minimum)
Charge Device Model (per JESD22-C101)	IV (Minimum)

Table 4. Moisture Sensitivity Level

Test Methodology	Rating	Package Peak Temperature	Unit
Per JESD 22-A113, IPC/JEDEC J-STD-020	3	260	°C

Table 5. Electrical Characteristics ($T_A = 25^\circ\text{C}$ unless otherwise noted)

Characteristic	Symbol	Min	Typ	Max	Unit
Power Gain	G_{ps}	26	28.5	31.5	dB
Power Added Efficiency	PAE	12.5	13.5	—	%
Intermodulation Distortion	IM3	—	-43	-40	dBc
Adjacent Channel Power Ratio	ACPR	—	-46	-43	dBc
Input Return Loss	IRL	—	-15	-10	dB

Functional Tests (In Freescale Wideband 1920-2000 MHz Test Fixture, 50 ohm system) $V_{DD} = 28$ Vdc, $I_{DQ1} = 200$ mA, $I_{DQ2} = 440$ mA, $P_{out} = 4.5$ W Avg., $f_1 = 1922.5$ MHz, $f_2 = 1932.5$ MHz, 2-Carrier W-CDMA, 3.84 MHz Channel Bandwidth @ ± 5 MHz Offset. IM3 measured in 3.84 MHz Channel Bandwidth @ ± 10 MHz Offset. PAR = 8.5 dB @ 0.01% Probability on CCDF.

1. Continuous use at maximum temperature will affect MTTF.
2. MTTF calculator available at <http://www.freescale.com/rtf>. Select Software & Tools/Development Tools/Calculators to access MTTF calculators by product.
3. Refer to AN1955, *Thermal Measurement Methodology of RF Power Amplifiers*. Go to <http://www.freescale.com/rtf>. Select Documentation/Application Notes - AN1955.

(continued)

Table 5. Electrical Characteristics ($T_A = 25^\circ\text{C}$ unless otherwise noted) (continued)

Characteristic	Symbol	Min	Typ	Max	Unit
Typical Performances (In Freescale Test Fixture, 50 ohm system) $V_{DD} = 28\text{ Vdc}$, $I_{DQ1} = 210\text{ mA}$, $I_{DQ2} = 370\text{ mA}$, 1920-2000 MHz					
Video Bandwidth @ 40 W PEP P_{out} where $IM3 = -30\text{ dBc}$ (Tone Spacing from 100 kHz to VBW) $\Delta IMD3 = IMD3 @\text{ VBW}$ frequency - $IMD3 @\text{ 100 kHz} < 1\text{ dBc}$ (both sidebands)	VBW	—	30	—	MHz
Quiescent Current Accuracy over Temperature with 18 k Ω Gate Feed Resistors (-10 to 85°C) (1)	ΔI_{QT}	—	± 5	—	%
Gain Flatness in 30 MHz Bandwidth @ $P_{out} = 1\text{ W CW}$	G_F	—	0.75	—	dB
Average Deviation from Linear Phase in 30 MHz Bandwidth @ $P_{out} = 1\text{ W CW}$	Φ	—	± 1	—	°
Average Group Delay @ $P_{out} = 1\text{ W CW}$ Including Output Matching	Delay	—	2.5	—	ns
Part-to-Part Insertion Phase Variation @ $P_{out} = 1\text{ W CW}$, Six Sigma Window	$\Delta\Phi$	—	± 10	—	°

Typical Performances (In Freescale Test Fixture, 50 ohm system) $V_{DD} = 28\text{ Vdc}$, $I_{DQ1} = 240\text{ mA}$, $I_{DQ2} = 440\text{ mA}$, 1920-2000 MHz

Saturated Pulsed Output Power (12 $\mu\text{sec}(on)$, 1% Duty Cycle)	P_{sat}	—	60	—	W
---	-----------	---	----	---	---

1. Refer to AN1977, *Quiescent Current Thermal Tracking Circuit in the RF Integrated Circuit Family* and to AN1987, *Quiescent Current Control for the RF Integrated Circuit Device Family*. Go to <http://www.freescale.com/rf>. Select Documentation/Application Notes - AN1977 or AN1987.

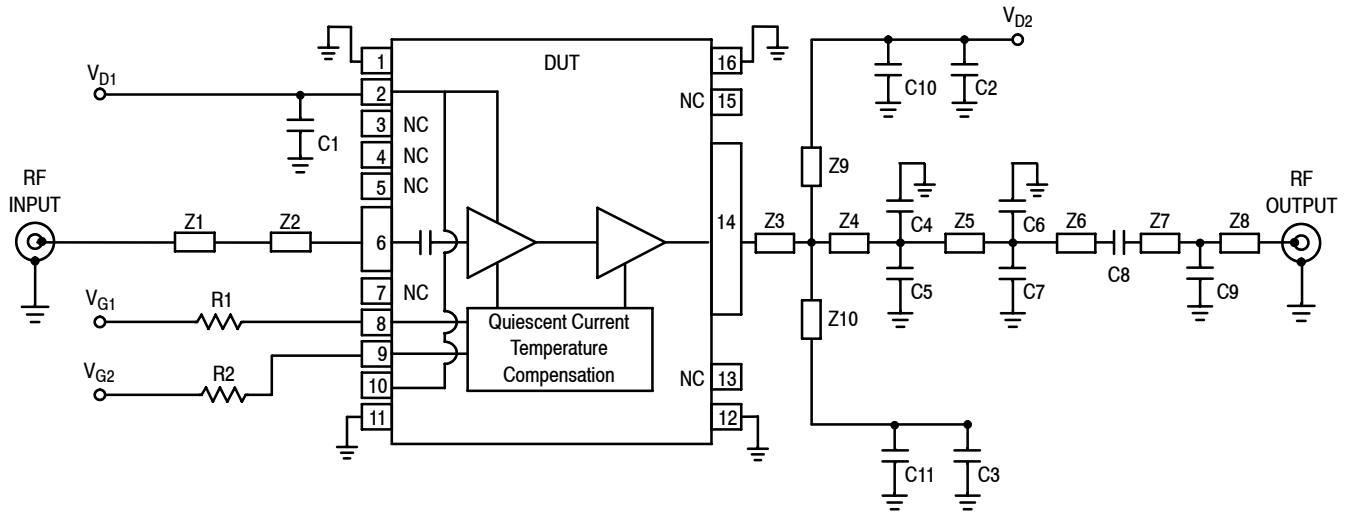

Z1	2.20" x 0.09" Microstrip	Z7*	0.98" x 0.082" Microstrip
Z2	0.13" x 0.04" Microstrip	Z8*	0.76" x 0.082" Microstrip
Z3	0.17" x 0.41" Microstrip	Z9, Z10	0.08" x 0.079" Microstrip
Z4*	0.20" x 0.41" Microstrip	PCB	Taconic TLX8-0300, 0.030", $\epsilon_r = 2.55$
Z5*	0.11" x 0.41" Microstrip		
Z6*	0.06" x 0.41" Microstrip		

* Variable for tuning

Figure 3. MW6IC1940GNBR1 Test Circuit Schematic

Table 6. MW6IC1940GNBR1 Test Circuit Component Designations and Values

Part	Description	Part Number	Manufacturer
C1, C2, C3	2.2 μ F Chip Capacitors	C3225X5R1H225MT	TDK
C4, C5, C6, C7	0.5 pF Chip Capacitors	ATC100B0R5BT500XT	ATC
C8	1.5 pF Chip Capacitor	ATC100B1R5BT500XT	ATC
C9	0.2 pF Chip Capacitor	ATC100B0R2BT500XT	ATC
C10, C11	10 pF Chip Capacitors	ATC100B100JT500XT	ATC
R1	4.7 k Ω , 1/4 W Chip Resistor	CRCW12064701FKEA	Vishay
R2	3.3 k Ω , 1/4 W Chip Resistor	CRCW12063301FKEA	Vishay

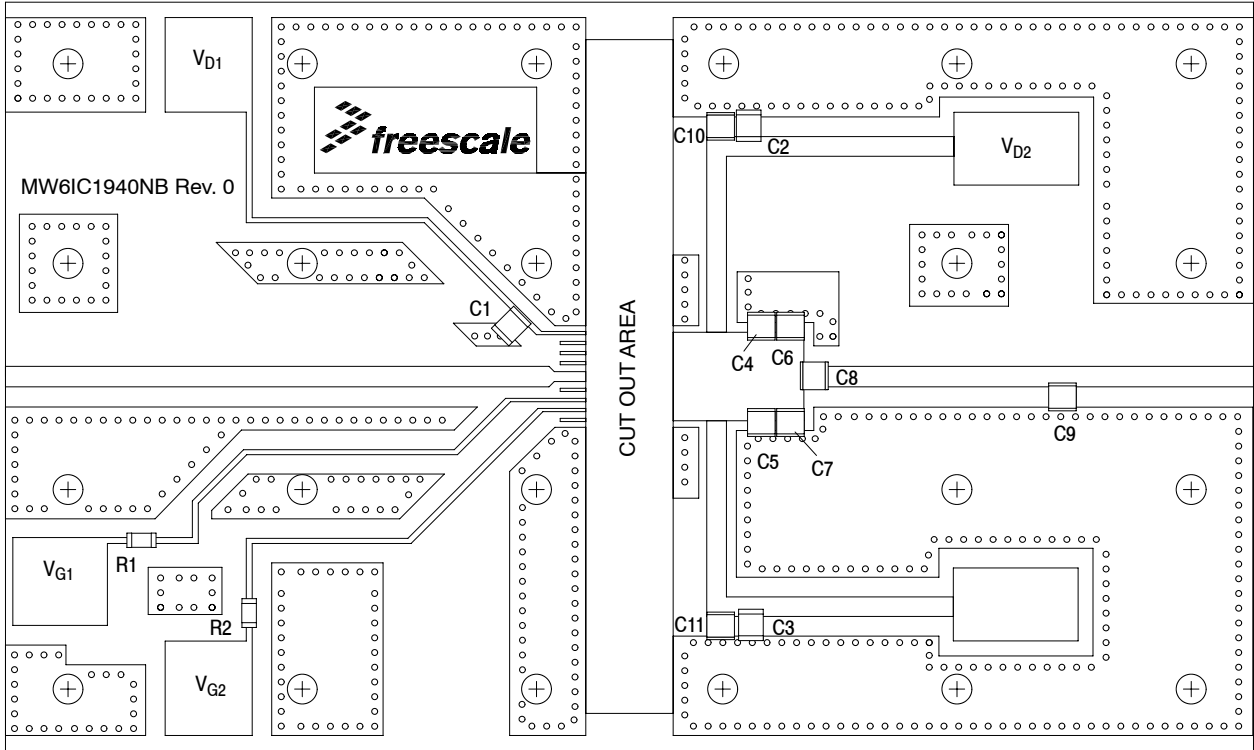

Figure 4. MW6IC1940GNBR1 Test Circuit Component Layout

TYPICAL CHARACTERISTICS

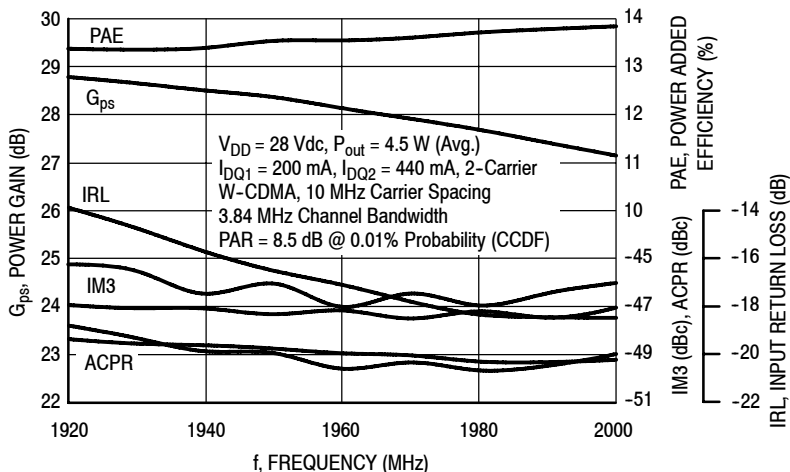

Figure 5. 2-Carrier W-CDMA Wideband Performance @ $P_{out} = 4.5$ Watts Avg.

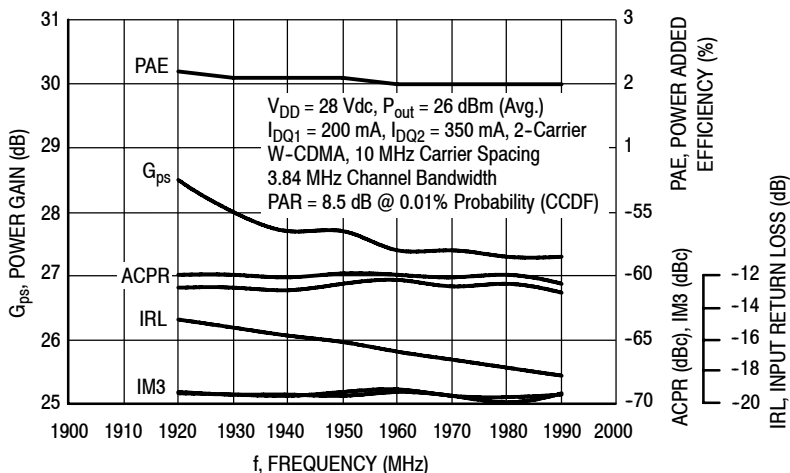

Figure 6. 2-Carrier W-CDMA Wideband Performance @ $P_{out} = 26$ dBm Avg.

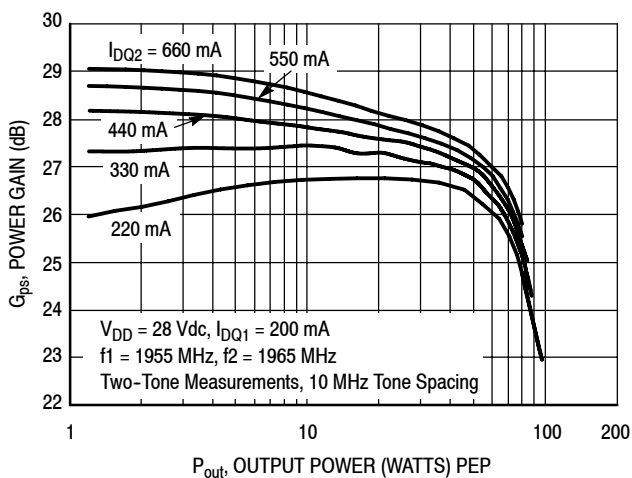

Figure 7. Two-Tone Power Gain versus Output Power @ $I_{DQ1} = 200$ mA

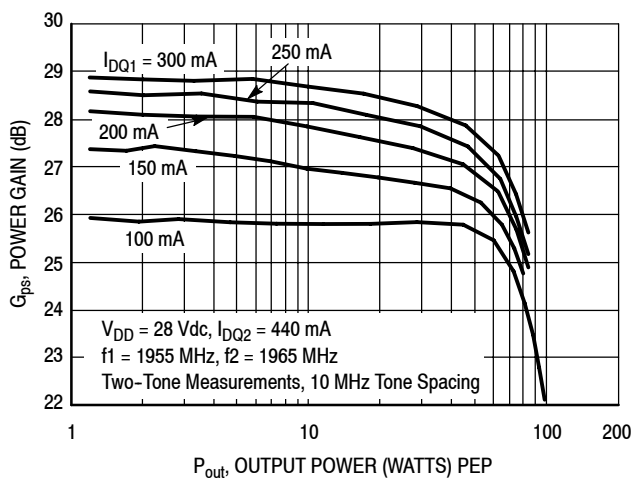

Figure 8. Two-Tone Power Gain versus Output Power @ $I_{DQ2} = 440$ mA

TYPICAL CHARACTERISTICS

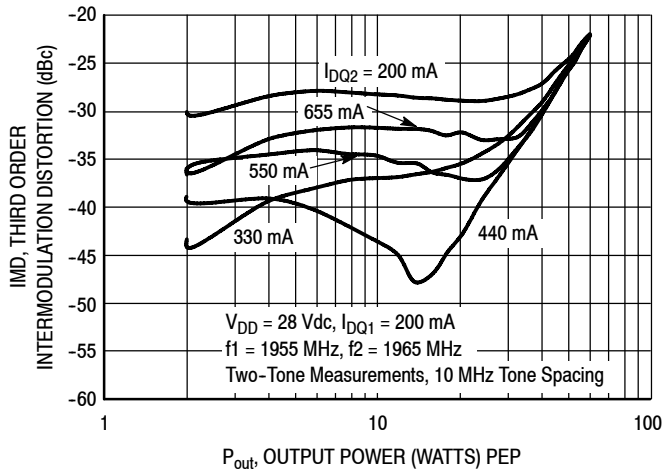

Figure 9. Third Order Intermodulation Distortion versus Output Power @ $I_{DQ1} = 200$ mA

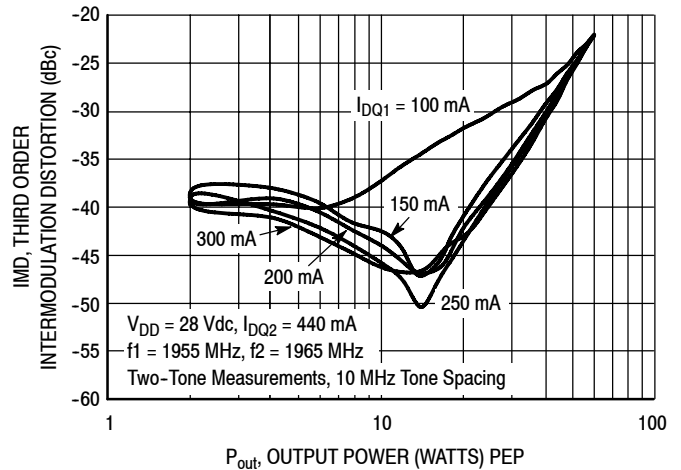

Figure 10. Third Order Intermodulation Distortion versus Output Power @ $I_{DQ2} = 440$ mA

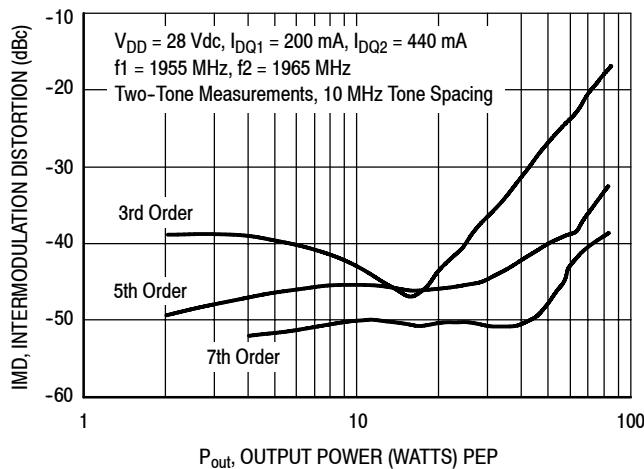

Figure 11. Intermodulation Distortion Products versus Output Power

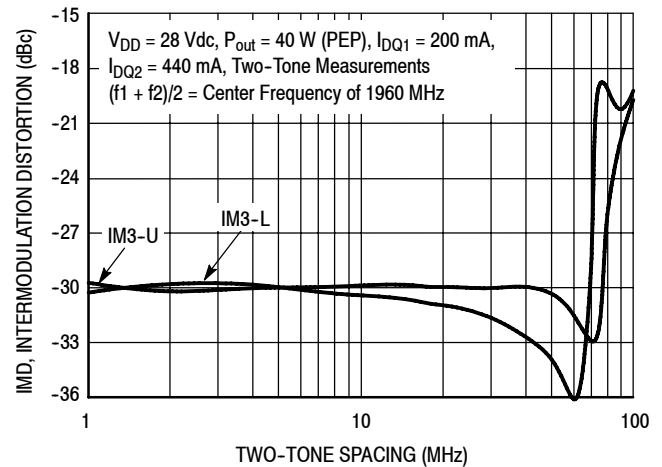

Figure 12. Intermodulation Distortion Products versus Tone Spacing

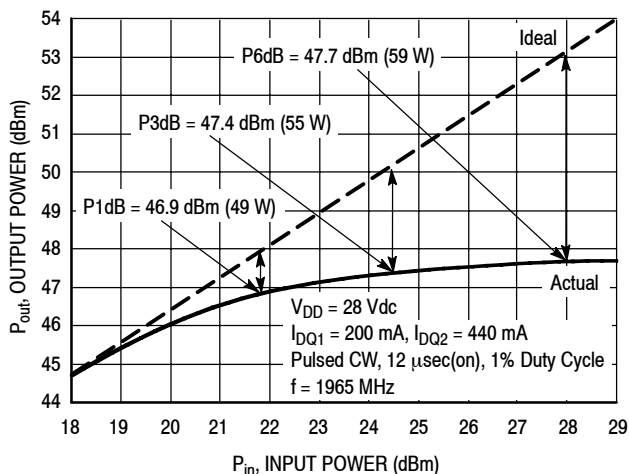

Figure 13. Pulsed CW Output Power versus Input Power

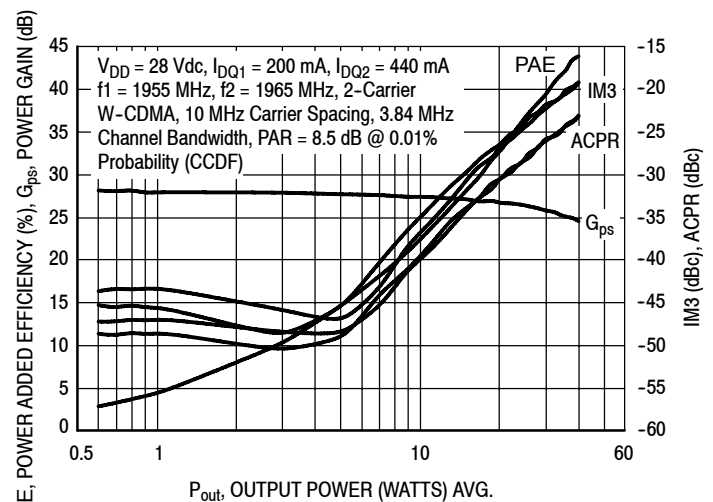

Figure 14. 2-Carrier W-CDMA ACPR, IM3, Power Gain and Drain Efficiency versus Output Power

TYPICAL CHARACTERISTICS

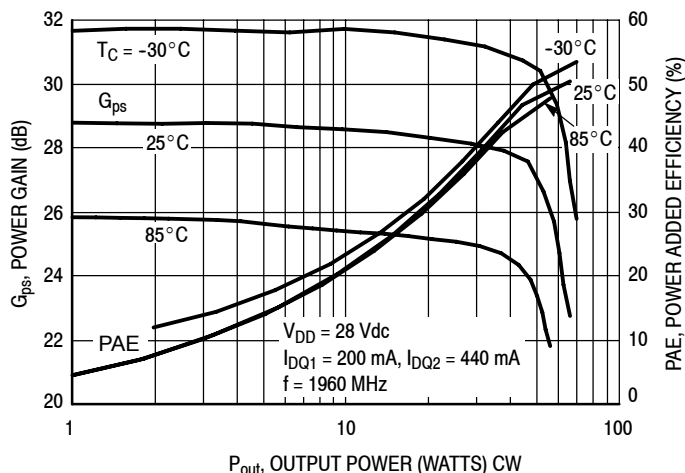

Figure 15. Power Gain and Power Added Efficiency versus Output Power

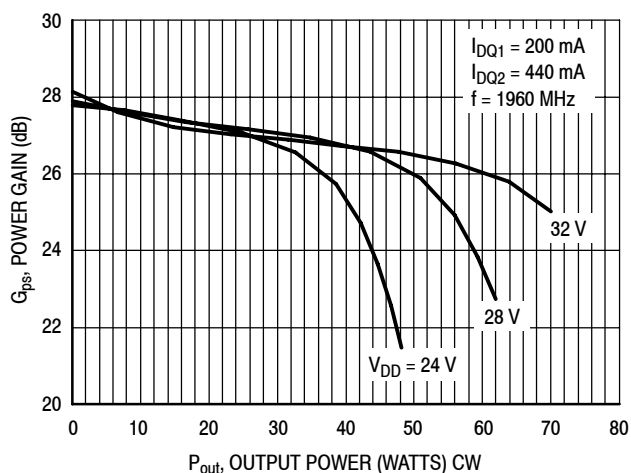

Figure 16. Power Gain versus Output Power

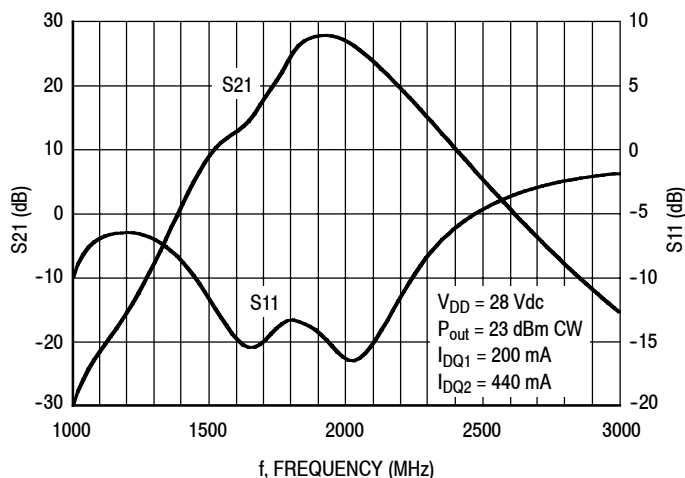

Figure 17. Broadband Frequency Response

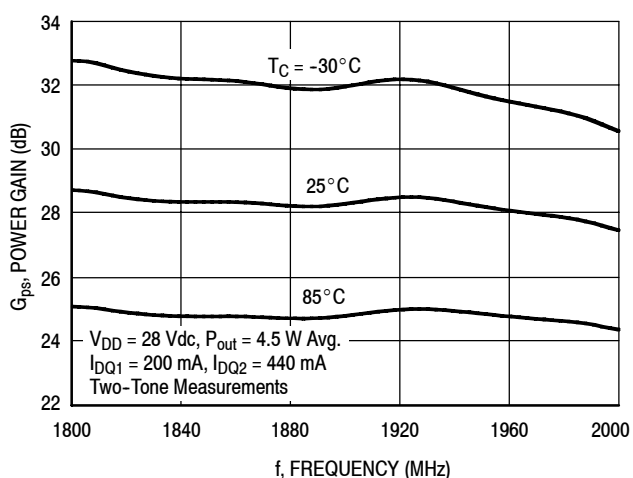
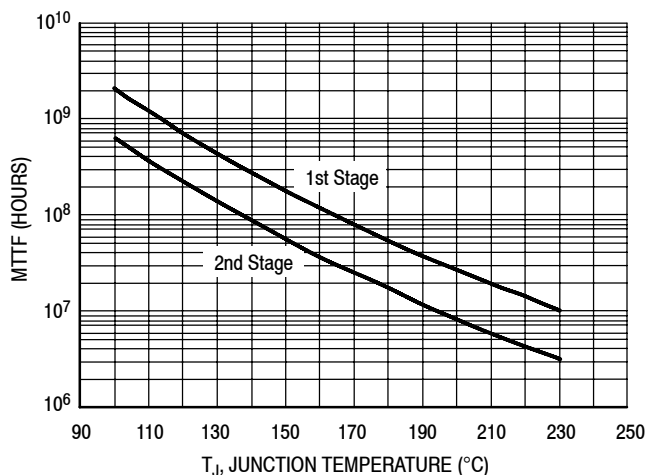

Figure 18. Power Gain versus Frequency



This above graph displays calculated MTTF in hours when the device is operated at $V_{DD} = 28$ Vdc, $P_{out} = 4.5$ W Avg., and $PAE = 13.5\%$.

MTTF calculator available at <http://www.freescale.com/rf>. Select Tools/Software/Application Software/Calculators to access the MTTF calculators by product.

Figure 19. MTTF versus Junction Temperature

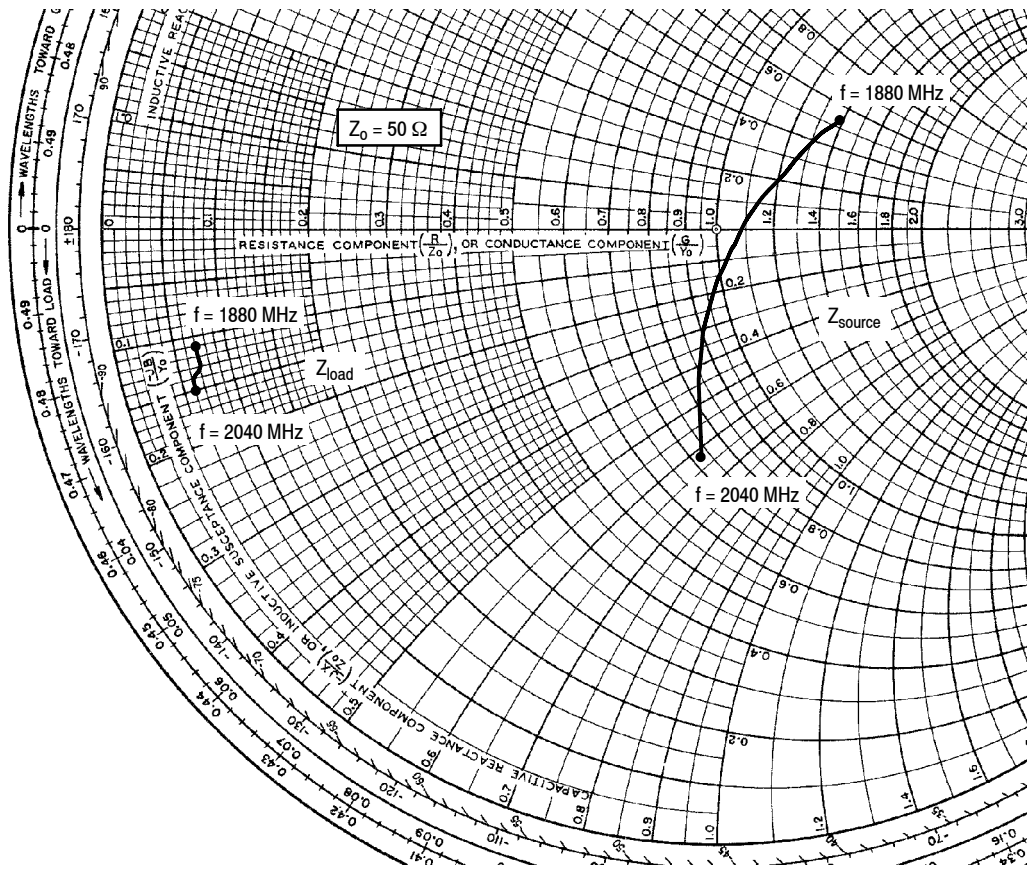

$V_{DD} = 28 \text{ Vdc}$, $I_{DQ1} = 200 \text{ mA}$, $I_{DQ2} = 440 \text{ mA}$, $P_{out} = 4.5 \text{ W Avg.}$

f MHz	Z _{source} Ω	Z _{load} Ω
1880	69.33 + j26.65	3.65 - j5.717
1900	65.20 + j19.39	3.55 - j5.95
1920	61.07 + j12.13	3.45 - j6.18
1940	56.93 + j4.87	3.35 - j6.42
1960	52.80 - j2.39	3.25 - j6.65
1980	48.67 - j9.65	3.15 - j6.88
2000	44.53 - j16.91	3.05 - j7.12
2020	40.40 - j24.17	2.95 - j7.35
2040	36.27 - j31.43	2.85 - j7.583

Z_{source} = Test circuit impedance as measured from gate to ground.

Z_{load} = Test circuit impedance as measured from drain to ground.

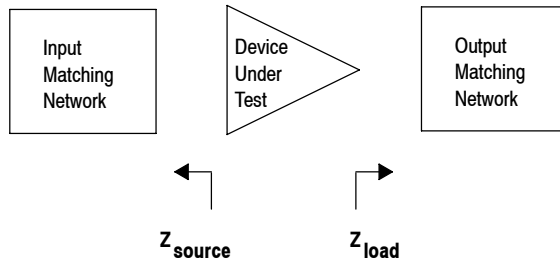

Figure 20. Series Equivalent Source and Load Impedance

Table 7. Common Source Scattering Parameters ($V_{DD} = 28\text{ V}$, $I_{DQ1} = 200\text{ mA}$, $I_{DQ2} = 440\text{ mA}$, $T_C = 25^\circ\text{C}$, 50 ohm system)

f MHz	S ₁₁		S ₂₁		S ₁₂		S ₂₂	
	S ₁₁	∠ φ	S ₂₁	∠ φ	S ₁₂	∠ φ	S ₂₂	∠ φ
1.00	0.196	-167	0.014	-146	0.001	67	0.994	172
1.05	0.331	-176	0.026	-164	0.001	79	0.991	172
1.10	0.419	170	0.041	178	0.001	67	0.990	171
1.15	0.461	157	0.057	160	0.001	66	0.990	170
1.20	0.474	145	0.068	147	0.001	55	0.990	169
1.25	0.467	134	0.084	144	0.001	56	0.989	168
1.30	0.446	122	0.116	143	0.001	56	0.987	167
1.35	0.411	109	0.171	138	0.001	59	0.987	166
1.40	0.365	94	0.256	131	0.001	39	0.986	165
1.45	0.312	78	0.384	122	0.001	45	0.984	164
1.50	0.255	56	0.580	111	0.001	78	0.982	163
1.55	0.205	29	0.879	98	0.001	116	0.980	161
1.60	0.173	-6	1.345	85	0.001	101	0.977	159
1.65	0.172	-45	2.121	70	0.001	130	0.973	157
1.70	0.191	-80	3.478	53	0.001	125	0.968	153
1.75	0.217	-110	6.197	33	0.002	141	0.958	147
1.80	0.236	-144	13.515	5	0.003	157	0.920	130
1.85	0.154	136	39.126	-69	0.009	129	0.453	23
1.90	0.090	-117	20.507	-160	0.006	66	0.816	-159
1.95	0.081	-143	12.215	170	0.005	54	0.881	-178
2.00	0.026	-151	9.054	147	0.003	47	0.892	175
2.05	0.049	-31	7.340	126	0.003	48	0.894	172
2.10	0.119	-31	6.199	105	0.002	41	0.895	170
2.15	0.198	-42	5.298	85	0.002	57	0.895	169
2.20	0.270	-52	4.537	66	0.002	60	0.896	168
2.25	0.334	-61	3.875	47	0.002	66	0.899	167
2.30	0.391	-70	3.282	29	0.002	68	0.905	167
2.35	0.441	-78	2.771	13	0.002	75	0.913	166
2.40	0.485	-85	2.330	-3	0.002	74	0.921	166
2.45	0.523	-92	1.965	-17	0.002	73	0.930	165
2.50	0.557	-97	1.661	-31	0.002	67	0.937	165
2.55	0.587	-103	1.413	-43	0.002	73	0.944	164
2.60	0.617	-109	1.213	-55	0.003	76	0.950	163
2.65	0.643	-114	1.044	-66	0.002	76	0.955	162
2.70	0.665	-119	0.905	-77	0.003	78	0.959	162
2.75	0.687	-124	0.789	-88	0.003	75	0.961	161
2.80	0.706	-129	0.693	-99	0.003	74	0.963	160
2.85	0.723	-134	0.610	-109	0.003	74	0.966	160
2.90	0.737	-139	0.538	-120	0.003	78	0.967	159
2.95	0.751	-143	0.475	-130	0.003	79	0.969	158

(continued)

ARCHIVE INFORMATION

ARCHIVE INFORMATION

Table 7. Common Source Scattering Parameters ($V_{DD} = 28\text{ V}$, $I_{DQ1} = 200\text{ mA}$, $I_{DQ2} = 440\text{ mA}$, $T_C = 25^\circ\text{C}$, 50 ohm system) (continued)

f MHz	S ₁₁		S ₂₁		S ₁₂		S ₂₂	
	S ₁₁	∠ φ	S ₂₁	∠ φ	S ₁₂	∠ φ	S ₂₂	∠ φ
3.00	0.763	-147	0.418	-141	0.003	80	0.968	158
3.05	0.774	-152	0.367	-152	0.004	75	0.969	157
3.10	0.785	-156	0.319	-162	0.004	80	0.966	157
3.15	0.796	-159	0.278	-173	0.004	75	0.967	156
3.20	0.806	-163	0.239	177	0.004	77	0.965	156
3.25	0.815	-166	0.206	167	0.005	75	0.964	155
3.30	0.825	-170	0.176	157	0.005	73	0.964	155
3.35	0.833	-173	0.151	148	0.005	74	0.962	154
3.40	0.841	-176	0.128	140	0.005	71	0.961	154
3.45	0.849	-178	0.110	132	0.005	71	0.958	153
3.50	0.856	179	0.095	125	0.005	65	0.957	153
3.55	0.864	177	0.081	117	0.005	63	0.955	152
3.60	0.872	174	0.070	111	0.006	66	0.952	152
3.65	0.877	172	0.061	104	0.006	60	0.950	151
3.70	0.885	170	0.053	99	0.006	61	0.946	151
3.75	0.891	169	0.047	93	0.006	57	0.943	150
3.80	0.898	167	0.041	89	0.006	57	0.941	150
3.85	0.902	166	0.037	84	0.006	52	0.938	149
3.90	0.911	164	0.033	80	0.006	55	0.934	149
3.95	0.915	163	0.030	76	0.007	54	0.932	148
4.00	0.921	162	0.028	72	0.007	55	0.928	148

ARCHIVE INFORMATION

ARCHIVE INFORMATION

PACKAGE DIMENSIONS

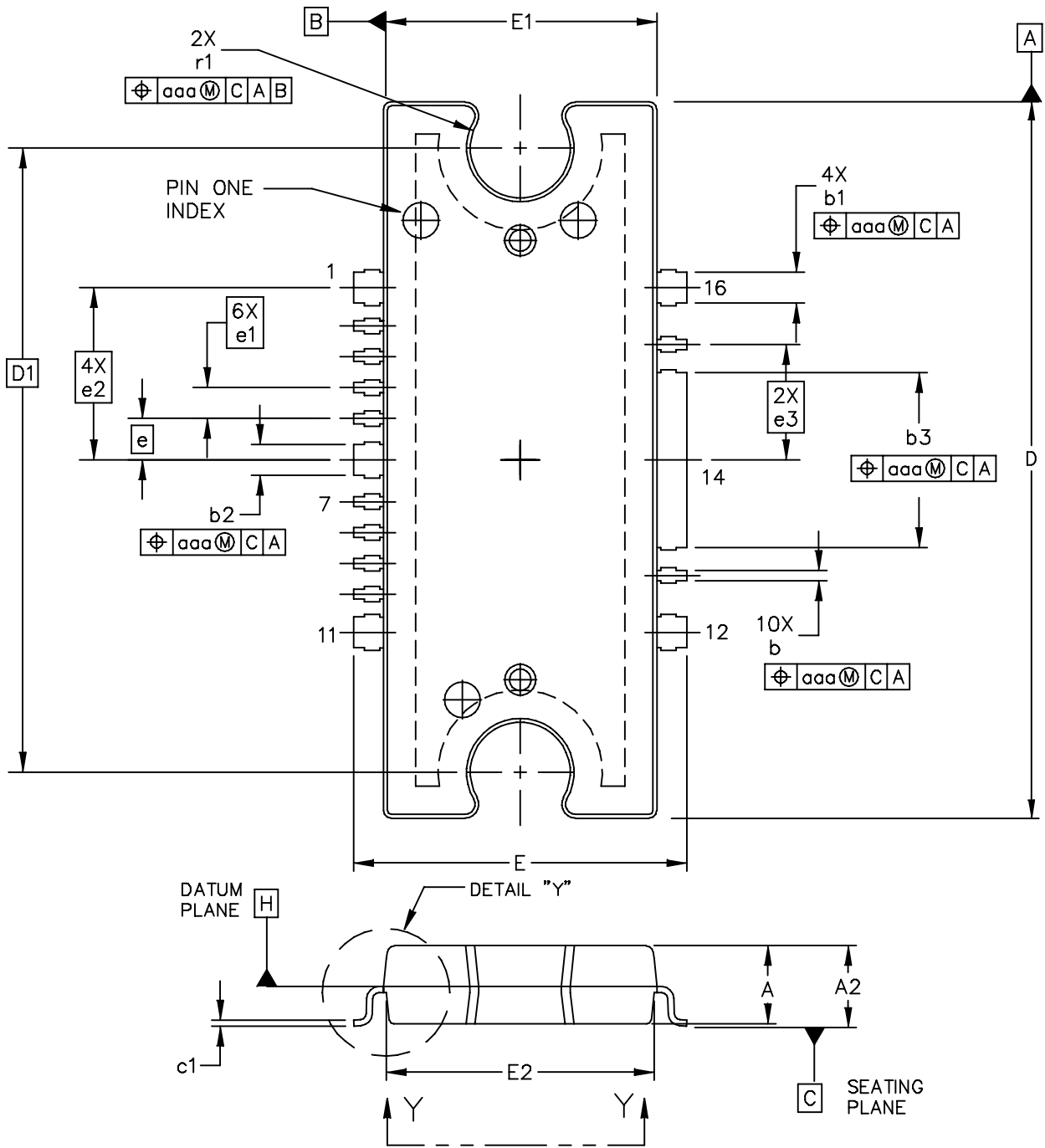

© FREESCALE SEMICONDUCTOR, INC. ALL RIGHTS RESERVED.		MECHANICAL OUTLINE	PRINT VERSION NOT TO SCALE
TITLE: TO-272WB, 16 LEAD GULL WING PLASTIC		DOCUMENT NO: 98ASA10532D	REV: F
		CASE NUMBER: 1329A-04	20 JUN 2007
		STANDARD: JEDEC MO-253 BA	

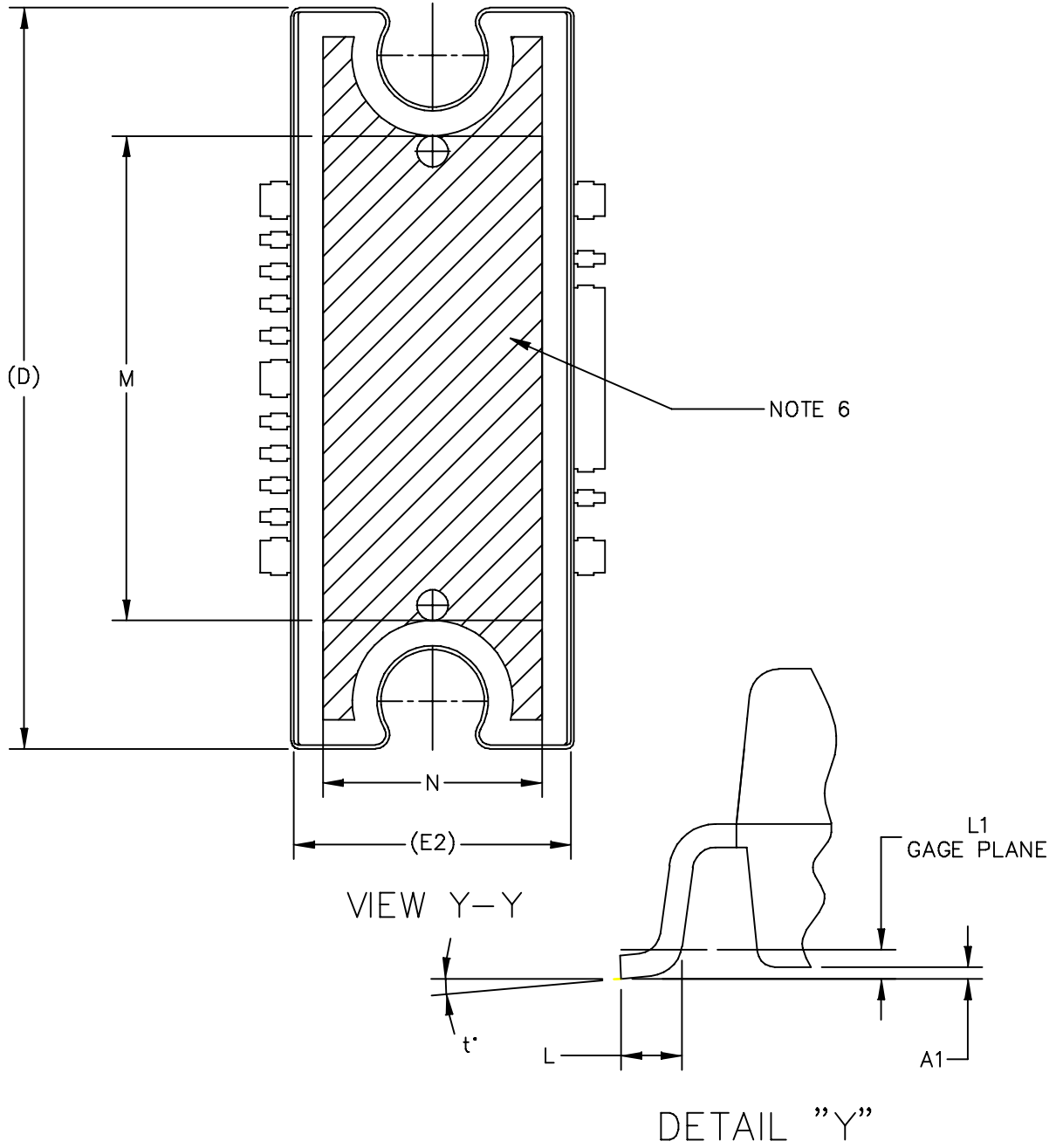

© FREESCALE SEMICONDUCTOR, INC. ALL RIGHTS RESERVED.	MECHANICAL OUTLINE	PRINT VERSION NOT TO SCALE	
TITLE: TO-272WB, 16 LEAD GULL WING PLASTIC	DOCUMENT NO: 98ASA10532D	REV: F	
	CASE NUMBER: 1329A-04	20 JUN 2007	
	STANDARD: JEDEC MO-253 BA		

NOTES:

1. CONTROLLING DIMENSION: INCH
2. INTERPRET DIMENSIONS AND TOLERANCES PER ASME Y14.5M-1994.
3. DATUM PLANE -H- IS LOCATED AT THE TOP OF LEAD AND IS COINCIDENT WITH THE LEAD WHERE THE LEAD EXITS THE PLASTIC BODY AT THE TOP OF THE PARTING LINE.
4. DIMENSIONS "D" AND "E1" DO NOT INCLUDE MOLD PROTRUSION. ALLOWABLE PROTRUSION IS .006 (0.15) PER SIDE. DIMENSIONS "D" AND "E1" DO INCLUDE MOLD MISMATCH AND ARE DETERMINED AT DATUM PLANE -H-.
5. DIMENSIONS "b", "b1", "b2" AND "b3" DO NOT INCLUDE DAMBAR PROTRUSION. ALLOWABLE DAMBAR PROTRUSION SHALL BE .005 (0.13) TOTAL IN EXCESS OF THE "b", "b1", "b2" AND "b3" DIMENSIONS AT MAXIMUM MATERIAL CONDITION.
6. HATCHING REPRESENTS EXPOSED AREA OF THE HEAT SLUG. HATCHED AREA SHOWN IS ON THE SAME PLANE.

ARCHIVE INFORMATION

ARCHIVE INFORMATION

DIM	INCH		MILLIMETER		DIM	INCH		MILLIMETER	
	MIN	MAX	MIN	MAX		MIN	MAX	MIN	MAX
A	.100	.104	2.54	2.64	b	.011	.017	0.28	0.43
A1	.001	.004	0.02	0.10	b1	.037	.043	0.94	1.09
A2	.099	.110	2.51	2.79	b2	.037	.043	0.94	1.09
D	.928	.932	23.57	23.67	b3	.225	.231	5.72	5.87
D1	.810 BSC		20.57 BSC		c1	.007	.011	.18	.28
E	.429	.437	10.9	11.1	e	.054 BSC		1.37 BSC	
E1	.353	.357	8.97	9.07	e1	.040 BSC		1.02 BSC	
E2	.346	.350	8.79	8.89	e2	.224 BSC		5.69 BSC	
L	.018	.024	0.46	0.61	e3	.150 BSC		3.81 BSC	
L1	.01 BSC		0.25 BSC		r1	.063	.068	1.6	1.73
M	.600	----	15.24	----	t	2'	8'	2'	8'
N	.270	----	6.86	----	aaa	.004		.10	
© FREESCALE SEMICONDUCTOR, INC. ALL RIGHTS RESERVED.			MECHANICAL OUTLINE			PRINT VERSION NOT TO SCALE			
TITLE: TO-272 WB 16 LEAD GULL WING PLASTIC					DOCUMENT NO: 98ASA10532D			REV: F	
					CASE NUMBER: 1329A-04			20 JUN 2007	
					STANDARD: JEDEC MO-253 BA				

PRODUCT DOCUMENTATION

Refer to the following documents to aid your design process.

Application Notes

- AN1955: Thermal Measurement Methodology of RF Power Amplifiers
- AN1977: Quiescent Current Thermal Tracking Circuit in the RF Integrated Circuit Family
- AN1987: Quiescent Current Control for the RF Integrated Circuit Device Family

Engineering Bulletins

- EB212: Using Data Sheet Impedances for RF LDMOS Devices

REVISION HISTORY

The following table summarizes revisions to this document.

Revision	Date	Description
0	Nov. 2006	<ul style="list-style-type: none"> • Initial Release of Data Sheet
1	Jan. 2007	<ul style="list-style-type: none"> • Updated verbiage on Typical Performances table, p. 2 • Updated Part Numbers in Table 6, Component Designations and Values, to RoHS compliant part numbers, p. 3 • Added new Figure 13, Pulsed CW Output Power versus Input Power, p. 6 • Added new Figure 18, Power Gain versus Frequency, p. 7 • Replaced Figure 19, MTTF versus Junction Temperature with updated graph. Removed Amps² and listed operating characteristics and location of MTTF calculator for device, p. 7 • Updated Product Documentation adding AN1907 and AN3263, p. 17
2	Dec. 2008	<ul style="list-style-type: none"> • Modified data sheet to reflect RF Test Reduction described in Product and Process Change Notification number, PCN13232, p. 1, 2 • Changed 220°C to 225°C in Capable Plastic Package bullet, p. 1 • Added Footnote 1 to Quiescent Current Temperature bullet under Features section and to callout in Fig. 1, Functional Block Diagram, p. 1 • Changed Storage Temperature Range in Max Ratings table from -65 to +200 to -65 to +150 for standardization across products, p. 2 • Added Case Operating Temperature limit to the Maximum Ratings table and set limit to 150°C, p. 2 • Operating Junction Temperature increased from 200°C to 225°C in Maximum Ratings table and related "Continuous use at maximum temperature will affect MTTF" footnote added, p. 2 • Updated verbiage on Typical Performances table, p. 3 • Updated Part Numbers in Table 6, Component Designations and Values, to latest RoHS compliant part numbers, p. 4 • Adjusted scale for Fig. 11, Intermodulation Distortion Products versus Output Power, to show wider dynamic range, p. 7 • Added new Figure 13, Pulsed CW Output Power versus Input Power, p. 7 • Added new Figure 18, Power Gain versus Frequency, p. 8 • Replaced Figure 19, MTTF versus Junction Temperature with updated graph. Removed Amps² and listed operating characteristics and location of MTTF calculator for device, p. 8 • Replaced Case Outline 1329-09, Issue L, with 1329-09, Issue M, p. 12-14. Added pin numbers 1 through 17. • Replaced Case Outline 1329A-03 with 1329A-04, Issue F, p. 1, 15-17. Added pin numbers 1 through 17. Corrected mm dimension L for gull-wing foot from 4.90-5.06 Min-Max to 0.46-0.61 Min-Max. Corrected L1 mm dimension from .025 BSC to 0.25 BSC. Added JEDEC Standard Package Number. • Data sheet archived. Part no longer manufactured. • Updated Product Documentation adding AN1907 and AN3263, p. 18

(continued)

ARCHIVE INFORMATION

ARCHIVE INFORMATION

REVISION HISTORY (continued)

Revision	Date	Description
3	Mar. 2009	<ul style="list-style-type: none">• Data sheet revised to reflect part status change, p. 1, 4-5, including use of applicable overlay.• Updated Product Documentation removing AN1907 and AN3263, p. 15
3.1	Dec. 2009	<ul style="list-style-type: none">• Corrected data sheet to reflect RF Test Reduction frequency described in Product and Process Change Notification number, PCN13232, p. 1, 2• Rev. 3.1 (MW6IC1940GNBR1) data sheet archived. Part no longer manufactured. See Rev. 4.1 for MW6IC1940NBR1.

ARCHIVE INFORMATION

ARCHIVE INFORMATION

How to Reach Us:**Home Page:**

www.freescale.com

Web Support:

<http://www.freescale.com/support>

USA/Europe or Locations Not Listed:

Freescale Semiconductor, Inc.
Technical Information Center, EL516
2100 East Elliot Road
Tempe, Arizona 85284
1-800-521-6274 or +1-480-768-2130
www.freescale.com/support

Europe, Middle East, and Africa:

Freescale Halbleiter Deutschland GmbH
Technical Information Center
Schatzbogen 7
81829 Muenchen, Germany
+44 1296 380 456 (English)
+46 8 52200080 (English)
+49 89 92103 559 (German)
+33 1 69 35 48 48 (French)
www.freescale.com/support

Japan:

Freescale Semiconductor Japan Ltd.
Headquarters
ARCO Tower 15F
1-8-1, Shimo-Meguro, Meguro-ku,
Tokyo 153-0064
Japan
0120 191014 or +81 3 5437 9125
support.japan@freescale.com

Asia/Pacific:

Freescale Semiconductor China Ltd.
Exchange Building 23F
No. 118 Jianguo Road
Chaoyang District
Beijing 100022
China
+86 10 5879 8000
support.asia@freescale.com

For Literature Requests Only:

Freescale Semiconductor Literature Distribution Center
1-800-441-2447 or +1-303-675-2140
Fax: +1-303-675-2150
LDCForFreescaleSemiconductor@hibbertgroup.com

Information in this document is provided solely to enable system and software implementers to use Freescale Semiconductor products. There are no express or implied copyright licenses granted hereunder to design or fabricate any integrated circuits or integrated circuits based on the information in this document.

Freescale Semiconductor reserves the right to make changes without further notice to any products herein. Freescale Semiconductor makes no warranty, representation or guarantee regarding the suitability of its products for any particular purpose, nor does Freescale Semiconductor assume any liability arising out of the application or use of any product or circuit, and specifically disclaims any and all liability, including without limitation consequential or incidental damages. "Typical" parameters that may be provided in Freescale Semiconductor data sheets and/or specifications can and do vary in different applications and actual performance may vary over time. All operating parameters, including "Typicals", must be validated for each customer application by customer's technical experts. Freescale Semiconductor does not convey any license under its patent rights nor the rights of others. Freescale Semiconductor products are not designed, intended, or authorized for use as components in systems intended for surgical implant into the body, or other applications intended to support or sustain life, or for any other application in which the failure of the Freescale Semiconductor product could create a situation where personal injury or death may occur. Should Buyer purchase or use Freescale Semiconductor products for any such unintended or unauthorized application, Buyer shall indemnify and hold Freescale Semiconductor and its officers, employees, subsidiaries, affiliates, and distributors harmless against all claims, costs, damages, and expenses, and reasonable attorney fees arising out of, directly or indirectly, any claim of personal injury or death associated with such unintended or unauthorized use, even if such claim alleges that Freescale Semiconductor was negligent regarding the design or manufacture of the part.

Freescale™ and the Freescale logo are trademarks of Freescale Semiconductor, Inc. All other product or service names are the property of their respective owners.

© Freescale Semiconductor, Inc. 2006-2009. All rights reserved.

