

Slotted Optical Switch

OPB315 Series



Features:

- Lateral package
- Opaque black plastic
- 850 nm wavelength
- Choice of leads or wires



Description:

Each slotted optical switch in this series consists of an infrared emitting diode (LED) and a NPN silicon phototransistor mounted on opposite sides of a 0.90" (22.9 mm) wide slot in an opaque black plastic package.

The **OPB315L** has 0.25" minimum leads, while the **OPB315WZ** has a minimum of 24" (610 mm) 26 AWG wires.

Phototransistor switching takes place whenever an opaque object passes through the slot.

Applications:

- Non-contact object sensing
- Assembly line automation
- Machine automation
- Equipment security
- Machine safety

Ordering Information					
Part Number	LED Peak Wavelength	Sensor	Slot Width / Depth	Aperture Emitter / Sensor	Wire or Lead Length / Gauge
OPB315L	850 nm	Transistor	0.90"/0.46"	0.03" R / 0.03" R	0.25" / N/A
OPB315WZ					24" min / 26 AWG wires

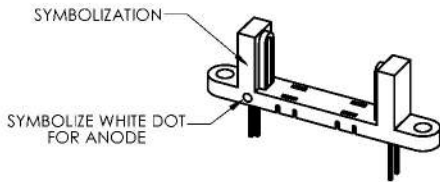

OPB315L

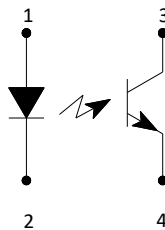

Pin #	LED	Pin #	Transistor
1	Anode	3	Collector
2	Cathode	4	Emitter

NOTES:
1. TOLERANCES ARE ± 0.010 [0.254] UNLESS OTHERWISE SPECIFIED.

DIMENSIONS ARE IN: [MILLIMETERS] INCHES

OPB315L

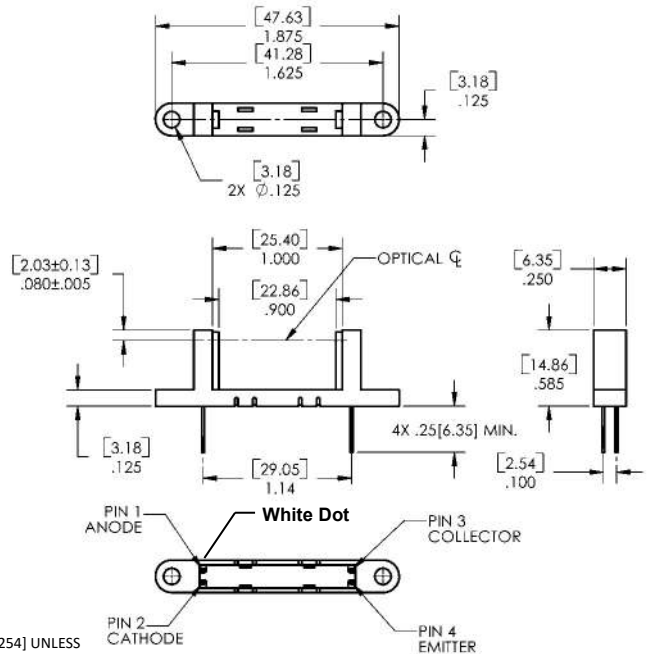

RoHS

General Note

TT Electronics reserves the right to make changes in product specification without notice or liability. All information is subject to TT Electronics' own data and is considered accurate at time of going to print.

TT Electronics | OPTEK Technology
2900 E. Plano Pkwy, Plano, TX 75074 | Ph: +1 972 323 2200
www.ttelectronics.com | sensors@ttelectronics.com

Slotted Optical Switch

OPB315 Series



OPB315WZ

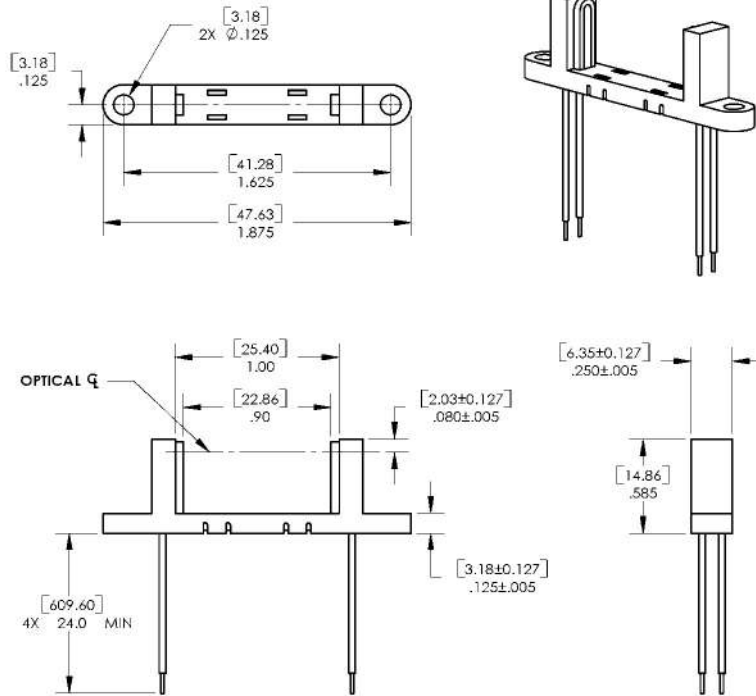

NOTES:
1. TOLERANCES ARE ± 0.010 UNLESS OTHERWISE SPECIFIED.

DIMENSIONS ARE IN: [MILLIMETERS] INCHES

OPB315WZ

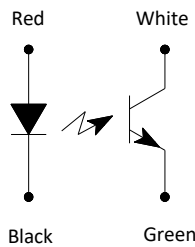

Pin #/ Color	LED	Pin #/ Color	Transistor
Black	Cathode	White	Collector
Red	Anode	Green	Emitter

General Note

TT Electronics reserves the right to make changes in product specification without notice or liability. All information is subject to TT Electronics' own data and is considered accurate at time of going to print.

TT Electronics | OPTEK Technology
2900 E. Plano Pkwy, Plano, TX 75074 | Ph: +1 972 323 2200
www.ttelectronics.com | sensors@ttelectronics.com

Electrical Specifications

Absolute Maximum Ratings ($T_A = 25^\circ\text{C}$ unless otherwise noted)

Storage Temperature Range	-40° C to +80° C
Operating Temperature Range	-40° C to +80° C
Reverse Voltage	2.0 V
Continuous Forward Current	50 mA
Peak Forward Current [measured at 1 μs pulse width and 300 pps]	1.0 A
Lead Soldering Temperature [1/16 inch (1.6 mm) from case for 5 seconds with soldering iron]	260° C ⁽¹⁾⁽²⁾
Power Dissipation (Input Diode)	100 mW
Power Dissipation (Output Phototransistor)	100 mW

Electrical Characteristics ($T_A = 25^\circ\text{C}$ unless otherwise noted)

SYMBOL	PARAMETER	MIN	TYP	MAX	UNITS	TEST CONDITIONS
Input Diode						
V_F	Forward Voltage	-	1.4	1.7	V	$I_F = 20\text{ mA}$
I_R	Reverse Current	-	-	100	μA	$V_R = 2\text{ V}$
Output Phototransistor (see OP550 for additional information)						
$V_{(BR)(CEO)}$	Collector-Emitter Breakdown Voltage	30	-	-	V	$I_{CE} = 100\ \mu\text{A}$, $I_F = 0\text{ mA}$
$V_{(BR)(ECO)}$	Emitter-Collector Breakdown Voltage	5.0	-	-	V	$I_{EC} = 100\ \mu\text{A}$, $I_F = 0\text{ mA}$, $E_E = 0$
I_{CEO}	Collector-Emitter Leakage Current	-	-	100	nA	$V_{CE} = 10.0\text{ V}$, $I_F = 0\text{ mA}$, $E_E = 0$
Coupled						
$I_{C(ON)}$	On-State Collector Current	0.5	1.0	-	mA	$V_{CE} = 0.4\text{ V}$, $I_F = 20\text{ mA}$
$V_{CE(SAT)}$	Collector-Emitter	-	-	0.4	V	$I_C = 500\ \mu\text{A}$, $I_F = 20\text{ mA}$

Notes:

1. RMA flux is recommended. Duration can be extended to 10 seconds maximum when flow soldering.
2. Derate linearly 1.33 mW/° C above 25° C.

General Note

TT Electronics reserves the right to make changes in product specification without notice or liability. All information is subject to TT Electronics' own data and is considered accurate at time of going to print.

Slotted Optical Switch

OPB315 Series



OPB315

Forward Voltage vs Forward Current vs Temperature

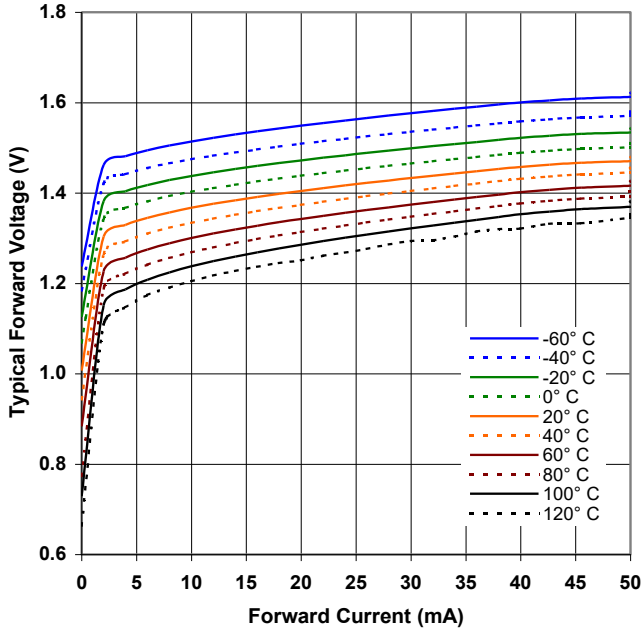

Optical Power vs Forward Current vs Temperature

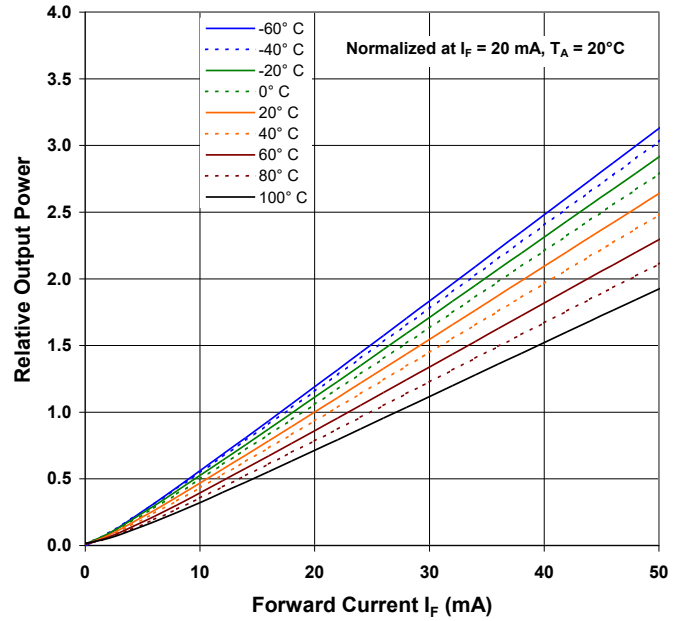

OPB315 - Flag Next to Emitter

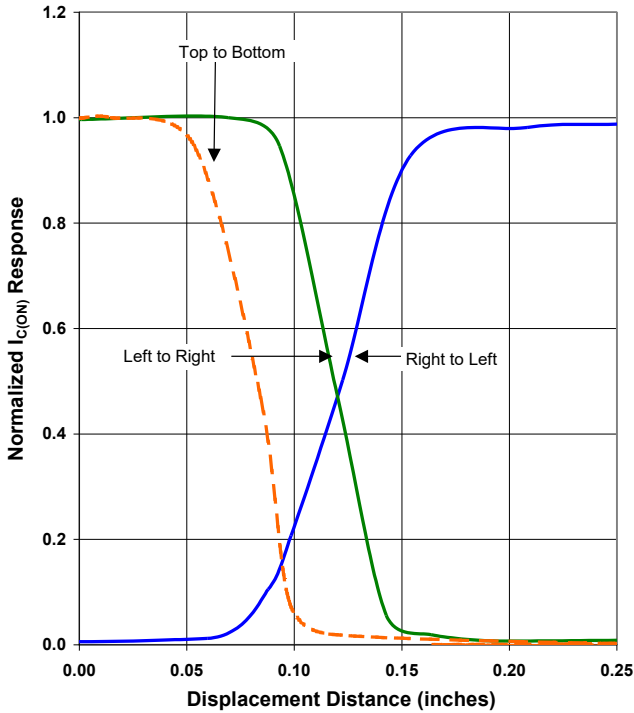

OPB315 - Flag Next to Sensor

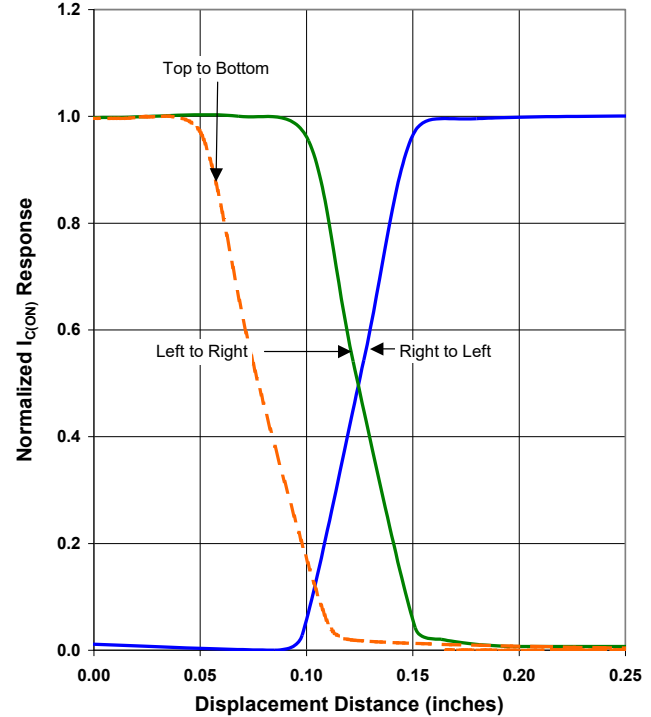

General Note

TT Electronics reserves the right to make changes in product specification without notice or liability. All information is subject to TT Electronics' own data and is considered accurate at time of going to print.

TT Electronics | OPTEK Technology
2900 E. Plano Pkwy, Plano, TX 75074 | Ph: +1 972 323 2200
www.ttelectronics.com | sensors@ttelectronics.com