

# TouchXpress™ Family

## CPT007B Data Sheet

The CPT007B device, part of the TouchXpress family, is designed to quickly replace mechanical buttons with modern capacitive touch buttons by eliminating firmware complexity and reducing development time.

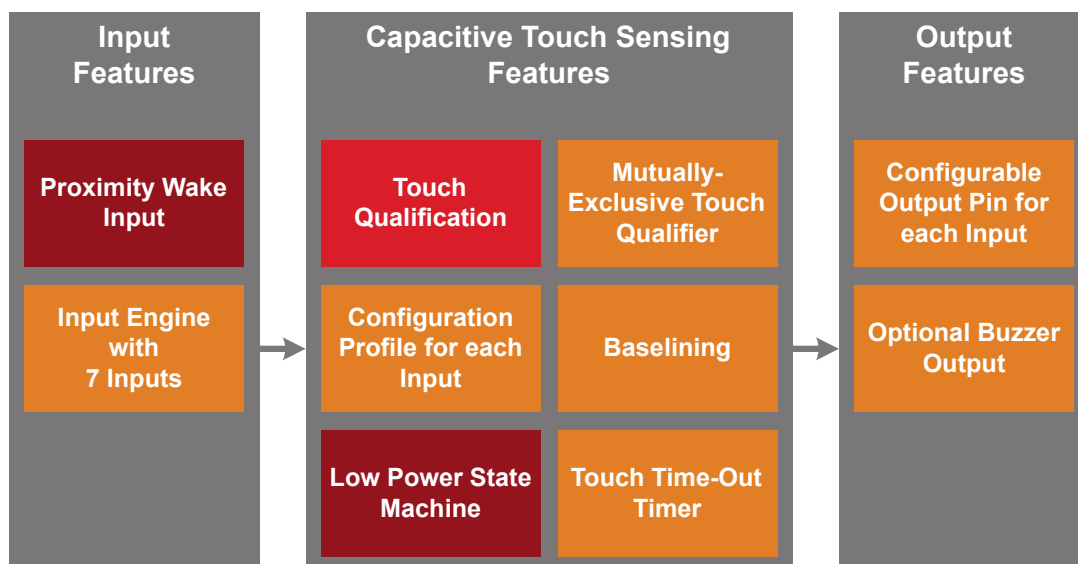
Supporting up to 7 capacitive sensor inputs in packages as small as a 3 mm x 3 mm QFN, the CPT007B is a highly-integrated device that provides a simple solution for adding capacitive touch. The device also comes with advanced features like moisture immunity, wake-on proximity, and buzzer feedback for an enhanced user experience. No firmware development is needed, and all the capacitive touch sense parameters can be configured using a simple GUI-based configurator. By eliminating the need for complex firmware development, the CPT007B device enables rapid user interface designs with minimal development effort.

The CPT007B device is ideal for a wide range of capacitive touch applications, including the following:

- Home appliances
- Instrument / Control panels
- White goods
- Medical equipment
- Consumer electronics
- Lighting control

### KEY FEATURES

- No firmware development required
- Simple GUI-based configurator
- 7 Capacitive Sensor inputs with programmable sensitivity
- 7 General purpose outputs (GPOs) to communicate to the host processor or drive LEDs
- Lowest power capacitive sense solution
  - Active — 200  $\mu$ A
  - Sleep — 1  $\mu$ A
- Wake on proximity
- Superior noise immunity: SNR up to 270:1
- Moisture immunity
- Mutually-exclusive touch qualifier
- Button touch time-out to avoid false touches
- Buzzer output for audible touch feedback



Lowest power mode with feature operational:

- Active
- Optimized Active
- Low Power Sleep

## 1. Feature List and Ordering Information

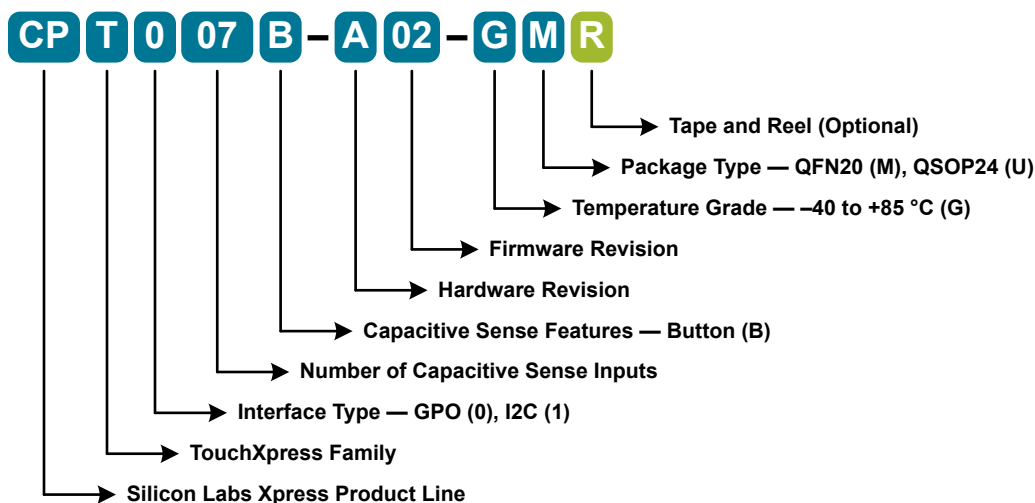


Figure 1.1. CPT007B Part Numbering

The CPT007B has the following features:

- Capacitive sensing input engine with 7 inputs
- Post-sample touch qualification engine
- Configuration profile space in non-volatile memory
- Pin output with configurable polarity and drive strength
- Low power state machine to minimize current draw in all use cases
- Capacitive proximity sensing input
- Buzzer output
- Mutually exclusive touch qualifier
- Touch time-out timer

Table 1.1. Product Selection Guide

Ordering Part Number	Pb-free (RoHS Compliant)	Temperature Range	Package
CPT007B-A02-GM	Yes	-40 to +85 °C	QFN20
CPT007B-A02-GU	Yes	-40 to +85 °C	QSOP24

## 2. Typical Connection Diagrams

### 2.1 Signal, Analog, and Power Connections

Figure 2.1 Connection Diagram on page 2 shows a typical connection diagram for the power pins of CPT007B devices.

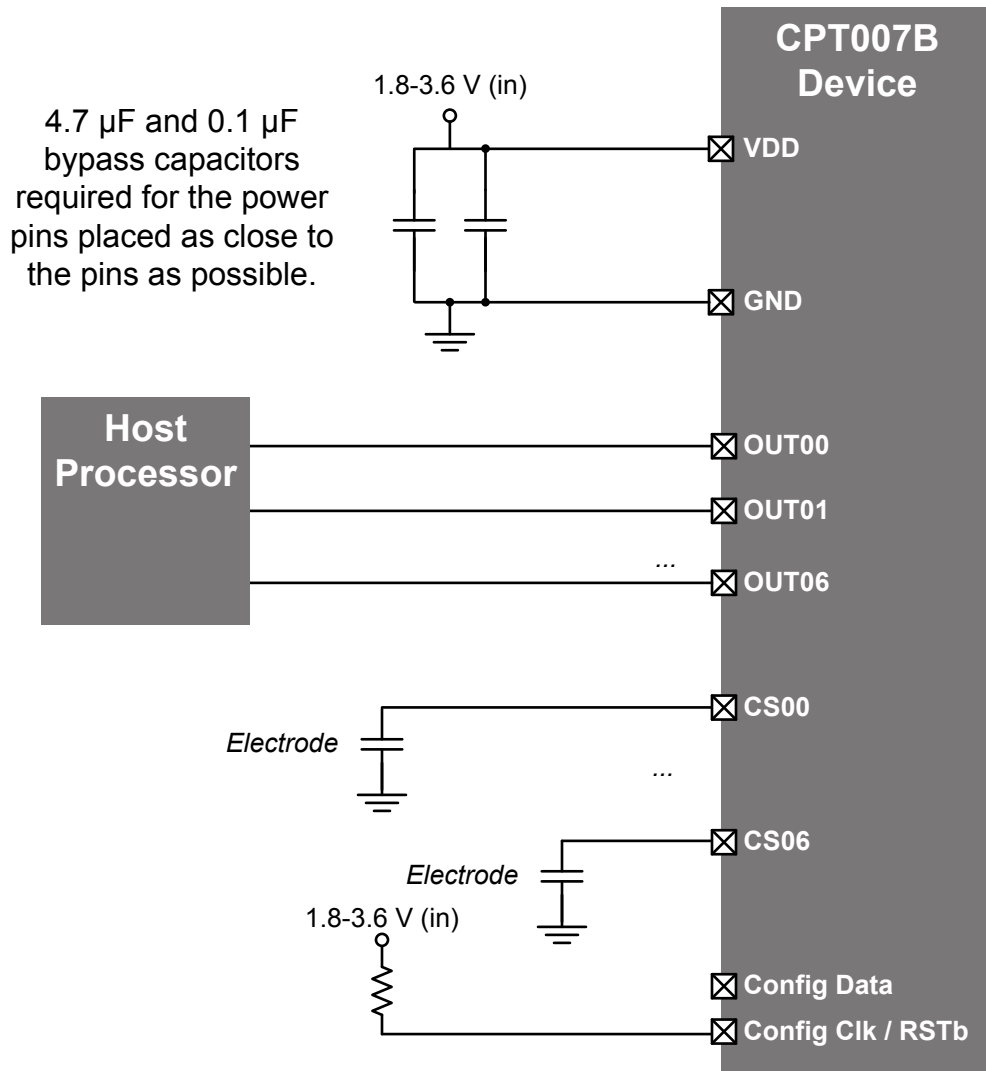


Figure 2.1. Connection Diagram

## 2.2 Configuration

The diagram below shows a typical connection diagram for the configuration connections pins. The ToolStick Base Adapter is available on the evaluation board.

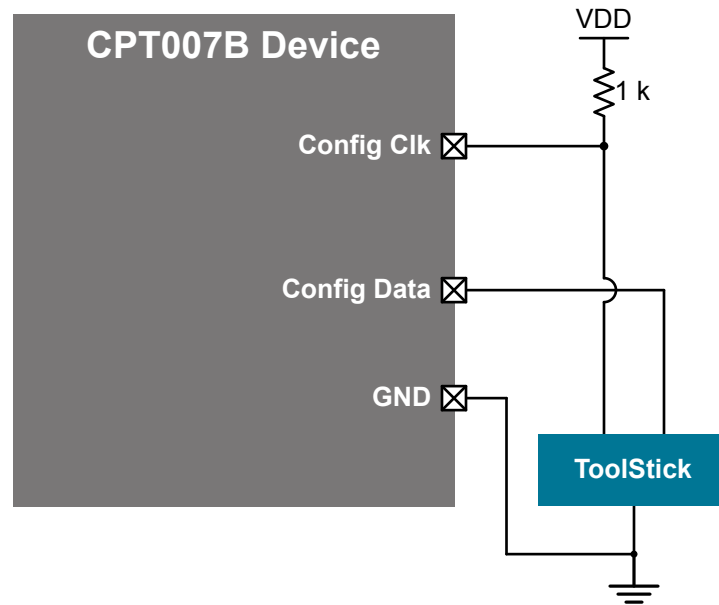


Figure 2.2. Configuration Connection Diagram

### 3. Electrical Specifications

#### 3.1 Electrical Characteristics

All electrical parameters in all tables are specified under the conditions listed in [Table 3.1 Recommended Operating Conditions on page 4](#), unless stated otherwise.

##### 3.1.1 Recommended Operating Conditions

**Table 3.1. Recommended Operating Conditions**

Parameter	Symbol	Test Condition	Min	Typ	Max	Unit
Operating Supply Voltage on VDD	V <sub>DD</sub>		1.8	2.4	3.6	V
Minimum RAM Data Retention Voltage on VDD <sup>1</sup>	V <sub>RAM</sub>	Not in Sleep Mode	—	1.4	—	V
		Sleep Mode	—	0.3	0.5	V
Operating Ambient Temperature	T <sub>A</sub>		−40	—	85	°C

**Note:**

1. All voltages with respect to GND.

### 3.1.2 Power Consumption

See 3.4 [Typical Performance Curves](#) for power consumption plots.

**Table 3.2. Power Consumption**

Parameter	Symbol	Test Condition	Min	Typ	Max	Unit
Active Mode Supply Current	$I_{DD}$		—	3.1	—	mA
Optimized Active Mode Supply Current	$I_{DD}$		—	180	—	$\mu$ A
Sleep Mode Current <sup>1, 2</sup>	$I_{DD}$	3 sensors or fewer	—	0.78	—	$\mu$ A
		4 sensors	—	0.79	—	$\mu$ A
		5 sensors	—	0.81	—	$\mu$ A
		6 sensors	—	0.82	—	$\mu$ A
		7 sensors	—	0.84	—	$\mu$ A
System Current with Varying Scan Time — Base with One Sensor <sup>1</sup>	$I_{DD}$	Scan period = 10 ms	—	154	—	$\mu$ A
		Scan period = 20 ms	—	77	—	$\mu$ A
		Scan period = 50 ms	—	31	—	$\mu$ A
		Scan period = 75 ms	—	21	—	$\mu$ A
		Scan period = 100 ms	—	16	—	$\mu$ A
System Current with Varying Scan Time — Each Additional Sensor <sup>1</sup>	$I_{DD}$	Scan period = 10 ms	—	47	—	$\mu$ A
		Scan period = 20 ms	—	23	—	$\mu$ A
		Scan period = 50 ms	—	9	—	$\mu$ A
		Scan period = 75 ms	—	6	—	$\mu$ A
		Scan period = 100 ms	—	5	—	$\mu$ A

**Note:**

1. Measured with Free Run Mode disabled and sensors set to 4x accumulation, 8x gain.
2. Measured with scan period set to 250 ms.

## 3.1.3 Reset and Supply Monitor

Table 3.3. Reset and Supply Monitor

Parameter	Symbol	Test Condition	Min	Typ	Max	Unit
VDD Supply Monitor Threshold	V <sub>VDDM</sub>	Reset Trigger	1.7	1.75	1.8	V
	V <sub>WARN</sub>	Early Warning	1.8	1.85	1.9	V
Power-On Reset (POR) Monitor Threshold	V <sub>POR</sub>	Rising Voltage on V <sub>DD</sub>	—	1.75	—	V
		Falling Voltage on V <sub>DD</sub>	0.75	1.0	1.3	V
V <sub>DD</sub> Ramp Time	t <sub>RMP</sub>	Time to V <sub>DD</sub> ≥ 1.8 V	—	—	3	ms
RST Low Time to Generate Reset	t <sub>RSTL</sub>		15	—	—	μs
Boot Time <sup>1</sup>	t <sub>boot</sub>	1 sensor	—	25	—	ms
		2 sensors	—	40	—	ms
		3 sensors	—	55	—	ms
		4 sensors	—	70	—	ms
		5 sensors	—	85	—	ms
		6 sensors	—	100	—	ms
		7 sensors	—	115	—	ms

**Note:**

1. Boot time is defined as the time from a power-on reset or /RST pin release until the first capacitive sense scan begins.

## 3.1.4 Configuration Memory

Table 3.4. Configuration Memory

Parameter	Symbol	Test Condition	Min	Typ	Max	Units
Endurance (Write/Erase Cycles)	N <sub>WE</sub>		20 k	100 k	—	Cycles

**Note:**

1. Data Retention Information is published in the Quarterly Quality and Reliability Report.

### 3.1.5 Capacitive Sense

**Table 3.5. Capacitive Sense**

Parameter	Symbol	Test Condition	Min	Typ	Max	Unit
Scan Time Per Sensor <sup>1</sup>	$t_{SCAN}$	Accumulation = 1x	—	64	—	$\mu s$
		Accumulation = 4x	—	256	—	$\mu s$
		Accumulation = 8x	—	512	—	$\mu s$
		Accumulation = 16x	—	1.024	—	ms
		Accumulation = 32x	—	2.048	—	ms
		Accumulation = 64x	—	4.096	—	ms
Signal to Noise Ratio <sup>1, 2</sup>	SNR	Accumulation = 1x	—	90:1	—	codes
		Accumulation = 4x	—	180:1	—	codes
		Accumulation = 8x	—	182:1	—	codes
		Accumulation = 16x	—	210:1	—	codes
		Accumulation = 32x	—	230:1	—	codes
		Accumulation = 64x	—	270:1	—	codes
Conversion Time	$t_{CONV}$	Gain = 1x	—	205	—	$\mu s$
		Gain = 2x	—	123	—	$\mu s$
		Gain = 3x	—	98	—	$\mu s$
		Gain = 4x	—	85	—	$\mu s$
		Gain = 5x	—	76	—	$\mu s$
		Gain = 6x	—	72	—	$\mu s$
		Gain = 7x	—	67	—	$\mu s$
		Gain = 8x	—	64	—	$\mu s$
Total Processing Time <sup>3</sup>	$t_{PROC}$	1 sensor	—	576	—	$\mu s$
		2 sensors	—	796	—	$\mu s$
		3 sensors	—	1.0	—	ms
		4 sensors	—	1.2	—	ms
		5 sensors	—	1.4	—	ms
		6 sensors	—	1.7	—	ms
		7 sensors	—	1.9	—	ms
Maximum External Capacitive Load	$C_{EXTMAX}$	Gain = 8x	—	45	—	pF
		Gain = 1x	—	500	—	pF
Maximum External Series Impedance	$R_{EXTMAX}$	Gain = 8x	—	50	—	k $\Omega$



Parameter	Symbol	Test Condition	Min	Typ	Max	Unit
<b>Note:</b>						
1. Measured with gain set to 8x.						
2. Measured with an evaluation board with 1/16" overlay using Capacitive Sense Profiler.						
3. Sensors configured to 8x gain, 1x accumulation with sensor sampling and system processing time included and mutually-exclusive buttons, buzzer, and touch time-outs disabled.						

### 3.1.6 General Purpose and Buzzer Outputs

**Table 3.6. General Purpose and Buzzer Outputs**

Parameter	Symbol	Test Condition	Min	Typ	Max	Unit
Output High Voltage (High Drive)	V <sub>OH</sub>	I <sub>OH</sub> = -3 mA	V <sub>DD</sub> - 0.7	—	—	V
Output Low Voltage (High Drive)	V <sub>OL</sub>	I <sub>OL</sub> = 8.5 mA	—	—	0.6	V
Output High Voltage (Low Drive)	V <sub>OH</sub>	I <sub>OH</sub> = -1 mA	V <sub>DD</sub> - 0.7	—	—	V
Output Low Voltage (Low Drive)	V <sub>OL</sub>	I <sub>OL</sub> = 1.4 mA	—	—	0.6	V
Weak Pull-Up Current	I <sub>PU</sub>	V <sub>DD</sub> = 1.8 V V <sub>IN</sub> = 0 V	—	-4	—	μA
		V <sub>DD</sub> = 3.6 V V <sub>IN</sub> = 0 V	-35	-20	—	μA

### 3.2 Thermal Conditions

**Table 3.7. Thermal Conditions**

Parameter	Symbol	Test Condition	Min	Typ	Max	Unit
Thermal Resistance*	θ <sub>JA</sub>	QFN20 Packages	—	60	—	°C/W
		QSOP24 Packages	—	65	—	°C/W

**Note:**

1. Thermal resistance assumes a multi-layer PCB with any exposed pad soldered to a PCB pad.

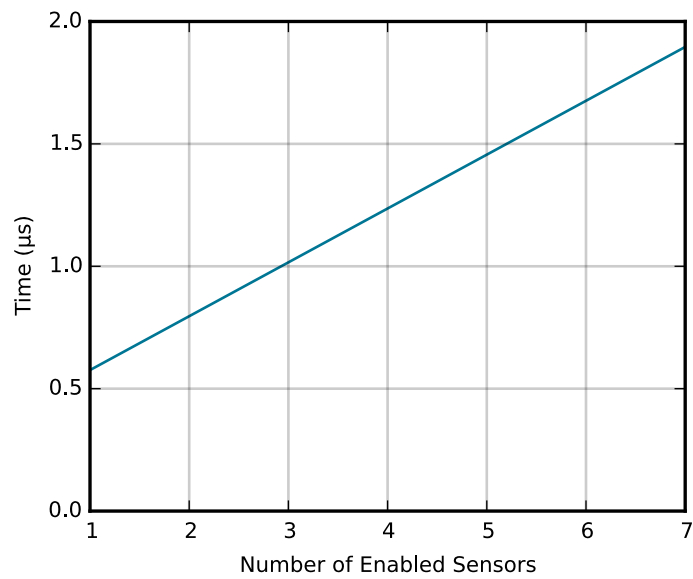
### 3.3 Absolute Maximum Ratings

Stresses above those listed in [Table 3.8 Absolute Maximum Ratings on page 9](#) may cause permanent damage to the device. This is a stress rating only and functional operation of the devices at those or any other conditions above those indicated in the operation listings of this specification is not implied. Exposure to maximum rating conditions for extended periods may affect device reliability. For more information on the available quality and reliability data, see the Quality and Reliability Monitor Report at <http://www.silabs.com/support/quality/pages/default.aspx>.

**Table 3.8. Absolute Maximum Ratings**

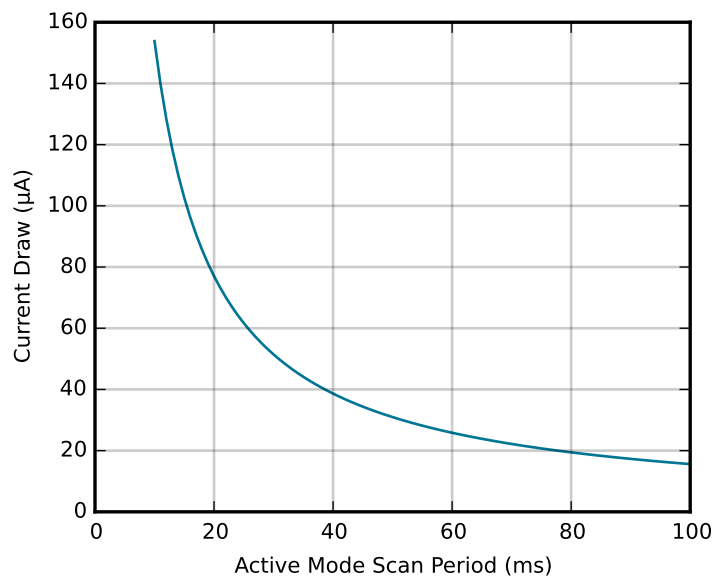
Parameter	Symbol	Test Condition	Min	Max	Unit
Ambient Temperature Under Bias	$T_{BIAS}$		-55	125	°C
Storage Temperature	$T_{STG}$		-65	150	°C
Voltage on $V_{DD}$	$V_{DD}$		GND-0.3	4.0	V
Voltage on I/O pins or RSTb	$V_{IN}$		GND-0.3	$V_{DD} + 0.3$	V
Total Current Sunk into Supply Pin	$I_{VDD}$		—	400	mA
Total Current Sourced out of Ground Pin	$I_{GND}$		400	—	mA
Current Sourced or Sunk by Any I/O Pin or RSTb	$I_{IO}$		-100	100	mA
Maximum Total Current through all Port Pins	$I_{IOTOT}$		—	200	mA
Operating Junction Temperature	$T_J$		-40	105	°C
Exposure to maximum rating conditions for extended periods may affect device reliability.					

### 3.4 Typical Performance Curves

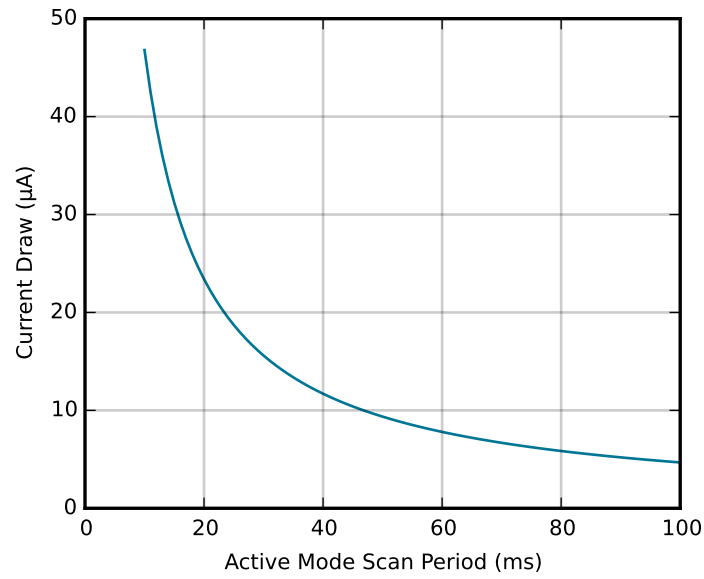


**Figure 3.1. Active Mode Processing Time Per Sensor**

**Note:** Active mode processing time per sensor measured with sensors configured to 1x accumulation, 8x gain. Sensor sampling and system processing time is included with mutually-exclusive buttons, the buzzer, and touch time-outs disabled.

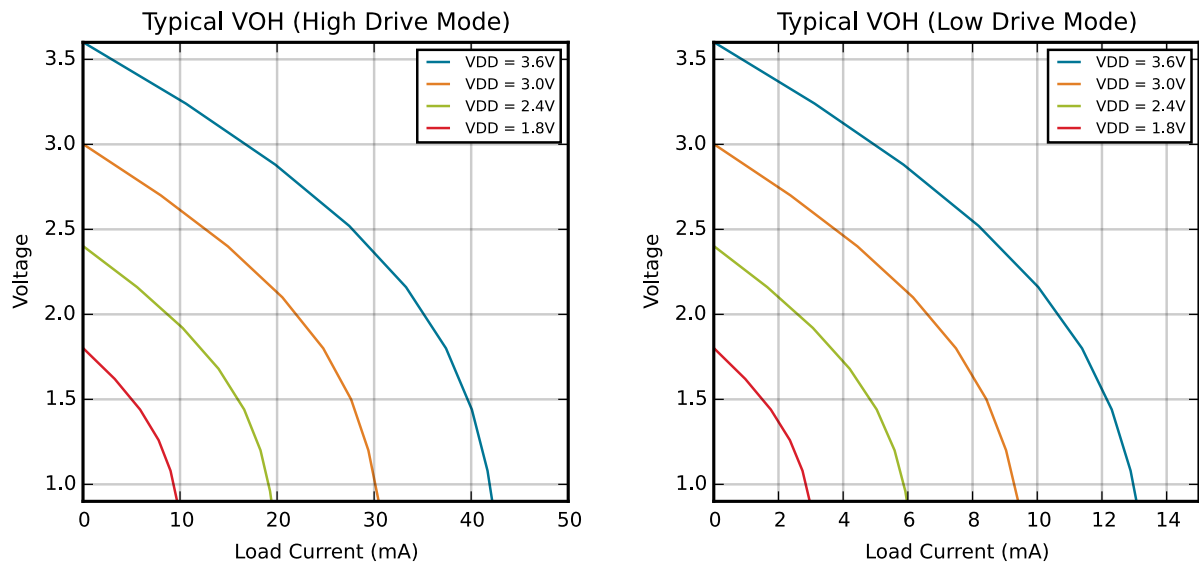


**Figure 3.2. Current vs. Active Mode Scan Period — Base Current Consumption**



**Figure 3.3. Current vs. Active Mode Scan Period — Current Consumption for Each Additional Sensor**

**Note:** Active mode scan period current draw measured with free run mode disabled and all 7 sensors enabled at 4x accumulation, 8x gain. In addition, the buzzer and mutually-exclusive button groups were disabled.



**Figure 3.4. Typical  $V_{OH}$  Curves**

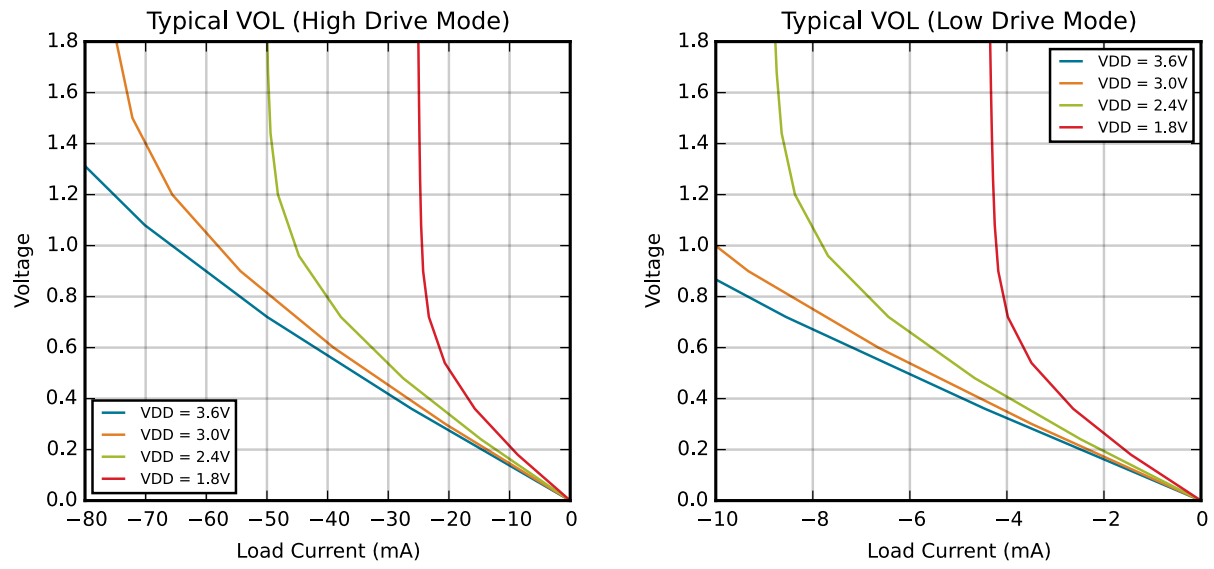


Figure 3.5. Typical VOL Curves

## 4. Functional Description

### 4.1 Capacitive Sensing Input

#### 4.1.1 Introduction

The capacitive to digital converter uses an iterative, charge-timing self-capacitance technique to measure capacitance on an input pin. Sampling is configured and controlled by settings in the non-volatile configuration profile, which can be changed through the 2-pin configuration interface.

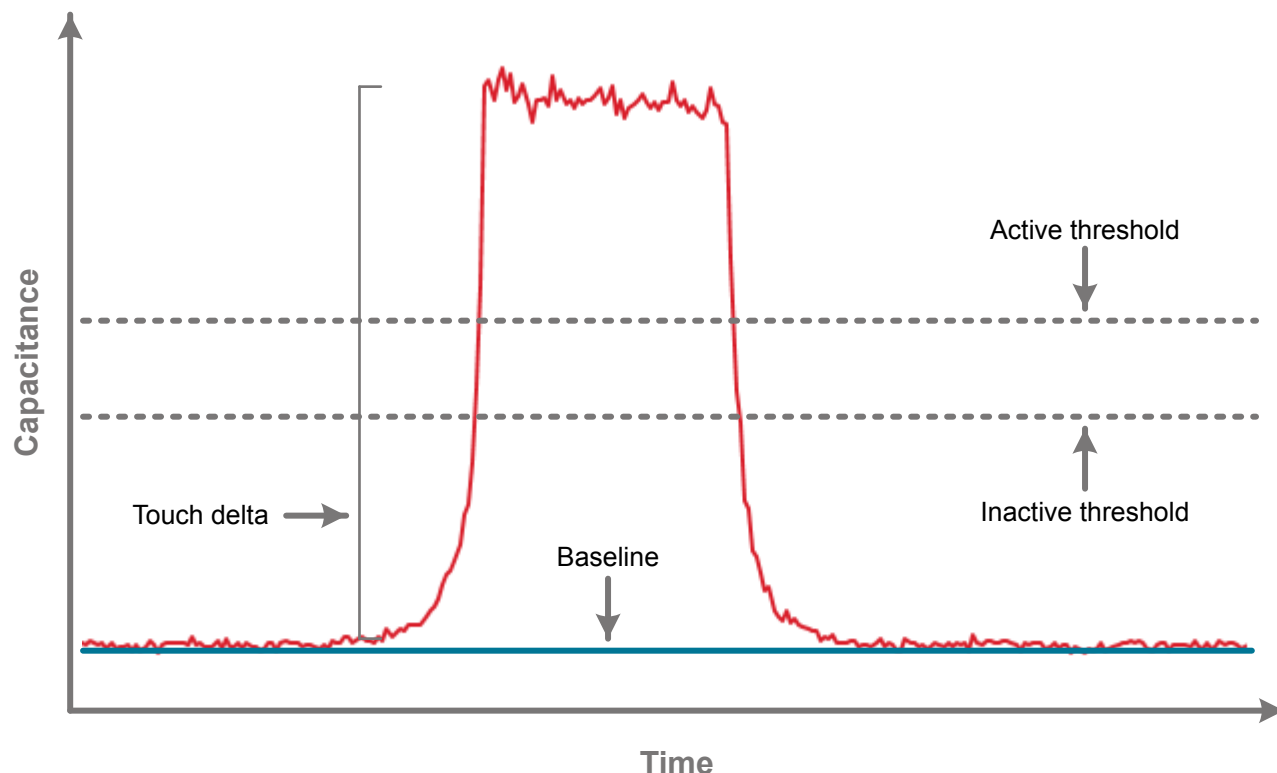


Figure 4.1. Capacitive Sense Data Types

#### 4.1.2 Touch Qualification Criteria

The device detects a touch event when an inactive (untouched) input enabled by the input enable mask detects a sequence of measurements that cross the active threshold.

The device detects a touch release event when an active (touched) input enabled by the input enable mask detects a sequence of measurements that cross the inactive threshold.

The debounce configuration profile parameter defines how many measurements in a row must cross a threshold before a touch or release is qualified. In electrically noisy environments more heavily filtered data is used for qualification.

#### 4.1.3 Thresholds

Capacitive sensing inputs use input-specific thresholds for touch qualification. Each input uses two thresholds, one to detect inactive-to-active transitions on the input, and another to determine active-to-inactive transitions on the input. The inputs use two thresholds to add hysteresis and prevent active/inactive ringing on inputs. Each threshold can be set through Simplicity Studio tools and all thresholds are stored in non-volatile memory in the device's configuration profile.

Thresholds are defined as percentages of a capacitive sensing input's touch delta.

#### 4.1.4 Debounce Counter

Each capacitive sensing input maintains its own debounce counter. For an inactive sensor, this counter tracks the number of successive samples which have crossed that input's active threshold. For an active sensor, this counter tracks the number of successive samples which have crossed the inactive threshold. When the counter reaches a terminal value defined in the the configuration profile, the touch/release event is qualified.

#### 4.1.5 Touch Deltas

Each capacitive sensing input uses a stored touch delta value that describes the expected difference between inactive and active capacitive sensing output codes. This value is stored in the configuration profile for the system and is used by the touch qualification engine, which defines inactive and active thresholds relative to the touch delta.

The touch deltas are stored in the configuration profile in a touch delta/16 format. For this reason, touch deltas must be configured as multiples of 16.

#### 4.1.6 Auto-Accumulation and Averaging

Capacitive sensing inputs have an auto-accumulate and average post-sample filter that can be used to improve signal strength if needed. Settings stored in the configuration profile can configure the engine to accumulate 1, 4, 8, 16, 32, or 64 samples. After the defined number of samples have been accumulated, the result is divided by either 1, 4, 8, 16, 32, or 64, depending on the accumulation setting. This auto-accumulated and averaged value is the sample output used for all touch qualification processing. Note that sample time per sensor increases as the level of accumulation increases. To reduce current consumption, the engine should not be set to auto-accumulate unless it is required to achieve acceptable signal strength due to thick overlays or other system-level factors.

#### 4.1.7 Drive strength

The drive strength of the current source used to charge the electrode being measured by the capacitive sensing input can be adjusted in integer increments from 1x to 8x (8x is the default). High drive strength gives the best sensitivity and resolution for small capacitors, such as those typically implemented as touch-sensitive PCB features. To measure larger capacitance values, the drive strength should be lowered accordingly. The highest drive strength setting that yields capacitive sensing output which does not saturate the sensing engine when the electrode is active (touched) should always be used to maximize input sensitivity.

#### 4.1.8 Active Mode Scan Enable

Active mode scanning of capacitive sensing inputs is controlled by an enable setting for each capacitive sensing input. This setting is stored in the configuration profile.

#### 4.1.9 Active Mode Scan Period

The capacitive sensing input engine stays in active mode whenever one or more inputs have qualified as active. During this time, the sensors scan at a periodicity defined by the active mode scan period, which is stored in the configuration profile. Every active mode scan pushes new samples through the processing engine, which checks for new touch and release events on all enabled inputs.

If free run mode is enabled, the engine will repeatedly scan all enabled inputs during the active mode scan period. In this mode of operation, the active mode scan period is used as a timer to determine how much time has passed since the last qualified active sensor has been seen. When a defined amount of time without a qualified touch event has occurred, the engine switches to a low power mode using the sleep mode scan period, and conserves current.

If free run mode is disabled, the engine will enter a low power state after completing one scan of all enabled inputs and processing the resulting samples. The engine will remain in this low power state until it wakes, at a time defined by active mode scan period, to perform another scan.

#### 4.1.10 Active Mode Scan Type

The active mode scan type, which is stored in the configuration profile, controls whether the capacitive sensing engine in active mode will scan only once during the active mode scan period before going to sleep, or whether the engine will continue scanning as quickly as possible during the active mode scan period, never entering a low power state.

For optimal responsiveness, the engine should be configured to run with free run mode enabled. Setting the scan mode to 'free run' causes touch qualification on a new touch to occur as quickly as the scanning engine can convert and process samples on all sensors. In this mode, qualification time is not bounded by active mode scan period, and is only bounded by scanning configuration factors such as the debounce setting, the number of enabled sensors, the accumulation setting on each sensor, and the timing constraints of any enabled component.

For optimal current draw when in active mode, the engine should be configured to use the 'one scan per period' mode setting. In this case, touch qualification is bound by the scan period and the debounce setting of the device.

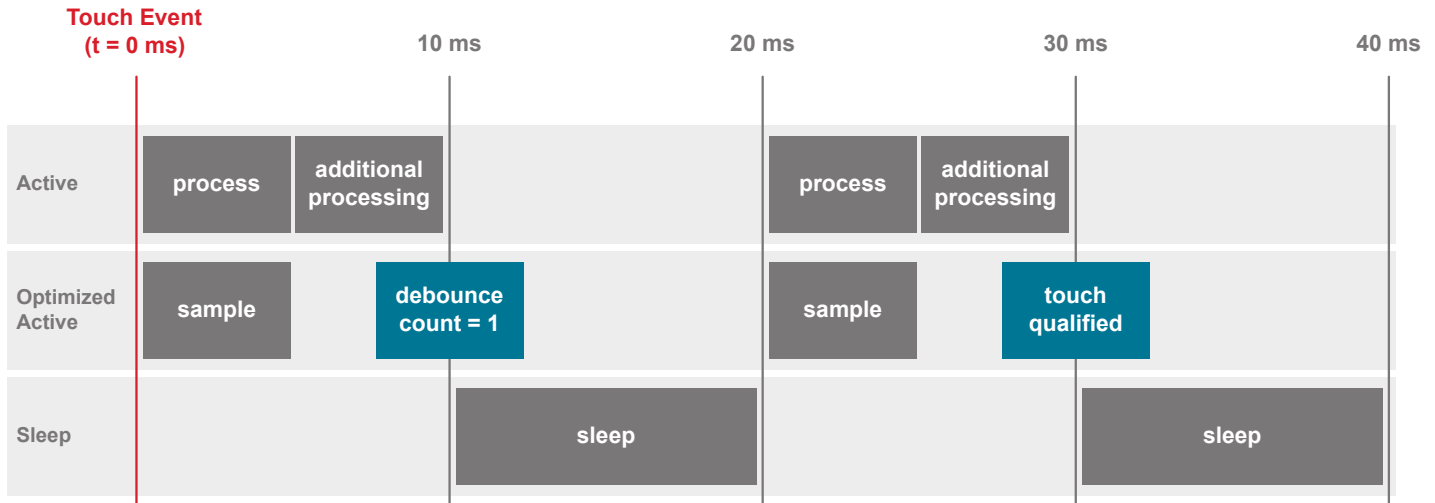


Figure 4.2. Timing and Current — One Sample Per Period Mode

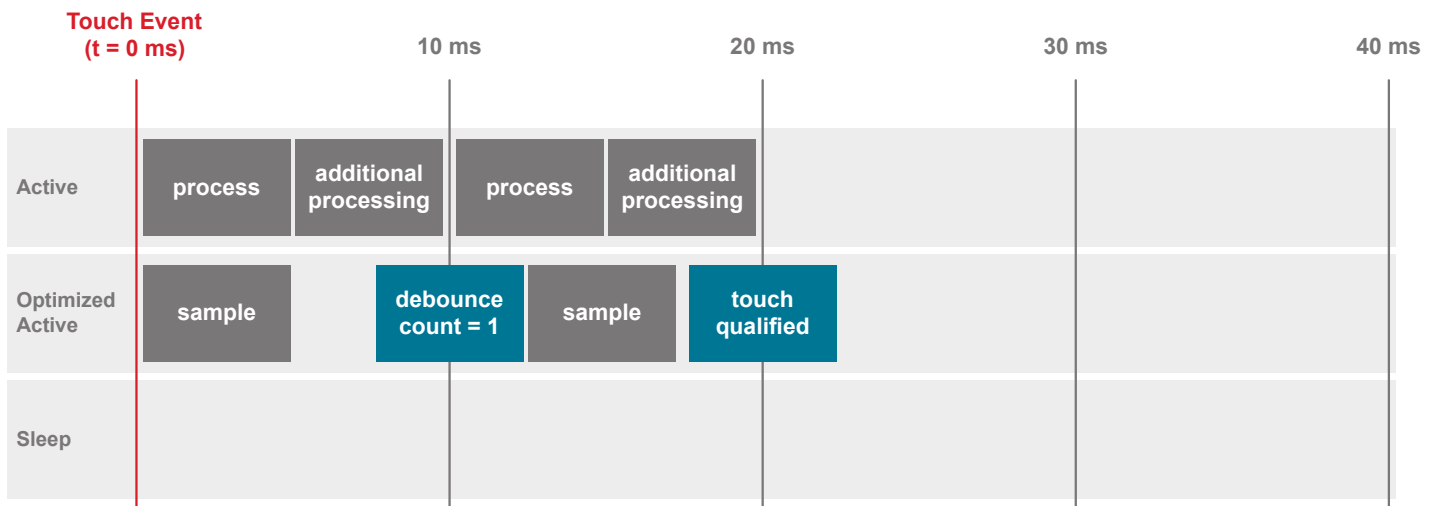


Figure 4.3. Timing and Current — Free Run Mode

#### 4.1.11 Sleep Mode Scan Period

The sleep mode scan period defines the rate at which a scan of the inputs enabled as wake-up sources are sampled. Each enabled sensor can also be enabled as a wake-up source. After the sleep mode scan completes, the scan is processed for a qualified candidate touch. If a candidate touch is qualified, the system wakes from sleep mode and enters active mode scanning.

The sleep mode scan period is stored in the configuration profile and is defined in units of ms.



### 4.1.12 Active Mode and Sleep Mode Transitions

Capacitive sensing inputs will stay in active mode until no inputs detect qualified touches for a span of time defined by the counts until sleep parameter stored in the configuration profile. The scan period of enabled inputs is defined by the active mode scan period, also found in the configuration profile. If free run mode is enabled, the active mode sensing engine will remain awake and scanning the sensors as fast as possible. If free run mode is disabled, the engine will put itself into a low power state for the remainder of the active mode scan period, after a scan has completed.

When in sleep mode, the sensing engine will wake at a period defined by sleep mode scan period to do a scan on sensors that have been enabled as wakeup sources. If the engine finds a candidate touch in this state, the system reverts to active mode to continue scanning.

Note that in systems where a proximity input is selected, the sleep mode scan engine uses conversions on the proximity input instead of sensors enabled as wakeup sources.

Devices configured to wake on a touch will attempt to qualify the candidate touch that initiated the sleep-to-active transition. If qualification completes successfully, the device will signal this qualification to the external system. Touch qualification of this candidate touch uses the same active mode thresholds, debounce setting, and active mode scan period settings as any touch that occurs during active mode scanning.

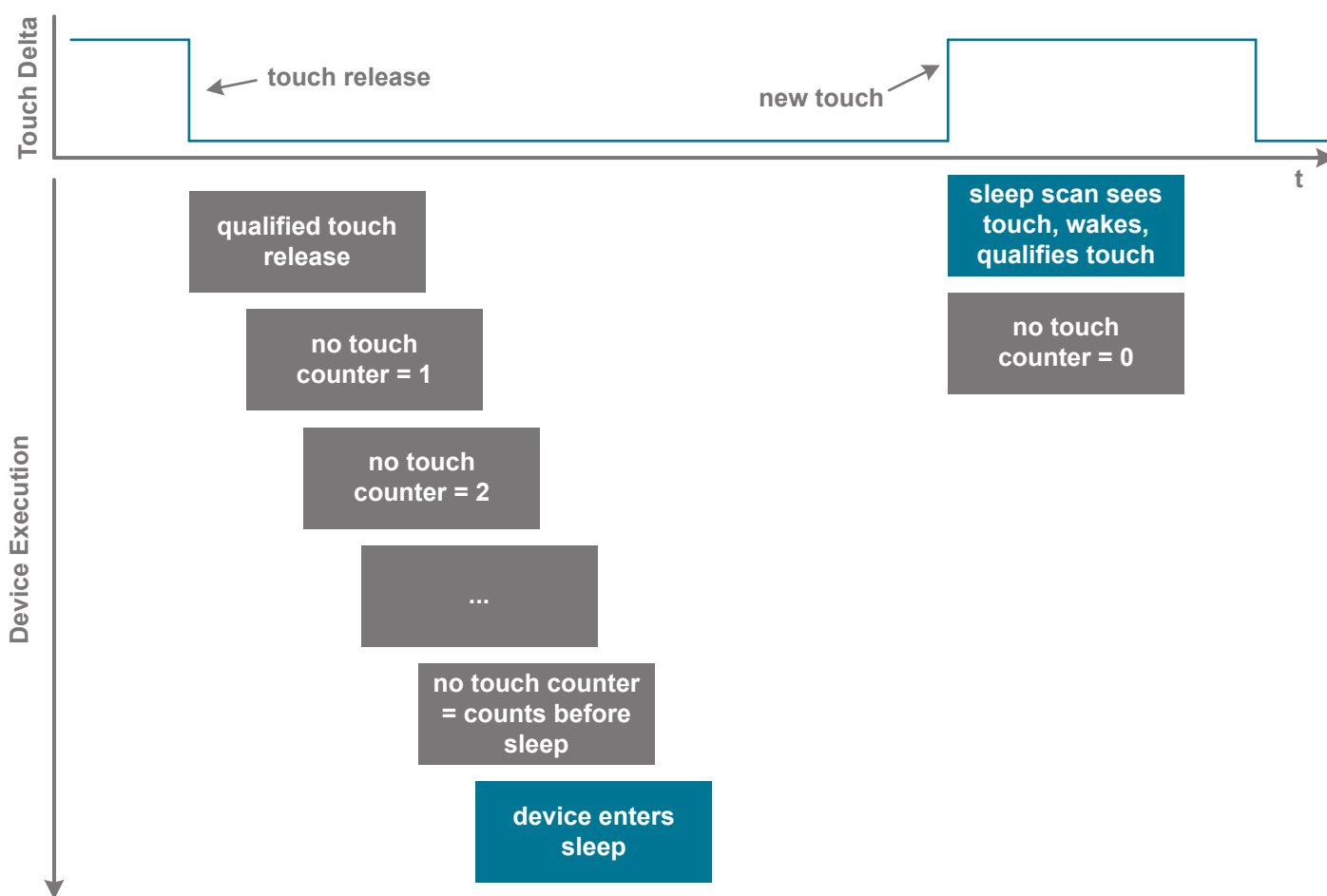


Figure 4.4. Active and Sleep Transitions

## 4.2 Pin Output

### 4.2.1 Introduction

Results of the capacitive sensing touch qualification engine are communicated through a set of digital output pins. The state of each pin is bound to the touch qualification status of one capacitive sensing input pin. If a capacitive sensing input has qualified an active event, the corresponding output pin will be set to its active state. If the input has qualified a release event is inactive, the corresponding output pin will be set to its inactive state. Pin polarity and drive strength are configurable parameters.

## 4.2.2 Configuration

The configuration profile allows users to globally configure outputs as active high or active low. The configuration profile also allows users to globally configure pins as open drain outputs or push-pull outputs.

## 4.3 Capacitive Proximity Sensing

### 4.3.1 Wake on Proximity

The wake on capacitive proximity detection engine monitors for the presence of a conductive object such as a hand to move within detectable range of the sensor. When the engine detects an object, the device wakes from sleep and can begin qualifying touch events on all sensors enabled for active mode sensing.

### 4.3.2 Proximity Sensing Output

Proximity sensing state is output using a designated Out pin on the CPT007B. By choosing this pin, the user is effectively disabling the corresponding CS input pin. If the user is configuring proximity sensing to mode 2 operation, where a single capacitive sensing input pin is used for proximity detection, it is recommended that this input pin be the pin that corresponds to the selected proximity Out pin.

### 4.3.3 Proximity Configuration

The proximity sensing feature uses a single sensor input for proximity qualification. The configuration profile stores the pin chosen by the user. The sensor used for proximity qualification should also have a drive strength setting that is as high as possible without saturating the input when no conductive object is in proximity to the proximity sensor. The accumulation setting of the input is also configurable.

The proximity threshold controls the sensitivity of the input. A lower threshold setting increases sensitivity and increases the range of the sensor.

A proximity sensing input cannot be used for touch qualification, and so the active and inactive thresholds are not used for proximity sensors. Additionally, the proximity input has no effect on other components of the device such as mutually exclusive button groups, buzzer output, touch time out timers, and sliders.

## 4.4 Touch Time-Out

The touch time-out feature can be enabled and disabled through the configuration profile. When enabled, the device will monitor touch event duration on each input independently.

When a touch event exceeds a duration specified in the configuration profile, the device forces a release event, even if the user is still actively touching the sensor.

The feature qualifies a touch release by adding the configured touch delta value for that sensor to the sensor's current baseline value. By doing this, the raw data-to-baseline delta created by the touch will be removed, and the touch qualification engine will see this as a touch release event.

When the user removes a finger from a sensor that had been qualified active but has been qualified released through touch timeout, the resulting raw-to-baseline negative delta will be aggressively tracked downward by the baseline, resulting in a sensor that remains sensitive to successive touches.

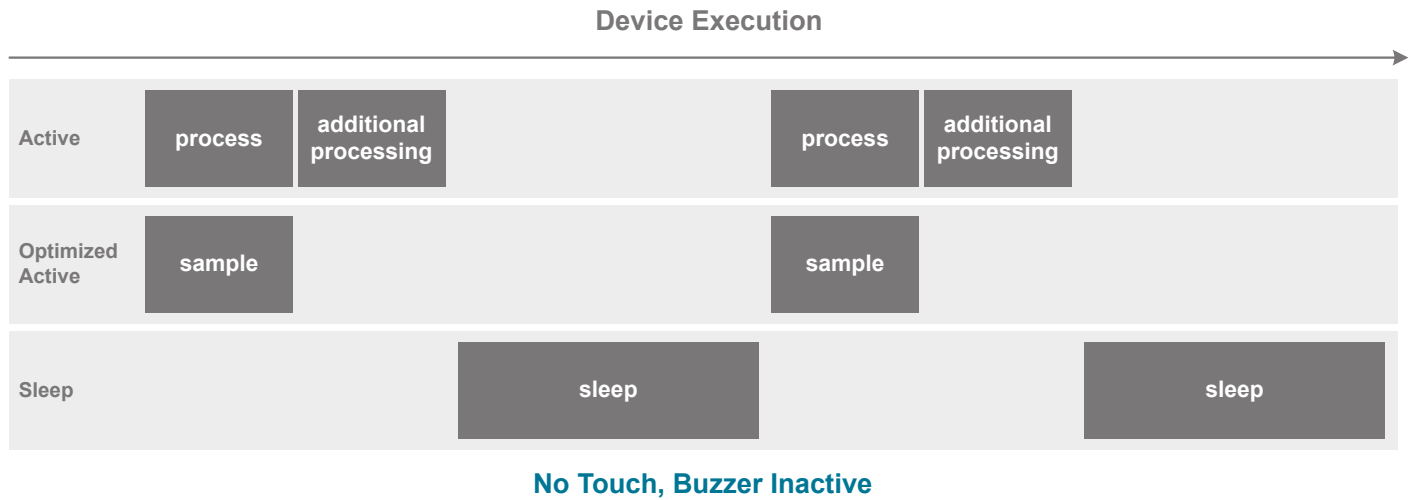
The touch timeout duration is configured globally, so all inputs are monitored for the same touch duration.

If both the touch timeout feature and the mutually exclusive button group feature are enabled, the timeout timer will only run on the touch that is externally reported as being active.

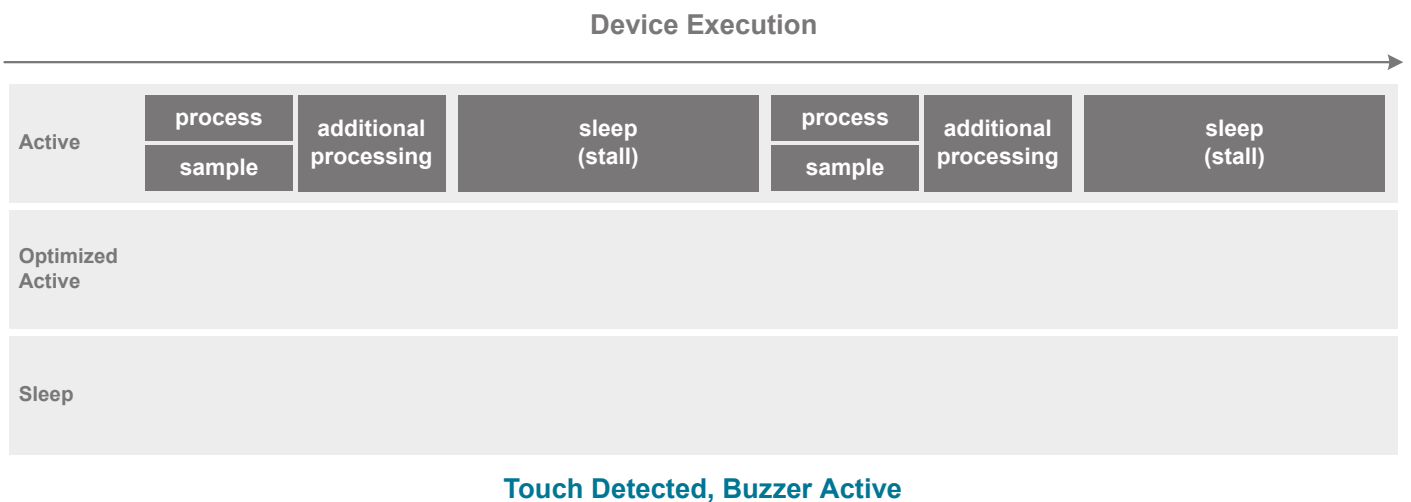
## 4.5 Buzzer Output

### 4.5.1 Introduction

The buzzer output engine produces a square wave of a configurable duration and frequency when a capacitive sensing input goes from inactive to active. The feature can be enabled and disabled through the configuration profile. The configuration profile also includes the settings for active duration and frequency.



**Figure 4.5. Effects of the Buzzer on Current Draw — Active Mode, No Touch, Buzzer Inactive**



**Figure 4.6. Effects of the Buzzer on Current Draw — Active Mode, Touch Detected, Buzzer Active**

#### 4.5.2 Buzzer Configuration

If enabled, buzzer output will be routed to the Buzzer pin (pin 7) of the CPT007B. When activated, the buzzer will remain active for either the duration specified in the configuration profile, or until the last active sensor has qualified a touch release.

The configuration profile supports configuration of output frequencies ranging from 1 kHz to 4 kHz.

The configuration profile can configure the buzzer output pin to either push pull mode or open drain mode.

#### 4.6 Mutually Exclusive Buttons

When enabled through the configuration profile, this system allows one and only one capacitive sensing input to be qualified as active at a time. The first sensor active will remain the only sensor active until released. The device will internally qualify multiple touch and release events but will not report them.

If multiple sensors have been internally qualified as active, the first sensor's touch event will be reported. If a touch event occurs simultaneously on more than one sensor, the touch with the highest touch delta will be reported.

If two sensors are qualified as active and the sensor being reported as active qualifies a touch release, the device will report that release and then report a touch qualification on the still-active second sensor.

In the case where a device has simultaneously qualified more than two active sensors and the reported active sensor qualifies and reports a release, the remaining qualified sensor with the highest sensor name will then be reported. For example, if sensors CS00, CS01, and CS02 are active with CS00 externally reported as active, after CS00's release, CS02 would be externally reported as an active sensor unless the device has already qualified a touch release on CS02.

If both the touch timeout feature and the mutually exclusive button group feature are enabled, the timeout timer will only run on the touch that is externally reported as being active.

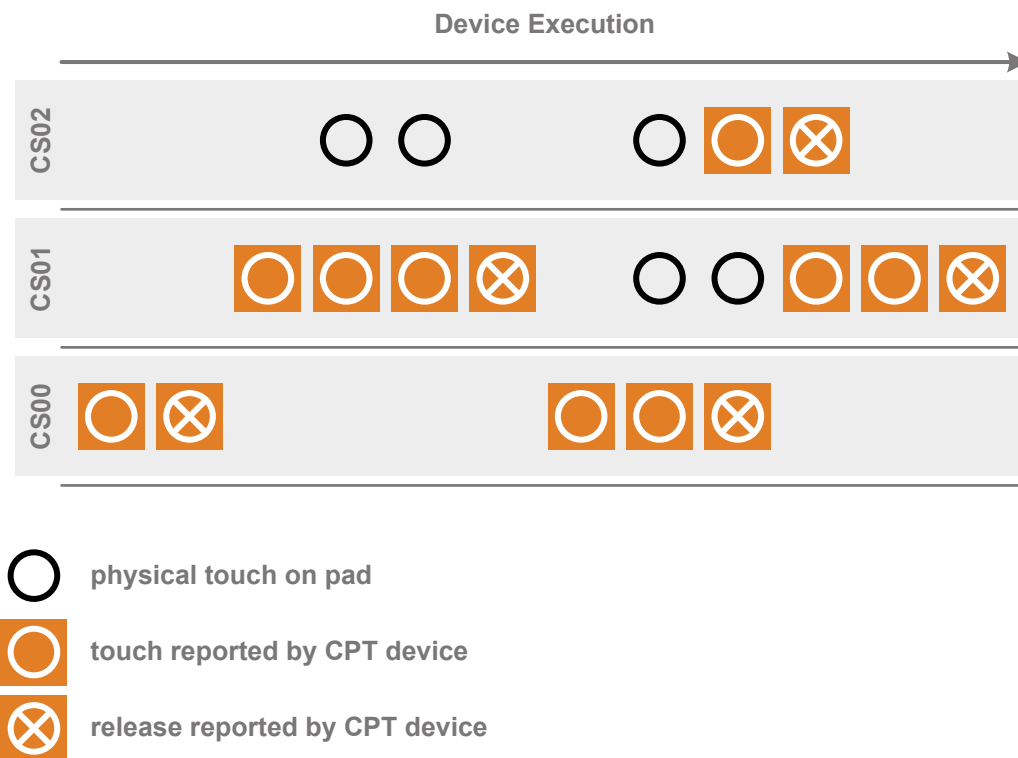


Figure 4.7. Mutually-Exclusive Button Operation

## 4.7 Self Testing

### 4.7.1 Introduction

When the self-test feature is enabled through the configuration profile, the device performs a check on all enabled capacitive sensing inputs upon startup to determine whether the sensing input pins are erroneously shorted to ground or supply. If a short or open is found on a sensor, the self test feature will signal that an error has been found through a port pin. The feature will then disable that sensor before beginning touch qualification scans on all sensors left enabled.

### 4.7.2 Test Failure Signaling

If the self test check reveals an error, the device will toggle the buzzer output pin at a frequency of 2 Hz. This toggling will persist for two seconds if the device detects one or more self test errors.

#### 4.8 Configuration Profile

The configuration interface is used by the device to configure default values and performance characteristics that effect capacitive sensing. The configuration data can be programmed through the Configuration interface (Config Clk and Config Data pins) using [**Configurator**] in Simplicity Studio.

Several configuration profile templates are available in Simplicity Studio to provide a starting point for development.

## 5. Pin Definitions

### 5.1 CPT007B QFN20 Pin Definitions

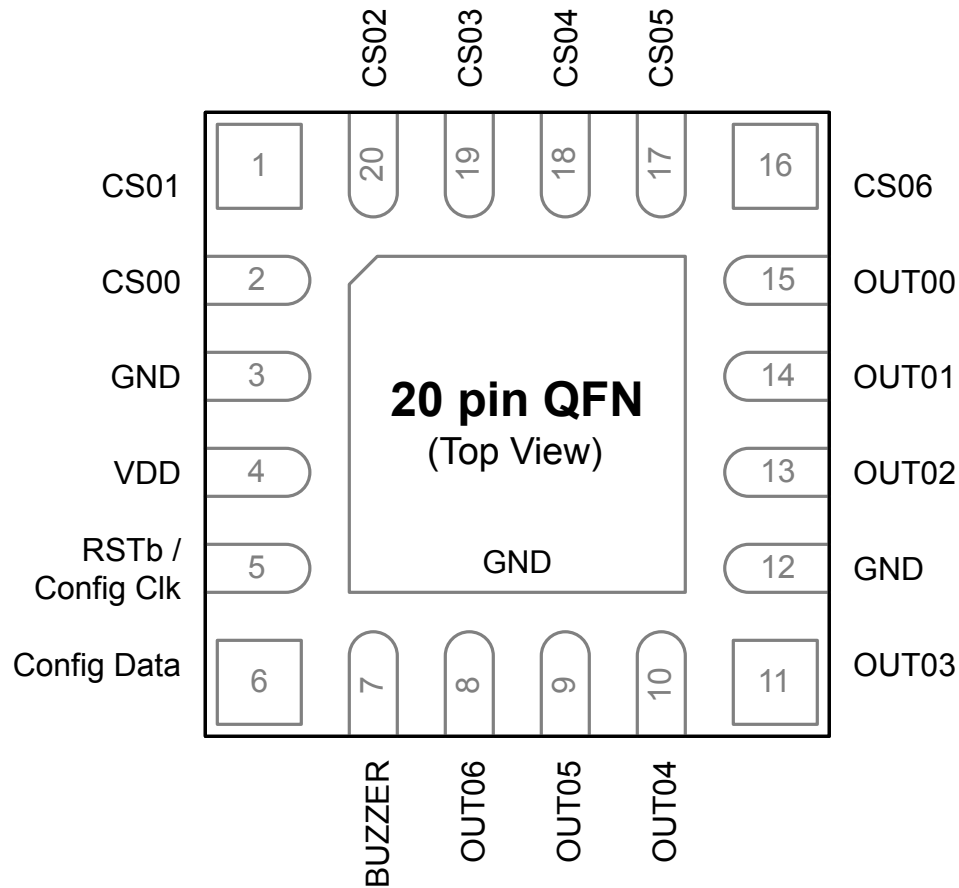


Figure 5.1. CPT007B QFN20 Pinout

Table 5.1. Pin Definitions for CPT007B QFN20

Pin Number	Pin Name	Description
1	CS01	Analog input Capacitive sensing input 1
2	CS00	Analog input Capacitive sensing input 0
3	GND	Ground
4	VDD	Supply power input
5	RSTb / Config Clk	Active-low reset / Configuration clock
6	Config Data	Configuration data

Pin Number	Pin Name	Description
7	Buzzer	Push-pull output Buzzer output
8	OUT06	Push-pull output Sensing state of CS06
9	OUT05	Push-pull output Sensing state of CS05
10	OUT04	Push-pull output Sensing state of CS04
11	OUT03	Push-pull output Sensing state of CS03
12	GND	Ground
13	OUT02	Push-pull output Sensing state of CS02
14	OUT01	Push-pull output Sensing state of CS01
15	OUT00	Push-pull output Sensing state of CS00
16	CS06	Analog input Capacitive sensing input 6
17	CS05	Analog input Capacitive sensing input 5
18	CS04	Analog input Capacitive sensing input 4
19	CS03	Analog input Capacitive sensing input 3
20	CS02	Analog input Capacitive sensing input 2

5.2 CPT007B QSOP24 Pin Definitions

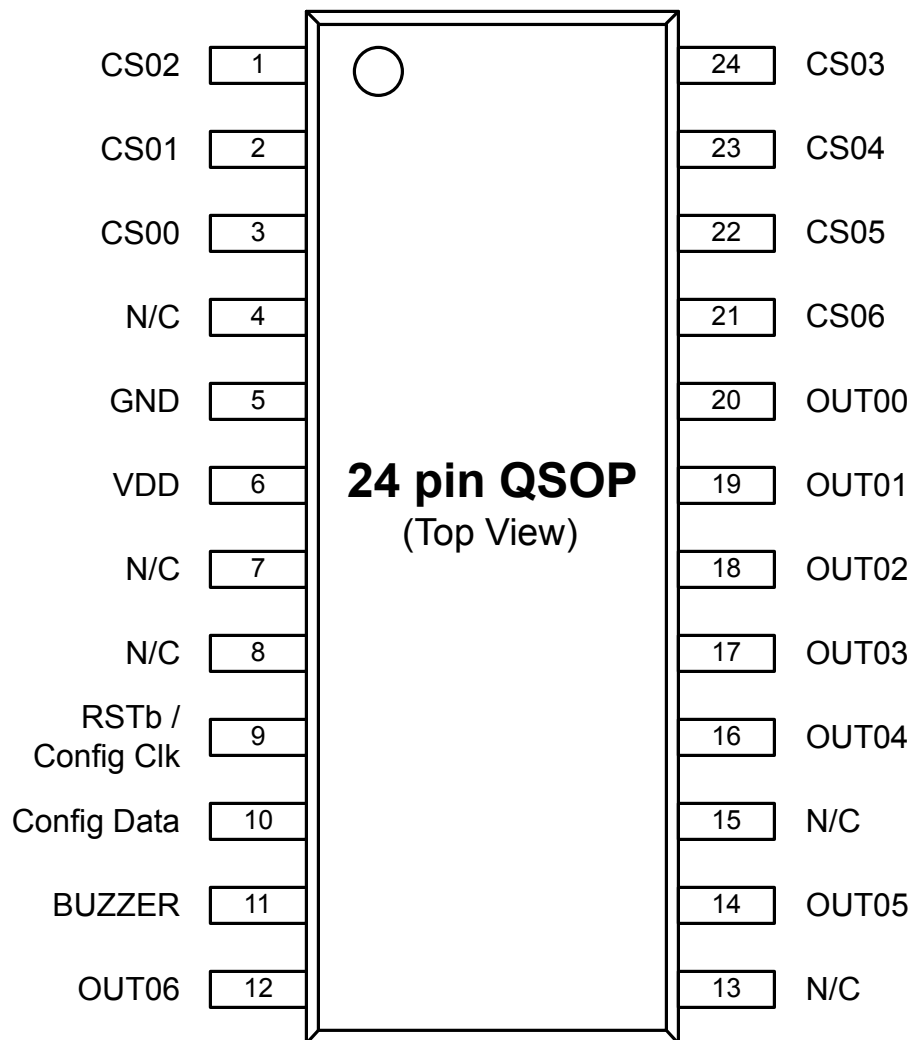


Figure 5.2. CPT007B QSOP24 Pinout

Table 5.2. Pin Definitions for CPT007B QSOP24

Pin Number	Pin Name	Description
1	CS02	Analog input Capacitive sensing input 2
2	CS01	Analog input Capacitive sensing input 1
3	CS00	Analog input Capacitive sensing input 0
4	N/C	No Connect (leave this pin floating)
5	GND	Ground



Pin Number	Pin Name	Description
6	VDD	Supply power input
7	N/C	No Connect (leave this pin floating)
8	N/C	No Connect (leave this pin floating)
9	RSTb / Config Clk	Active-low reset / Configuration clock
10	Config Data	Configuration data
11	Buzzer	Push-pull output Buzzer output
12	OUT06	Push-pull output Sensing state of CS06
13	N/C	No Connect (leave this pin floating)
14	OUT05	Push-pull output Sensing state of CS05
15	N/C	No Connect (leave this pin floating)
16	OUT04	Push-pull output Sensing state of CS04
17	OUT03	Push-pull output Sensing state of CS03
18	OUT02	Push-pull output Sensing state of CS02
19	OUT01	Push-pull output Sensing state of CS01
20	OUT00	Push-pull output Sensing state of CS00
21	CS06	Analog input Capacitive sensing input 6
22	CS05	Analog input Capacitive sensing input 5
23	CS04	Analog input Capacitive sensing input 4
24	CS03	Analog input Capacitive sensing input 3

## 6. QFN20 Package Specifications

### 6.1 QFN20 Package Dimensions

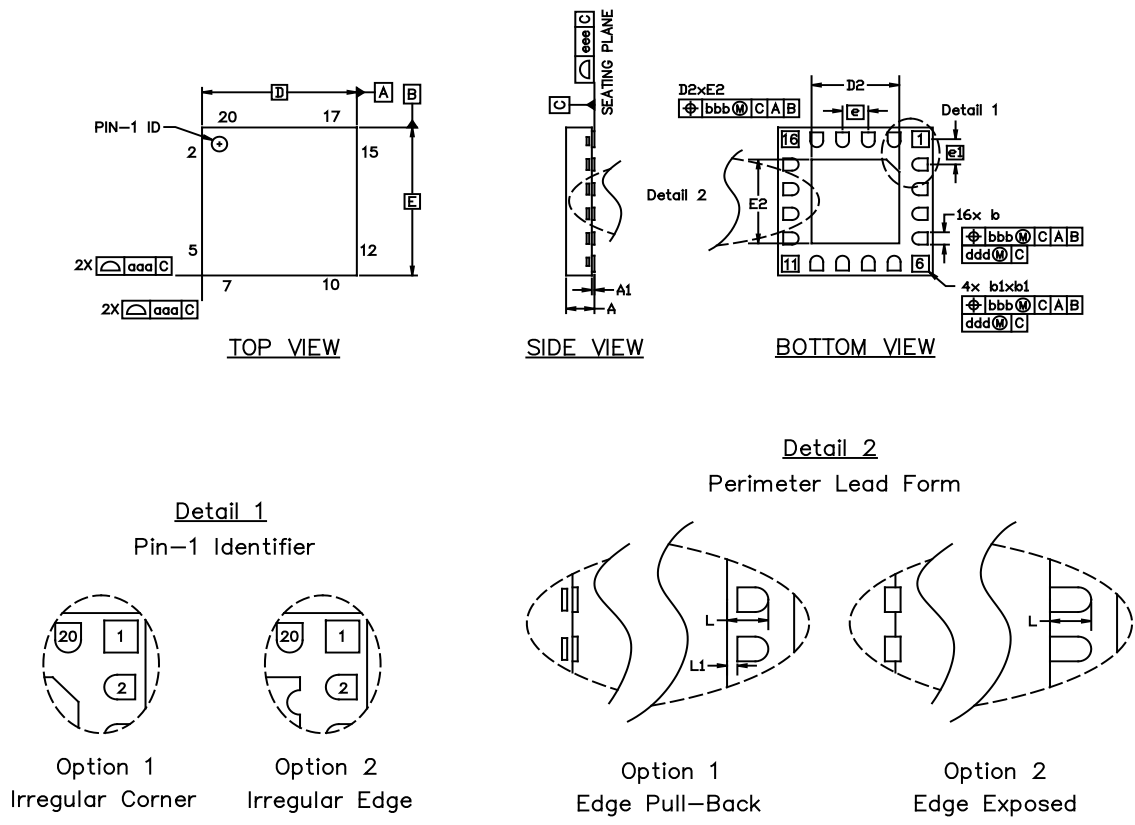


Figure 6.1. QFN20 Package Drawing

Table 6.1. QFN20 Package Dimensions

Dimension	Min	Typ	Max
A	0.50	0.55	0.60
A1	0.00	—	0.05
b	0.20	0.25	0.30
b1	0.275	0.325	0.375
D	3.00 BSC		
D2	1.6	1.70	1.80
e	0.50 BSC		
e1	0.513 BSC		
E	3.00 BSC		
E2	1.60	1.70	1.80
L	0.35	0.40	0.45

Dimension	Min	Typ	Max
L1	0.00	—	0.10
aaa	—	0.10	—
bbb	—	0.10	—
ddd	—	0.05	—
eee	—	—	0.08

**Note:**

1. All dimensions shown are in millimeters (mm) unless otherwise noted.
2. Dimensioning and Tolerancing per ANSI Y14.5M-1994.
3. This drawing is based upon JEDEC Solid State Product Outline MO-248 but includes custom features which are toleranced per supplier designation.
4. Recommended card reflow profile is per the JEDEC/IPC J-STD-020 specification for Small Body Components.

6.2 QFN20 PCB Land Pattern

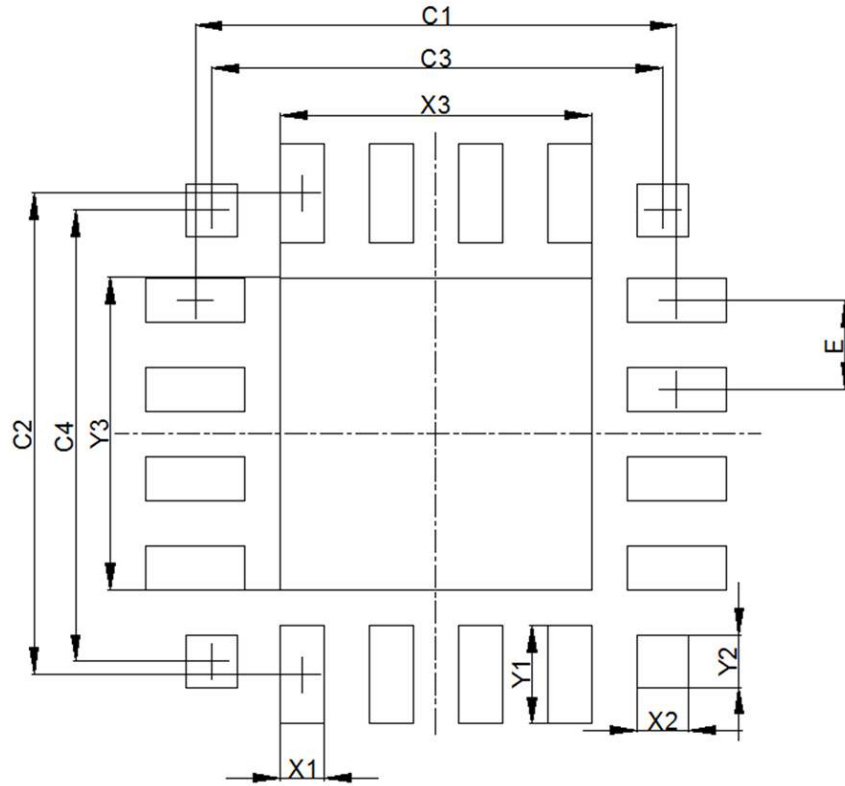


Figure 6.2. QFN20 PCB Land Pattern Drawing

Table 6.2. QFN20 PCB Land Pattern Dimensions

Dimension	Min	Max
C1		2.70
C2		2.70
C3		2.53
C4		2.53
E		0.50 REF
X1	0.20	0.30
X2	0.24	.034
X3	1.70	1.80
Y1	0.50	0.60
Y2	0.24	0.34
Y3	1.70	1.80

Dimension	Min	Max
<b>Note:</b> <ol style="list-style-type: none"><li>1. All dimensions shown are in millimeters (mm) unless otherwise noted.</li><li>2. Dimensioning and Tolerancing is per the ANSI Y14.5M-1994 specification.</li><li>3. This Land Pattern Design is based on the IPC-7351 guidelines.</li><li>4. All metal pads are to be non-solder mask defined (NSMD). Clearance between the solder mask and the metal pad is to be 60 µm minimum, all the way around the pad.</li><li>5. A stainless steel, laser-cut and electro-polished stencil with trapezoidal walls should be used to assure good solder paste release.</li><li>6. The stencil thickness should be 0.125 mm (5 mils).</li><li>7. The ratio of stencil aperture to land pad size should be 1:1 for the perimeter pads.</li><li>8. A 2x2 array of 0.75 mm openings on a 0.95 mm pitch should be used for the center pad to assure proper paste volume.</li><li>9. A No-Clean, Type-3 solder paste is recommended.</li><li>10. The recommended card reflow profile is per the JEDEC/IPC J-STD-020 specification for Small Body Components.</li></ol>		

### 6.3 QFN20 Package Marking

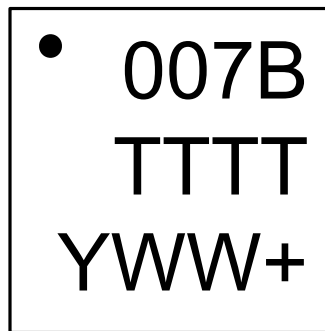


Figure 6.3. QFN20 Package Marking

The package marking consists of:

- 007B – The part number designation.
- TTTT – A trace or manufacturing code. The first letter of this code is the hardware revision.
- Y – The last digit of the assembly year.
- WW – The 2-digit workweek when the device was assembled.
- + – Indicates the device is RoHS-compliant.

## 7. QSOP24 Package Specifications

### 7.1 QSOP24 Package Dimensions

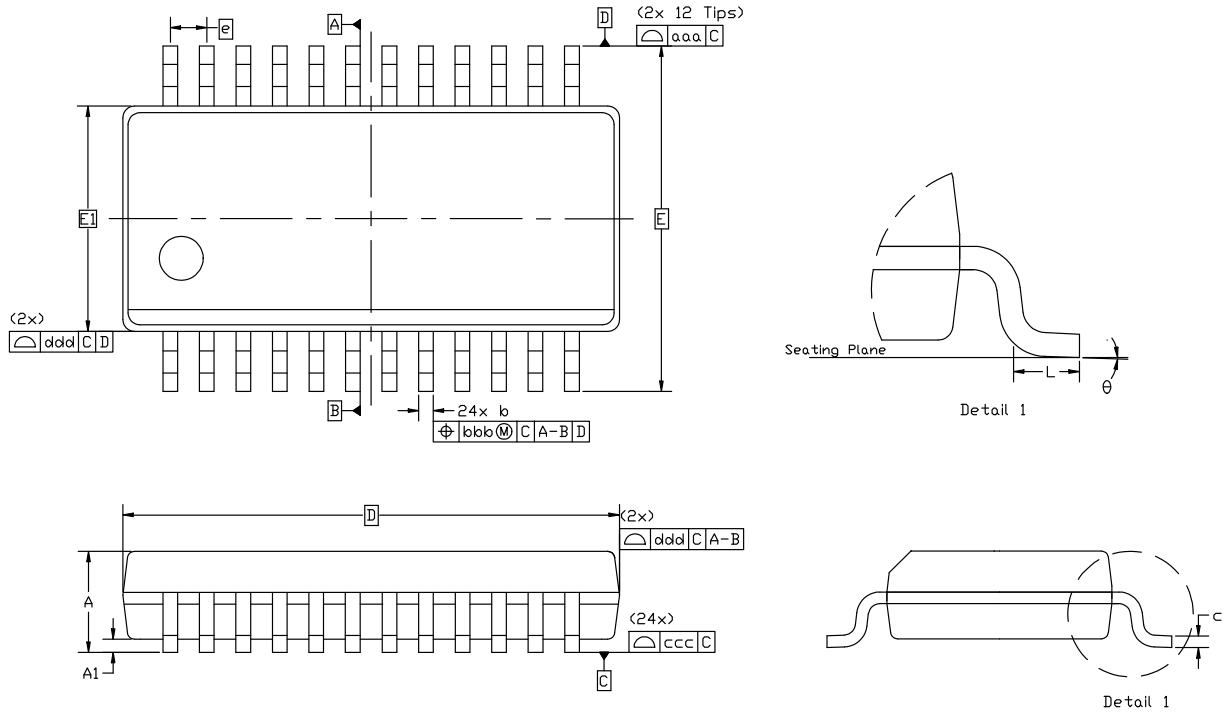


Figure 7.1. QSOP24 Package Drawing

Table 7.1. QSOP24 Package Dimensions

Dimension	Min	Typ	Max
A	—	—	1.75
A1	0.10	—	0.25
b	0.20	—	0.30
c	0.10	—	0.25
D	8.65 BSC		
E	6.00 BSC		
E1	3.90 BSC		
e	0.635 BSC		
L	0.40	—	1.27
theta	0°	—	8°

Dimension	Min	Typ	Max
aaa		0.20	
bbb		0.18	
ccc		0.10	
ddd		0.10	

**Note:**

1. All dimensions shown are in millimeters (mm) unless otherwise noted.
2. Dimensioning and Tolerancing per ANSI Y14.5M-1994.
3. This drawing conforms to JEDEC outline MO-137, variation AE.
4. Recommended card reflow profile is per the JEDEC/IPC J-STD-020 specification for Small Body Components.

## 7.2 QSOP24 PCB Land Pattern

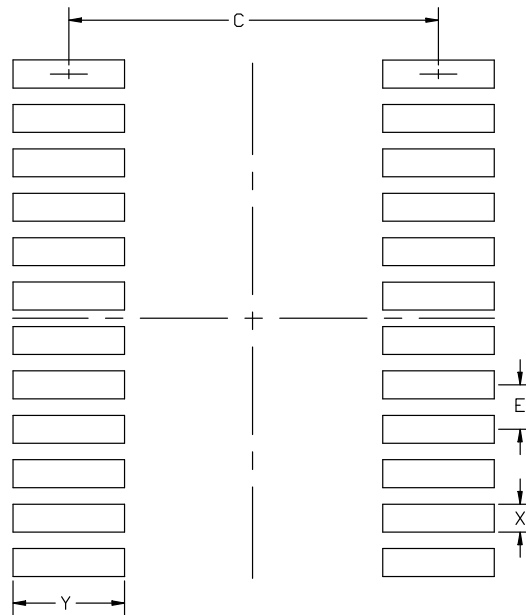


Figure 7.2. QSOP24 PCB Land Pattern Drawing

Table 7.2. QSOP24 PCB Land Pattern Dimensions

Dimension	Min	Max
C	5.20	5.30
E	0.635 BSC	
X	0.30	0.40
Y	1.50	1.60

**Note:**

1. All dimensions shown are in millimeters (mm) unless otherwise noted.
2. This land pattern design is based on the IPC-7351 guidelines.
3. All metal pads are to be non-solder mask defined (NSMD). Clearance between the solder mask and the metal pad is to be 60  $\mu\text{m}$  minimum, all the way around the pad.
4. A stainless steel, laser-cut and electro-polished stencil with trapezoidal walls should be used to assure good solder paste release.
5. The stencil thickness should be 0.125 mm (5 mils).
6. The ratio of stencil aperture to land pad size should be 1:1 for all perimeter pads.
7. A No-Clean, Type-3 solder paste is recommended.
8. The recommended card reflow profile is per the JEDEC/IPC J-STD-020 specification for Small Body Components.



### 7.3 QSOP24 Package Marking

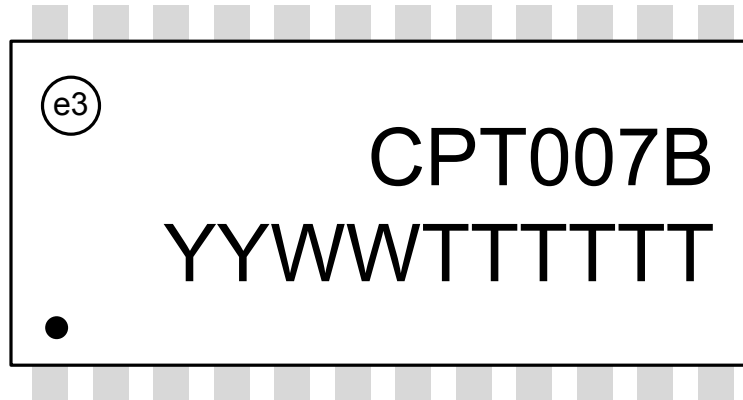


Figure 7.3. QSOP24 Package Marking

The package marking consists of:

- CPT007B – The part number designation.
- TTTTTT – A trace or manufacturing code. The first letter of this code is the hardware revision.
- YY – The last two digits of the assembly year.
- WW – The 2-digit workweek when the device was assembled.
- e3 – Indicates the device is RoHS-compliant.

## 8. Relevant Application Notes

The following Application Notes are applicable to the CPT007B devices:

- *AN957: TouchXpress™ Configuration and Profiling Guide* — This application note guides developers through the evaluation and configuration process of TouchXpress devices using Simplicity Studio [**Xpress Configurator**] and [**Capacitive Sense Profiler**].
- *AN447: Printed Circuit Design Notes for Capacitive Sensing Performance* — This document describes hardware design guidelines specifically for capacitive sensing applications, including button placement and other layout guidelines.
- *AN949: TouchXpress™ Programming Guide* — This application note discusses the production programming options available for TouchXpress devices.

Application Notes can be accessed on the Silicon Labs website ([www.silabs.com/interface-appnotes](http://www.silabs.com/interface-appnotes)) or in Simplicity Studio using the [**Application Notes**] tile.

## 9. Revision History

### 9.1 Revision 0.2

August 12th, 2016

Added new revision devices (A02).

Added QSOP24 devices, including pinout information and package drawings.

Added a paragraph to [4.1.12 Active Mode and Sleep Mode Transitions](#) describing the wake-on-touch behavior.

### 9.2 Revision 0.1

November 21st, 2015

Initial release.

---

# Table of Contents

<b>1. Feature List and Ordering Information</b>	<b>1</b>
<b>2. Typical Connection Diagrams</b>	<b>2</b>
2.1 Signal, Analog, and Power Connections	2
2.2 Configuration	3
<b>3. Electrical Specifications</b>	<b>4</b>
3.1 Electrical Characteristics	4
3.1.1 Recommended Operating Conditions	4
3.1.2 Power Consumption	5
3.1.3 Reset and Supply Monitor	6
3.1.4 Configuration Memory	6
3.1.5 Capacitive Sense	7
3.1.6 General Purpose and Buzzer Outputs	8
3.2 Thermal Conditions	8
3.3 Absolute Maximum Ratings	9
3.4 Typical Performance Curves	10
<b>4. Functional Description</b>	<b>13</b>
4.1 Capacitive Sensing Input	13
4.1.1 Introduction	13
4.1.2 Touch Qualification Criteria	13
4.1.3 Thresholds	13
4.1.4 Debounce Counter	14
4.1.5 Touch Deltas	14
4.1.6 Auto-Accumulation and Averaging	14
4.1.7 Drive strength	14
4.1.8 Active Mode Scan Enable	14
4.1.9 Active Mode Scan Period	14
4.1.10 Active Mode Scan Type	15
4.1.11 Sleep Mode Scan Period	15
4.1.12 Active Mode and Sleep Mode Transitions	16
4.2 Pin Output	16
4.2.1 Introduction	16
4.2.2 Configuration	17
4.3 Capacitive Proximity Sensing	17
4.3.1 Wake on Proximity	17
4.3.2 Proximity Sensing Output	17
4.3.3 Proximity Configuration	17
4.4 Touch Time-Out	17
4.5 Buzzer Output	17
4.5.1 Introduction	17
4.5.2 Buzzer Configuration	18
4.6 Mutually Exclusive Buttons	18

---

4.7 Self Testing . . . . .	.19
4.7.1 Introduction . . . . .	.19
4.7.2 Test Failure Signaling . . . . .	.19
4.8 Configuration Profile. . . . .	.20
<b>5. Pin Definitions . . . . .</b>	<b>21</b>
5.1 CPT007B QFN20 Pin Definitions . . . . .	.21
5.2 CPT007B QSOP24 Pin Definitions . . . . .	.23
<b>6. QFN20 Package Specifications. . . . .</b>	<b>25</b>
6.1 QFN20 Package Dimensions . . . . .	.25
6.2 QFN20 PCB Land Pattern . . . . .	.27
6.3 QFN20 Package Marking . . . . .	.28
<b>7. QSOP24 Package Specifications . . . . .</b>	<b>29</b>
7.1 QSOP24 Package Dimensions . . . . .	.29
7.2 QSOP24 PCB Land Pattern . . . . .	.31
7.3 QSOP24 Package Marking . . . . .	.32
<b>8. Relevant Application Notes . . . . .</b>	<b>33</b>
<b>9. Revision History . . . . .</b>	<b>34</b>
9.1 Revision 0.2 . . . . .	.34
9.2 Revision 0.1 . . . . .	.34
<b>Table of Contents . . . . .</b>	<b>35</b>

Silicon Labs

# Simplicity Studio™4



## Simplicity Studio

One-click access to MCU and wireless tools, documentation, software, source code libraries & more. Available for Windows, Mac and Linux!



IoT Portfolio  
[www.silabs.com/IoT](http://www.silabs.com/IoT)



SW/HW  
[www.silabs.com/simplicity](http://www.silabs.com/simplicity)



Quality  
[www.silabs.com/quality](http://www.silabs.com/quality)



Support and Community  
[community.silabs.com](http://community.silabs.com)

### Disclaimer

Silicon Laboratories intends to provide customers with the latest, accurate, and in-depth documentation of all peripherals and modules available for system and software implementers using or intending to use the Silicon Laboratories products. Characterization data, available modules and peripherals, memory sizes and memory addresses refer to each specific device, and "Typical" parameters provided can and do vary in different applications. Application examples described herein are for illustrative purposes only. Silicon Laboratories reserves the right to make changes without further notice and limitation to product information, specifications, and descriptions herein, and does not give warranties as to the accuracy or completeness of the included information. Silicon Laboratories shall have no liability for the consequences of use of the information supplied herein. This document does not imply or express copyright licenses granted hereunder to design or fabricate any integrated circuits. The products are not designed or authorized to be used within any Life Support System without the specific written consent of Silicon Laboratories. A "Life Support System" is any product or system intended to support or sustain life and/or health, which, if it fails, can be reasonably expected to result in significant personal injury or death. Silicon Laboratories products are not designed or authorized for military applications. Silicon Laboratories products shall under no circumstances be used in weapons of mass destruction including (but not limited to) nuclear, biological or chemical weapons, or missiles capable of delivering such weapons.

### Trademark Information

Silicon Laboratories Inc.®, Silicon Laboratories®, Silicon Labs®, SiLabs® and the Silicon Labs logo®, Bluegiga®, Bluegiga Logo®, Clockbuilder®, CMEMS®, DSPLL®, EFM®, EFM32®, EFR®, Ember®, Energy Micro, Energy Micro logo and combinations thereof, "the world's most energy friendly microcontrollers", Ember®, EZLink®, EZRadio®, EZRadioPRO®, Gecko®, ISOModem®, Precision32®, ProSLIC®, Simplicity Studio®, SIPHY®, Telegesis, the Telegesis Logo®, USBXpress® and others are trademarks or registered trademarks of Silicon Laboratories Inc. ARM, CORTEX, Cortex-M3 and THUMB are trademarks or registered trademarks of ARM Holdings. Keil is a registered trademark of ARM Limited. All other products or brand names mentioned herein are trademarks of their respective holders.



Silicon Laboratories Inc.  
400 West Cesar Chavez  
Austin, TX 78701  
USA

<http://www.silabs.com>