

General information

Part number	K10LOC-P07LCC0-3200
Termination	solder
Size	0
Locking principle	break , push
Coding	0_key
Cable Diameter	cable_mini_32
Cable outlet	standard

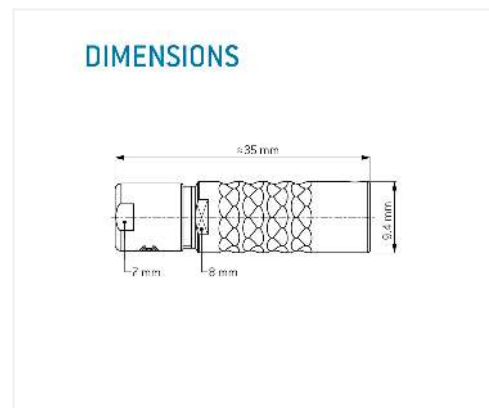
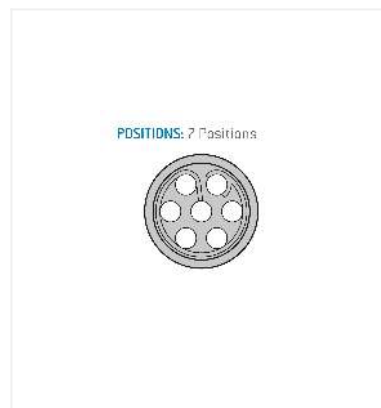

Contact insert description

Number of contacts	7
Contact type	sockets
Contact diameter	05mm
Insulator material	peek
Wire cross section	28_awg
Termination	solder
Termination diameter	04mm

reverse_gender_on_request

Technical information

Max. creepage and air clearance distance	07_mm	08_mm
Nominal current single contact	04_a	iec_60512_5_2
Nominal current insert	2,6 A	vde_0298_4
Test voltage	09_kv_ac	sae_13441

safety_text

Mechanical and environmental data

Degree of protection*	ip50
-----------------------	------

Operating temperature	40_120_c
-----------------------	----------

Mating cycles	5000
---------------	------

mated_unmated

Material and surface treatments

Housing	m_chrome
---------	----------

Contact	cu_alloy_gold
---------	---------------

safety_text_2

ul_text

illustrative_text