

## 9-Bit Odd/Even Parity Generator/Checker

### Features

- **Buffered Inputs**
- **Typical Propagation Delay**
  - 10ns at  $V_{CC} = 5V$ ,  $T_A = 25^\circ C$ ,  $C_L = 50pF$
- **Exceeds 2kV ESD Protection per MIL-STD-883, Method 3015**
- **SCR-Latchup-Resistant CMOS Process and Circuit Design**
- **Speed of Bipolar FAST™/AS/S with Significantly Reduced Power Consumption**
- **Balanced Propagation Delays**
- **AC Types Feature 1.5V to 5.5V Operation and Balanced Noise Immunity at 30% of the Supply**
- **±24mA Output Drive Current**
  - Fanout to 15 FAST™ ICs
  - Drives 50Ω Transmission Lines

### Description

The 'AC280 and 'ACT280 are 9-bit odd/even parity generator/checkers that utilize Advanced CMOS Logic technology. Both even and odd parity outputs are available for checking or generating parity for words up to nine bits long. Even parity is indicated ( $\Sigma E$  output is HIGH) when an even number of

data inputs is HIGH. Odd parity is indicated ( $\Sigma O$  output is HIGH) when an odd number of data inputs is HIGH. Parity checking for words larger than nine bits can be accomplished by tying the  $\Sigma E$  output to any input of an additional 'AC280, 'ACT280 parity checker.

### Ordering Information

PART NUMBER	TEMP. RANGE (°C)	PACKAGE
CD54AC280F3A	-55 to 125	14 Ld CERDIP
CD74AC280E	0 to 70°C, -40 to 85, -55 to 125	14 Ld PDIP
CD74AC280M	0 to 70°C, -40 to 85, -55 to 125	14 Ld SOIC
CD54ACT280F3A	-55 to 125	14 Ld CERDIP
CD74ACT280E	0 to 70°C, -40 to 85, -55 to 125	14 Ld PDIP
CD74ACT280M	0 to 70°C, -40 to 85, -55 to 125	14 Ld SOIC

#### NOTES:

1. When ordering, use the entire part number. Add the suffix 96 to obtain the variant in the tape and reel.
2. Wafer and die for this part number is available which meets all electrical specifications. Please contact your local TI sales office or customer service for ordering information.

### Pinout

CD54AC280, CD54ACT280  
(CERDIP)  
CD74AC280, CD74ACT280  
(PDIP, SOIC)  
TOP VIEW

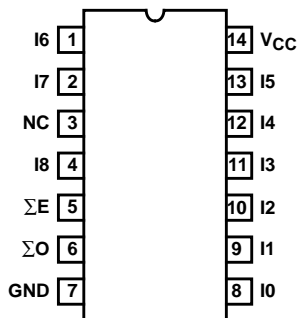

### Functional Diagram

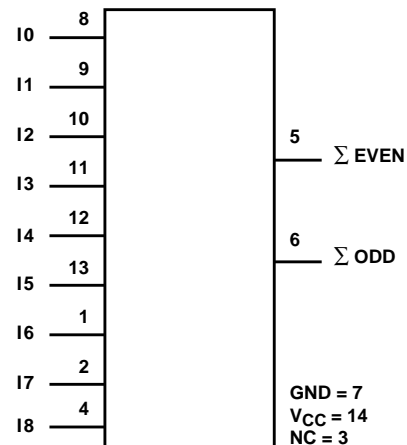

## CD54/74AC280, CD54/74ACT280

### Absolute Maximum Ratings

DC Supply Voltage, $V_{CC}$ .....	-0.5V to 6V
DC Input Diode Current, $I_{IK}$	
For $V_I < -0.5V$ or $V_I > V_{CC} + 0.5V$ .....	$\pm 20mA$
DC Output Diode Current, $I_{OK}$	
For $V_O < -0.5V$ or $V_O > V_{CC} + 0.5V$ .....	$\pm 50mA$
DC Output Source or Sink Current per Output Pin, $I_O$	
For $V_O > -0.5V$ or $V_O < V_{CC} + 0.5V$ .....	$\pm 50mA$
DC $V_{CC}$ or Ground Current, $I_{CC}$ or $I_{GND}$ (Note 3) .....	$\pm 100mA$

### Thermal Information

Thermal Resistance (Typical, Note 5)	$\theta_{JA}$ ( $^{\circ}C/W$ )
PDIP Package .....	—
SOIC Package .....	—
Maximum Junction Temperature (Plastic Package) .....	$150^{\circ}C$
Maximum Storage Temperature Range .....	$-65^{\circ}C$ to $150^{\circ}C$
Maximum Lead Temperature (Soldering 10s) .....	$300^{\circ}C$

### Operating Conditions

Temperature Range, $T_A$ .....	$-55^{\circ}C$ to $125^{\circ}C$
Supply Voltage Range, $V_{CC}$ (Note 4)	
AC Types .....	1.5V to 5.5V
ACT Types .....	4.5V to 5.5V
DC Input or Output Voltage, $V_I$ , $V_O$ .....	0V to $V_{CC}$
Input Rise and Fall Slew Rate, dt/dv	
AC Types, 1.5V to 3V .....	50ns (Max)
AC Types, 3.6V to 5.5V .....	20ns (Max)
ACT Types, 4.5V to 5.5V .....	10ns (Max)

*CAUTION: Stresses above those listed in "Absolute Maximum Ratings" may cause permanent damage to the device. This is a stress only rating and operation of the device at these or any other conditions above those indicated in the operational sections of this specification is not implied.*

#### NOTES:

3. For up to 4 outputs per device, add  $\pm 25mA$  for each additional output.
4. Unless otherwise specified, all voltages are referenced to ground.
5.  $\theta_{JA}$  is measured with the component mounted on an evaluation PC board in free air.

### DC Electrical Specifications

PARAMETER	SYMBOL	TEST CONDITIONS		$V_{CC}$ (V)	25 $^{\circ}C$		-40 $^{\circ}C$ TO 85 $^{\circ}C$		-55 $^{\circ}C$ TO 125 $^{\circ}C$		UNITS	
		$V_I$ (V)	$I_O$ (mA)		MIN	MAX	MIN	MAX	MIN	MAX		
<b>AC TYPES</b>												
High Level Input Voltage	$V_{IH}$	-	-	1.5	1.2	-	1.2	-	1.2	-	V	
				3	2.1	-	2.1	-	2.1	-	V	
				5.5	3.85	-	3.85	-	3.85	-	V	
Low Level Input Voltage	$V_{IL}$	-	-	1.5	-	0.3	-	0.3	-	0.3	V	
				3	-	0.9	-	0.9	-	0.9	V	
				5.5	-	1.65	-	1.65	-	1.65	V	
High Level Output Voltage	$V_{OH}$	$V_{IH}$ or $V_{IL}$	-0.05	-0.05	1.5	1.4	-	1.4	-	1.4	-	V
			-0.05	-0.05	3	2.9	-	2.9	-	2.9	-	V
			-0.05	-0.05	4.5	4.4	-	4.4	-	4.4	-	V
			-4	-4	3	2.58	-	2.48	-	2.4	-	V
			-24	-24	4.5	3.94	-	3.8	-	3.7	-	V
			-75 (Note 6, 7)	-75 (Note 6, 7)	5.5	-	-	3.85	-	-	-	V
			-50 (Note 6, 7)	-50 (Note 6, 7)	5.5	-	-	-	-	3.85	-	V

**CD54/74AC280, CD54/74ACT280**

**DC Electrical Specifications (Continued)**

PARAMETER	SYMBOL	TEST CONDITIONS		V <sub>CC</sub> (V)	25°C		-40°C TO 85°C		-55°C TO 125°C		UNITS
		V <sub>I</sub> (V)	I <sub>O</sub> (mA)		MIN	MAX	MIN	MAX	MIN	MAX	
Low Level Output Voltage	V <sub>OL</sub>	V <sub>IH</sub> or V <sub>IL</sub>	0.05	1.5	-	0.1	-	0.1	-	0.1	V
			0.05	3	-	0.1	-	0.1	-	0.1	V
			0.05	4.5	-	0.1	-	0.1	-	0.1	V
			12	3	-	0.36	-	0.44	-	0.5	V
			24	4.5	-	0.36	-	0.44	-	0.5	V
			75 (Note 6, 7)	5.5	-	-	-	1.65	-	-	V
			50 (Note 6, 7)	5.5	-	-	-	-	-	1.65	V
Input Leakage Current	I <sub>I</sub>	V <sub>CC</sub> or GND	-	5.5	-	±0.1	-	±1	-	±1	μA
Quiescent Supply Current MSI	I <sub>CC</sub>	V <sub>CC</sub> or GND	0	5.5	-	8	-	80	-	160	μA
<b>ACT TYPES</b>											
High Level Input Voltage	V <sub>IH</sub>	-	-	4.5 to 5.5	2	-	2	-	2	-	V
Low Level Input Voltage	V <sub>IL</sub>	-	-	4.5 to 5.5	-	0.8	-	0.8	-	0.8	V
High Level Output Voltage	V <sub>OH</sub>	V <sub>IH</sub> or V <sub>IL</sub>	-0.05	4.5	4.4	-	4.4	-	4.4	-	V
			-24	4.5	3.94	-	3.8	-	3.7	-	V
			-75 (Note 6, 7)	5.5	-	-	3.85	-	-	-	V
			-50 (Note 6, 7)	5.5	-	-	-	-	3.85	-	V
Low Level Output Voltage	V <sub>OL</sub>	V <sub>IH</sub> or V <sub>IL</sub>	0.05	4.5	-	0.1	-	0.1	-	0.1	V
			24	4.5	-	0.36	-	0.44	-	0.5	V
			75 (Note 6, 7)	5.5	-	-	-	1.65	-	-	V
			50 (Note 6, 7)	5.5	-	-	-	-	-	1.65	V
Input Leakage Current	I <sub>I</sub>	V <sub>CC</sub> or GND	-	5.5	-	±0.1	-	±1	-	±1	μA
Quiescent Supply Current MSI	I <sub>CC</sub>	V <sub>CC</sub> or GND	0	5.5	-	8	-	80	-	160	μA
Additional Supply Current per Input Pin TTL Inputs High 1 Unit Load	ΔI <sub>CC</sub>	V <sub>CC</sub> -2.1	-	4.5 to 5.5	-	2.4	-	2.8	-	3	mA

**NOTES:**

- Test one output at a time for a 1-second maximum duration. Measurement is made by forcing current and measuring voltage to minimize power dissipation.
- Test verifies a minimum 50Ω transmission-line-drive capability at 85°C, 75Ω at 125°C.

**ACT Input Load Table**

INPUT	UNIT LOAD
All	1.43

NOTE: Unit load is ΔI<sub>CC</sub> limit specified in DC Electrical Specifications Table, e.g., 2.4mA max at 25°C.

## CD54/74AC280, CD54/74ACT280

### Switching Specifications Input $t_r, t_f = 3\text{ns}$ , $C_L = 50\text{pF}$ (Worst Case)

PARAMETER	SYMBOL	$V_{CC}$ (V)	-40°C TO 85°C			-55°C TO 125°C			UNITS
			MIN	TYP	MAX	MIN	TYP	MAX	
<b>AC TYPES</b>									
Propagation Delay, Any Input to $\Sigma O$	$t_{PLH}, t_{PHL}$	1.5	-	-	239	-	-	263	ns
		3.3 (Note 9)	7.5	-	26	7.3	-	29	ns
		5 (Note 10)	5.4	-	19.1	5.3	-	21	ns
Propagation Delay, Any Input to $\Sigma E$	$t_{PLH}, t_{PHL}$	1.5	-	-	227	-	-	250	ns
		3.3	7.2	-	25	7	-	28	ns
		5	5.2	-	18.2	5	-	20	ns
Input Capacitance	$C_I$	-	-	-	10	-	-	10	pF
Power Dissipation Capacitance	$C_{PD}$ (Note 11)	-	-	115	-	-	115	-	pF
<b>ACT TYPES</b>									
Propagation Delay, Any Input to $\Sigma O$	$t_{PLH}, t_{PHL}$	5 (Note 10)	5.6	-	19.6	5.4	-	21.6	ns
Propagation Delay, Any Input to $\Sigma E$	$t_{PLH}, t_{PHL}$	5	5.6	-	19.6	5.4	-	21.6	ns
Input Capacitance	$C_I$	-	-	-	10	-	-	10	pF
Power Dissipation Capacitance	$C_{PD}$ (Note 11)	-	-	115	-	-	115	-	pF

**NOTES:**

8. Limits tested 100%
9. 3.3V Min is at 3.6V, Max is at 3V.
10. 5V Min is at 5.5V, Max is at 4.5V.
11.  $C_{PD}$  is used to determine the dynamic power consumption per package.  
 AC:  $P_D = V_{CC}^2 f_i (C_{PD} + C_L)$   
 ACT:  $P_D = V_{CC}^2 f_i (C_{PD} + C_L) + V_{CC} \Delta I_{CC}$  where  $f_i$  = input frequency,  $C_L$  = output load capacitance,  $V_{CC}$  = supply voltage.

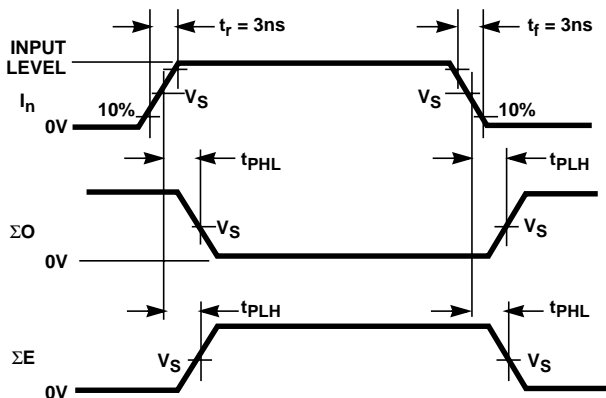

**FIGURE 1.**

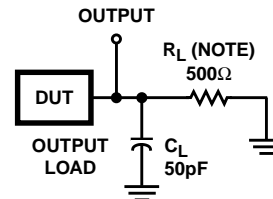

NOTE: For AC Series Only: When  $V_{CC} = 1.5\text{V}$ ,  $R_L = 1\text{k}\Omega$ .

	AC	ACT
Input Level	$V_{CC}$	3V
Input Switching Voltage, $V_S$	$0.5 V_{CC}$	1.5V
Output Switching Voltage, $V_S$	$0.5 V_{CC}$	$0.5 V_{CC}$

**FIGURE 2. PROPAGATION DELAY TIMES**

**PACKAGING INFORMATION**

Orderable Device	Status (1)	Package Type	Package Drawing	Pins	Package Qty	Eco Plan (2)	Lead finish/ Ball material (6)	MSL Peak Temp (3)	Op Temp (°C)	Device Marking (4/5)	Samples
CD54AC280F3A	ACTIVE	CDIP	J	14	1	Non-RoHS & Green	SNPB	N / A for Pkg Type	-55 to 125	CD54AC280F3A	<a href="#">Samples</a>
CD54ACT280F3A	ACTIVE	CDIP	J	14	1	Non-RoHS & Green	SNPB	N / A for Pkg Type	-55 to 125	CD54ACT280F3A	<a href="#">Samples</a>
CD74AC280E	ACTIVE	PDIP	N	14	25	RoHS & Green	NIPDAU	N / A for Pkg Type	-55 to 125	CD74AC280E	<a href="#">Samples</a>
CD74AC280M	ACTIVE	SOIC	D	14	50	RoHS & Green	NIPDAU	Level-1-260C-UNLIM	-55 to 125	AC280M	<a href="#">Samples</a>
CD74AC280M96	ACTIVE	SOIC	D	14	2500	RoHS & Green	NIPDAU	Level-1-260C-UNLIM	-55 to 125	AC280M	<a href="#">Samples</a>
CD74AC280M96G4	ACTIVE	SOIC	D	14	2500	RoHS & Green	NIPDAU	Level-1-260C-UNLIM	-55 to 125	AC280M	<a href="#">Samples</a>
CD74ACT280E	ACTIVE	PDIP	N	14	25	RoHS & Green	NIPDAU	N / A for Pkg Type	-55 to 125	CD74ACT280E	<a href="#">Samples</a>
CD74ACT280M	ACTIVE	SOIC	D	14	50	RoHS & Green	NIPDAU	Level-1-260C-UNLIM	-55 to 125	ACT280M	<a href="#">Samples</a>
CD74ACT280M96	ACTIVE	SOIC	D	14	2500	RoHS & Green	NIPDAU	Level-1-260C-UNLIM	-55 to 125	ACT280M	<a href="#">Samples</a>

(1) The marketing status values are defined as follows:

**ACTIVE:** Product device recommended for new designs.

**LIFEBUY:** TI has announced that the device will be discontinued, and a lifetime-buy period is in effect.

**NRND:** Not recommended for new designs. Device is in production to support existing customers, but TI does not recommend using this part in a new design.

**PREVIEW:** Device has been announced but is not in production. Samples may or may not be available.

**OBSOLETE:** TI has discontinued the production of the device.

(2) **RoHS:** TI defines "RoHS" to mean semiconductor products that are compliant with the current EU RoHS requirements for all 10 RoHS substances, including the requirement that RoHS substance do not exceed 0.1% by weight in homogeneous materials. Where designed to be soldered at high temperatures, "RoHS" products are suitable for use in specified lead-free processes. TI may reference these types of products as "Pb-Free".

**RoHS Exempt:** TI defines "RoHS Exempt" to mean products that contain lead but are compliant with EU RoHS pursuant to a specific EU RoHS exemption.

**Green:** TI defines "Green" to mean the content of Chlorine (Cl) and Bromine (Br) based flame retardants meet JS709B low halogen requirements of <=1000ppm threshold. Antimony trioxide based flame retardants must also meet the <=1000ppm threshold requirement.

(3) MSL, Peak Temp. - The Moisture Sensitivity Level rating according to the JEDEC industry standard classifications, and peak solder temperature.

(4) There may be additional marking, which relates to the logo, the lot trace code information, or the environmental category on the device.

(5) Multiple Device Markings will be inside parentheses. Only one Device Marking contained in parentheses and separated by a "-" will appear on a device. If a line is indented then it is a continuation of the previous line and the two combined represent the entire Device Marking for that device.

(6) Lead finish/Ball material - Orderable Devices may have multiple material finish options. Finish options are separated by a vertical ruled line. Lead finish/Ball material values may wrap to two lines if the finish value exceeds the maximum column width.

**Important Information and Disclaimer:**The information provided on this page represents TI's knowledge and belief as of the date that it is provided. TI bases its knowledge and belief on information provided by third parties, and makes no representation or warranty as to the accuracy of such information. Efforts are underway to better integrate information from third parties. TI has taken and continues to take reasonable steps to provide representative and accurate information but may not have conducted destructive testing or chemical analysis on incoming materials and chemicals. TI and TI suppliers consider certain information to be proprietary, and thus CAS numbers and other limited information may not be available for release.

In no event shall TI's liability arising out of such information exceed the total purchase price of the TI part(s) at issue in this document sold by TI to Customer on an annual basis.

**OTHER QUALIFIED VERSIONS OF CD54AC280, CD54ACT280, CD74AC280, CD74ACT280 :**

- Catalog : [CD74AC280](#), [CD74ACT280](#)
- Military : [CD54AC280](#), [CD54ACT280](#)

NOTE: Qualified Version Definitions:

- Catalog - TI's standard catalog product
- Military - QML certified for Military and Defense Applications

**TAPE AND REEL INFORMATION**

**QUADRANT ASSIGNMENTS FOR PIN 1 ORIENTATION IN TAPE**

\*All dimensions are nominal

Device	Package Type	Package Drawing	Pins	SPQ	Reel Diameter (mm)	Reel Width W1 (mm)	A0 (mm)	B0 (mm)	K0 (mm)	P1 (mm)	W (mm)	Pin1 Quadrant
CD74AC280M96	SOIC	D	14	2500	330.0	16.4	6.5	9.0	2.1	8.0	16.0	Q1
CD74ACT280M96	SOIC	D	14	2500	330.0	16.4	6.5	9.0	2.1	8.0	16.0	Q1

**TAPE AND REEL BOX DIMENSIONS**

\*All dimensions are nominal

Device	Package Type	Package Drawing	Pins	SPQ	Length (mm)	Width (mm)	Height (mm)
CD74AC280M96	SOIC	D	14	2500	356.0	356.0	35.0
CD74ACT280M96	SOIC	D	14	2500	356.0	356.0	35.0



**TUBE**

\*All dimensions are nominal

Device	Package Name	Package Type	Pins	SPQ	L (mm)	W (mm)	T (μm)	B (mm)
CD74AC280E	N	PDIP	14	25	506	13.97	11230	4.32
CD74AC280E	N	PDIP	14	25	506	13.97	11230	4.32
CD74AC280M	D	SOIC	14	50	506.6	8	3940	4.32
CD74ACT280E	N	PDIP	14	25	506	13.97	11230	4.32
CD74ACT280E	N	PDIP	14	25	506	13.97	11230	4.32
CD74ACT280M	D	SOIC	14	50	506.6	8	3940	4.32

J 14

**GENERIC PACKAGE VIEW**  
**CDIP - 5.08 mm max height**  
CERAMIC DUAL IN LINE PACKAGE



Images above are just a representation of the package family, actual package may vary.  
Refer to the product data sheet for package details.

4040083-5/G

J0014A



# PACKAGE OUTLINE

CDIP - 5.08 mm max height

CERAMIC DUAL IN LINE PACKAGE



4214771/A 05/2017

NOTES:

1. All controlling linear dimensions are in inches. Dimensions in brackets are in millimeters. Any dimension in brackets or parenthesis are for reference only. Dimensioning and tolerancing per ASME Y14.5M.
2. This drawing is subject to change without notice.
3. This package is hermetically sealed with a ceramic lid using glass frit.
4. Index point is provided on cap for terminal identification only and on press ceramic glass frit seal only.
5. Falls within MIL-STD-1835 and GDIP1-T14.

# EXAMPLE BOARD LAYOUT

J0014A

CDIP - 5.08 mm max height

CERAMIC DUAL IN LINE PACKAGE



LAND PATTERN EXAMPLE  
NON-SOLDER MASK DEFINED  
SCALE: 5X





4214771/A 05/2017

D (R-PDSO-G14)

PLASTIC SMALL OUTLINE



- NOTES:
- A. All linear dimensions are in inches (millimeters).
  - B. This drawing is subject to change without notice.
  -  Body length does not include mold flash, protrusions, or gate burrs. Mold flash, protrusions, or gate burrs shall not exceed 0.006 (0,15) each side.
  -  Body width does not include interlead flash. Interlead flash shall not exceed 0.017 (0,43) each side.
  - E. Reference JEDEC MS-012 variation AB.

D (R-PDSO-G14)

PLASTIC SMALL OUTLINE

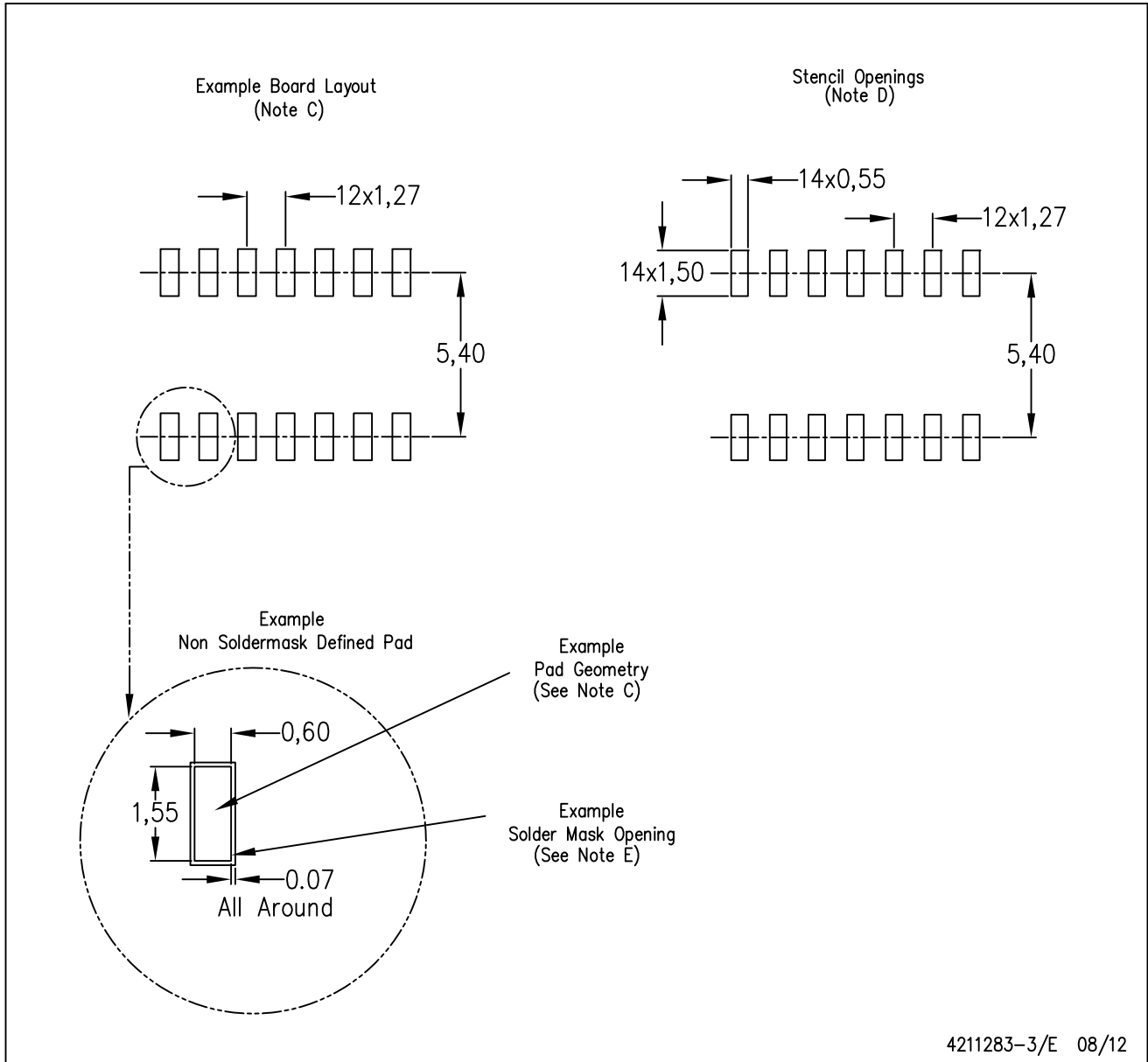

- NOTES:
- A. All linear dimensions are in millimeters.
  - B. This drawing is subject to change without notice.
  - C. Publication IPC-7351 is recommended for alternate designs.
  - D. Laser cutting apertures with trapezoidal walls and also rounding corners will offer better paste release. Customers should contact their board assembly site for stencil design recommendations. Refer to IPC-7525 for other stencil recommendations.
  - E. Customers should contact their board fabrication site for solder mask tolerances between and around signal pads.

N (R-PDIP-T\*\*)

PLASTIC DUAL-IN-LINE PACKAGE

16 PINS SHOWN



- NOTES:
- A. All linear dimensions are in inches (millimeters).
  - B. This drawing is subject to change without notice.
  - Falls within JEDEC MS-001, except 18 and 20 pin minimum body length (Dim A).
  - The 20 pin end lead shoulder width is a vendor option, either half or full width.

## IMPORTANT NOTICE AND DISCLAIMER

TI PROVIDES TECHNICAL AND RELIABILITY DATA (INCLUDING DATA SHEETS), DESIGN RESOURCES (INCLUDING REFERENCE DESIGNS), APPLICATION OR OTHER DESIGN ADVICE, WEB TOOLS, SAFETY INFORMATION, AND OTHER RESOURCES "AS IS" AND WITH ALL FAULTS, AND DISCLAIMS ALL WARRANTIES, EXPRESS AND IMPLIED, INCLUDING WITHOUT LIMITATION ANY IMPLIED WARRANTIES OF MERCHANTABILITY, FITNESS FOR A PARTICULAR PURPOSE OR NON-INFRINGEMENT OF THIRD PARTY INTELLECTUAL PROPERTY RIGHTS.

These resources are intended for skilled developers designing with TI products. You are solely responsible for (1) selecting the appropriate TI products for your application, (2) designing, validating and testing your application, and (3) ensuring your application meets applicable standards, and any other safety, security, regulatory or other requirements.

These resources are subject to change without notice. TI grants you permission to use these resources only for development of an application that uses the TI products described in the resource. Other reproduction and display of these resources is prohibited. No license is granted to any other TI intellectual property right or to any third party intellectual property right. TI disclaims responsibility for, and you will fully indemnify TI and its representatives against, any claims, damages, costs, losses, and liabilities arising out of your use of these resources.

TI's products are provided subject to [TI's Terms of Sale](#) or other applicable terms available either on [ti.com](http://ti.com) or provided in conjunction with such TI products. TI's provision of these resources does not expand or otherwise alter TI's applicable warranties or warranty disclaimers for TI products.

TI objects to and rejects any additional or different terms you may have proposed.

Mailing Address: Texas Instruments, Post Office Box 655303, Dallas, Texas 75265  
Copyright © 2022, Texas Instruments Incorporated