

GaAs MMIC VOLTAGE - VARIABLE ATTENUATOR, 10 - 40 GHz

Typical Applications

The HMC985ALP4KE is ideal for:

- Point-to-Point Radio
- VSAT Radio
- Test Instrumentation
- Microwave Sensors
- Military, ECM & Radar

Features

- Wide Bandwidth: 10 - 40 GHz
- Excellent Linearity: +32 dB Input IP3
- Wide Attenuation Range: 35 dB
- No External Matching
- 24 Lead 4x4 mm SMT Package: 16 mm²

Functional Diagram

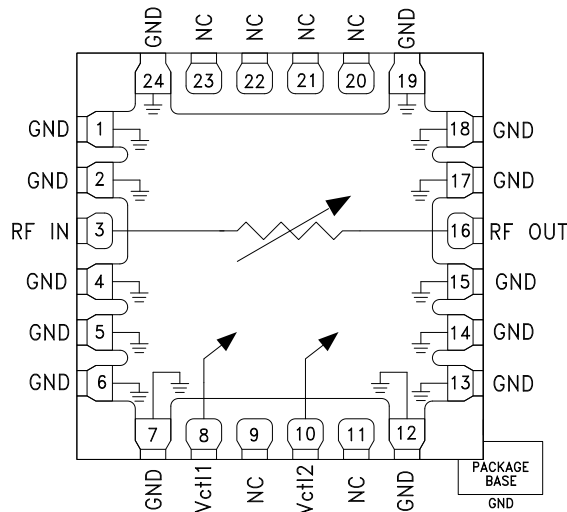

General Description

The HMC985ALP4KE is an absorptive Voltage Variable Attenuator (VVA) which operates from 10 - 40 GHz and is ideal in designs where an analog DC control signal must be used to control RF signal levels over a 35 dB dynamic range. It features two shunt-type attenuators which are controlled by two analog voltages, Vctl1 and Vctl2. Optimum linearity performance of the attenuator is achieved by first varying Vctl1 of the first attenuation stage from -5V to 0V with Vctl2 fixed at -5V. The control voltage of the second attenuation stage, Vctl2, should then be varied from -5V to 0V with Vctl1 fixed at 0V.

If the Vctl1 and Vctl2 pins are connected together it is possible to achieve the full analog attenuation range with only a small degradation in input IP3 performance. Applications include AGC circuits and temperature compensation of multiple gain stages in microwave point-to-point and VSAT radios.

Electrical Specifications, $T_A = +25^\circ\text{C}$, Test Condition $V_{ctl1} = V_{ctl2}$

Parameter	Frequency	Min.	Typ.	Max.	Units
Insertion Loss [1]	10 - 20 GHz		3.1	3.9	dB
	20 - 30 GHz		2.1	3.5	dB
	30 - 40 GHz		2.9	4.0	dB
Attenuation Range	10 - 20 GHz	25	30		dB
	20 - 30 GHz	30	39		dB
	30 - 40 GHz	35	42		dB
Input Return Loss	10 - 40 GHz		13		dB
Output Return Loss	10 - 40 GHz		13		dB
Input Third Order Intercept (two-tone input Power = 10 dBm Each Tone) [2]			32		dBm

[1] Vctl1 = Vctl2 = -4V

[2] Vctl1 = Vctl2 = -3.4V worst case

GaAs MMIC VOLTAGE - VARIABLE ATTENUATOR, 10 - 40 GHz

Attenuation vs. Frequency over Vctl1 = Variable, Vctl2 = -5V

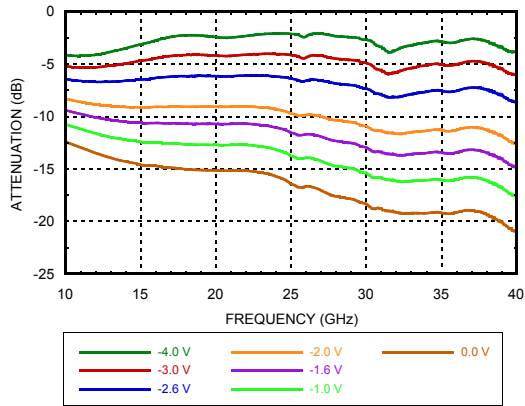

Attenuation vs. Frequency over Vctl1 = 0V, Vctl2 = Variable

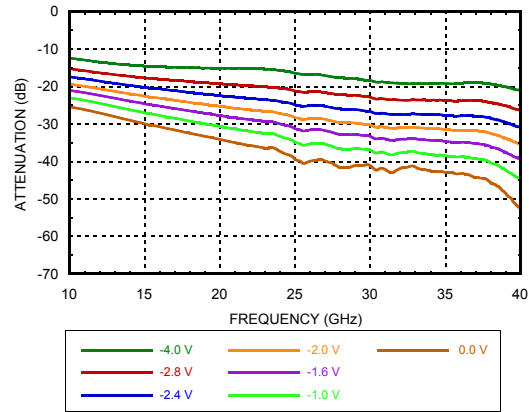

Attenuation vs. Vctl1 Over Temperature @ 25 GHz, Vctl2 = -5V

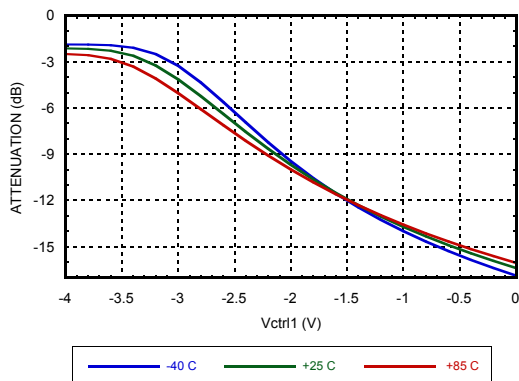

Attenuation vs. Vctl2 Over Temperature @ 30 GHz, Vctl1 = 0V

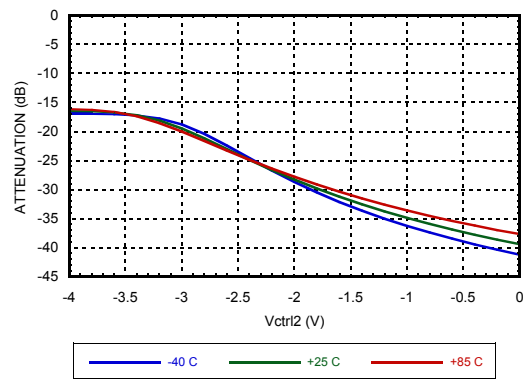

Attenuation vs. Pin @ 20 GHz over Vctl1 Variable, Vctl2 = -3V

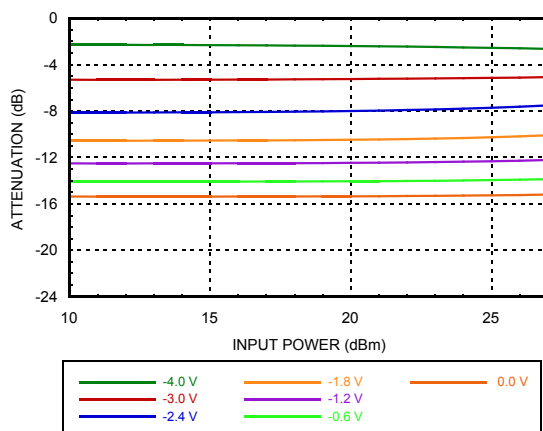

Attenuation vs. Pin @ 20 GHz over Vctl2 Variable, Vctl1 = 0V

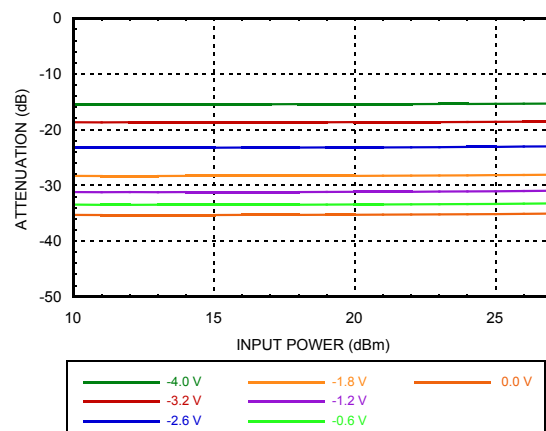

GaAs MMIC VOLTAGE - VARIABLE ATTENUATOR, 10 - 40 GHz

Input Return Loss
Vctl1 = Variable, Vctl2 = -5V

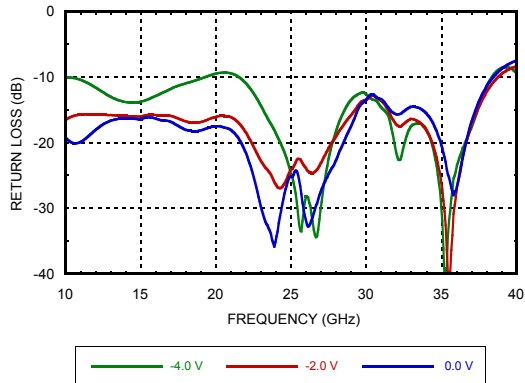

Input Return Loss
Vctl1 = 0V, Vctl2 = Variable

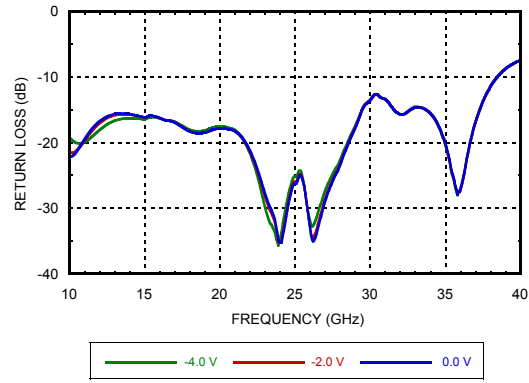

Output Return Loss
Vctl1 = Variable, Vctl2 = -5V

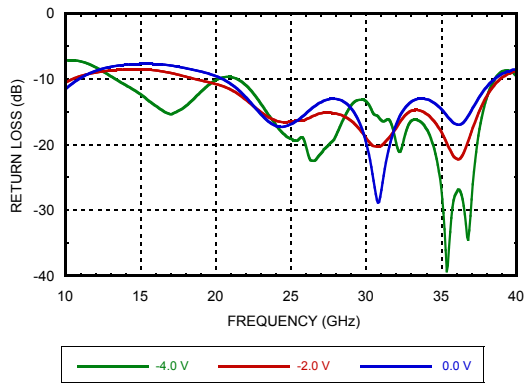

Output Return Loss
Vctl1 = 0V, Vctl2 = Variable

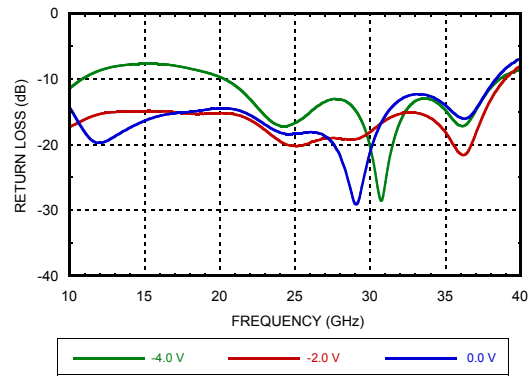

Input IP3 vs. Input Power @ 20 GHz
Vctl1 = Variable, Vctl2 = -5V

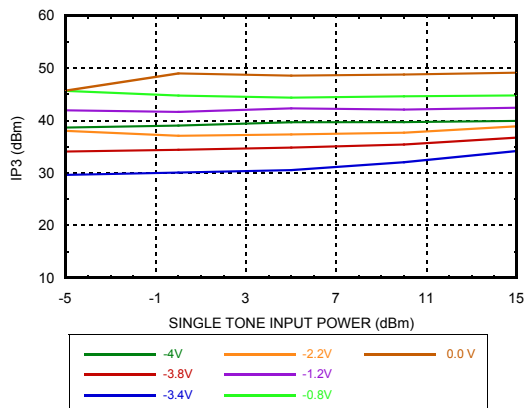

Input IP3 vs. Input Power Over Frequency
Vctl1 = -3.2V, Vctl2 = -5V [1]

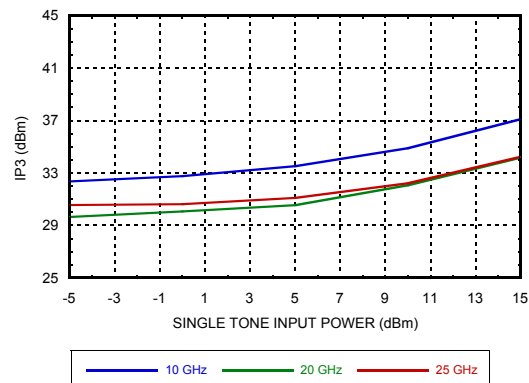

[1] Worst Case IP3

**GaAs MMIC VOLTAGE - VARIABLE
ATTENUATOR, 10 - 40 GHz**

**Input IP3 vs. Input Power Over Temperature
@ 20 GHz, Vctl1 = -3.4V, Vctl2 = -5V [1]**

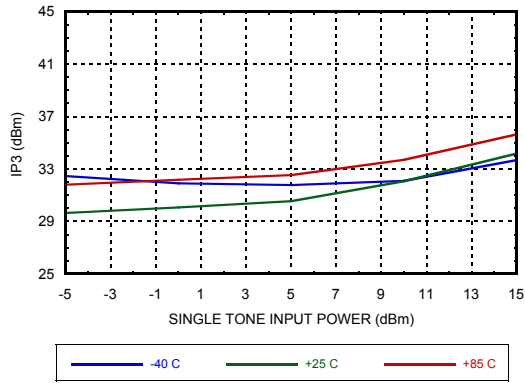

**Input IP3 vs. Input Power @ 20 GHz
Vctl2 = Variable, Vctl1 = 0V**

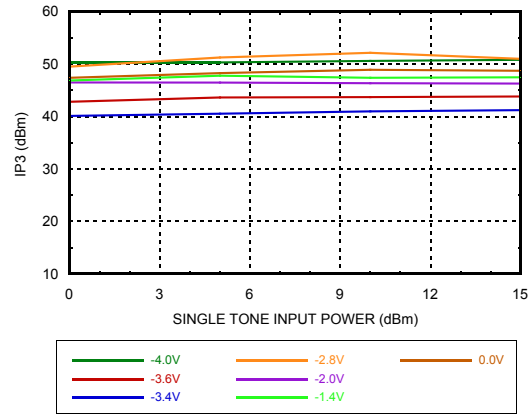

**Input IP3 vs. Input Power Over Frequency
Vctl2 = -3.4V, Vctl1 = 0V [1]**

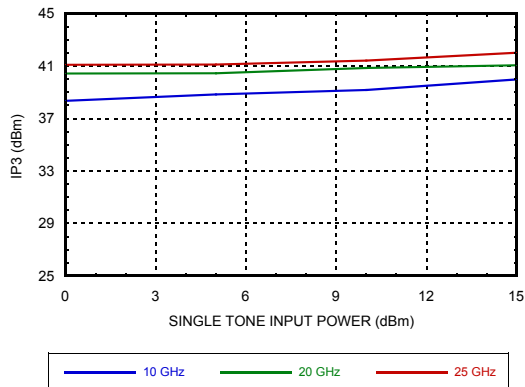

**Input IP3 vs Input Power over Temperature
@ 20 GHz, Vctl2 = -3.4V, Vctl1 = 0V [1]**

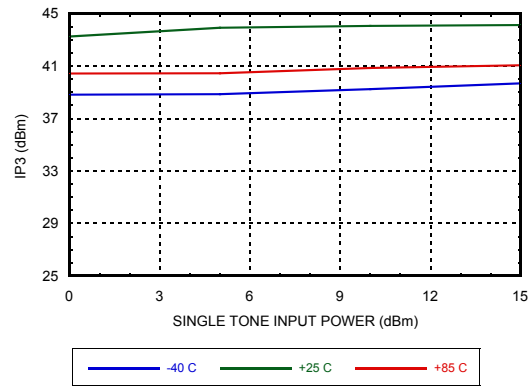

[1] Worst Case IP3

GaAs MMIC VOLTAGE - VARIABLE ATTENUATOR, 10 - 40 GHz

Attenuation vs Frequency Over Vctrl
Vctrl1 = Vctrl2

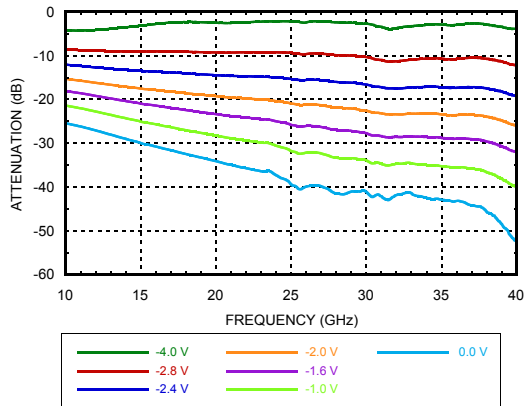

Attenuation vs. Vctrl Over Temperature
@ 20 GHz, Vctrl1 = Vctrl2

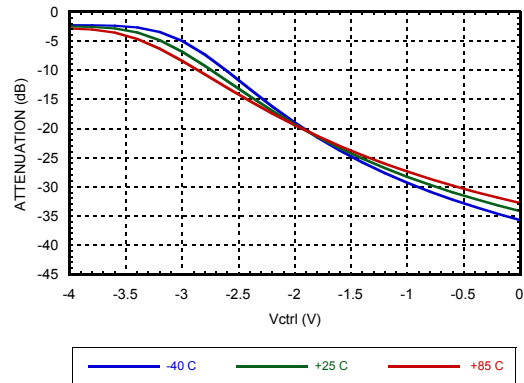

Attenuation vs. Pin @ 20 GHz Over Vctrl
Vctrl1 = Vctrl2

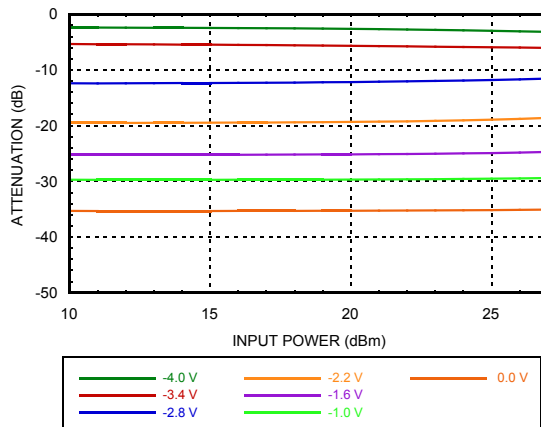

Input Return Loss, Vctrl1 = Vctrl2

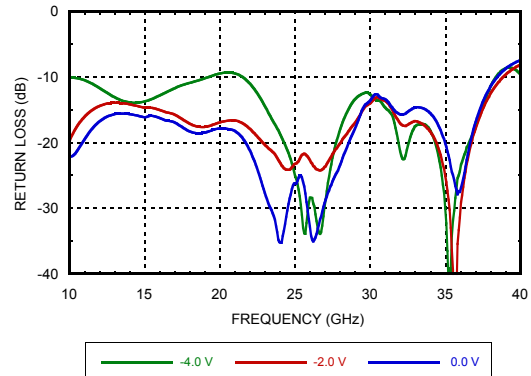

Output Return Loss, Vctrl1 = Vctrl2

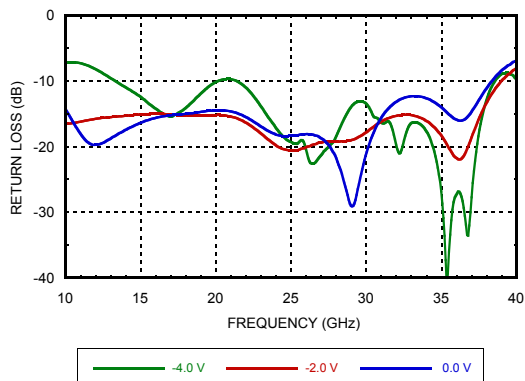

Input IP3 vs. Input Power Over Vctrl @ 20 GHz, Vctrl1 = Vctrl2

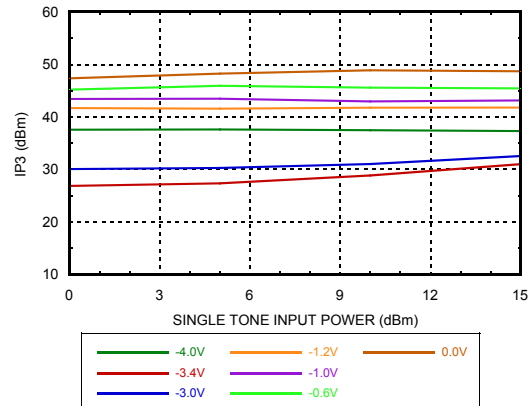

**GaAs MMIC VOLTAGE - VARIABLE
ATTENUATOR, 10 - 40 GHz**

Input IP3 vs. Input Power Over Frequency
Vctl1 = Vctl2

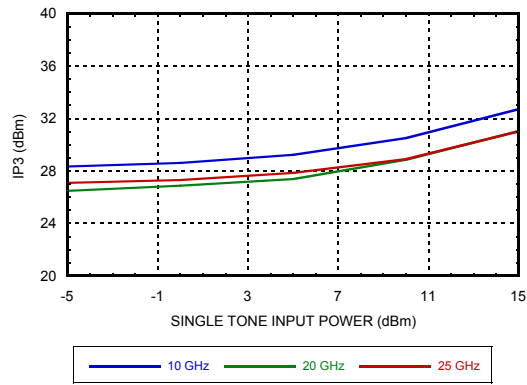

**Input IP3 vs. Input Power Over
Temperature @ 20 GHz** Vctl1 = Vctl2

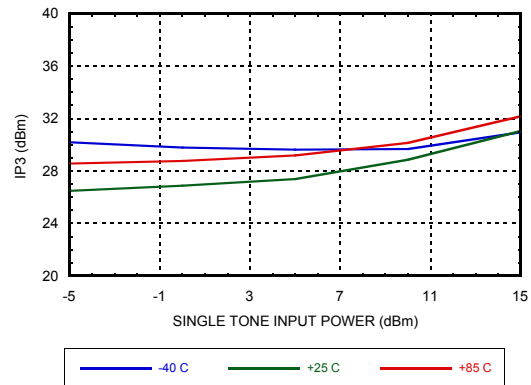

GaAs MMIC VOLTAGE - VARIABLE ATTENUATOR, 10 - 40 GHz

Absolute Maximum Ratings

Control Voltage	+0.3 to -6.0V
Input RF Power	30 dBm
Maximum Junction Temperature	175 °C
Thermal Resistance (R _{TH}) (junction to ground paddle)	65 °C/W
Operating Temperature	-40°C to +85°C
Storage Temperature	-65°C to 150°C
ESD Sensitivity (HBM)	Class1B

Control Voltages

Vctrl1 ^[1]	-5V to 0V @ 10uA, typical
Vctrl2 ^[1]	-5V to 0V @ 10uA, typical

[1] Vctrl1 = Vctrl2 = -4.0V



ELECTROSTATIC SENSITIVE DEVICE
OBSERVE HANDLING PRECAUTIONS

Outline Drawing

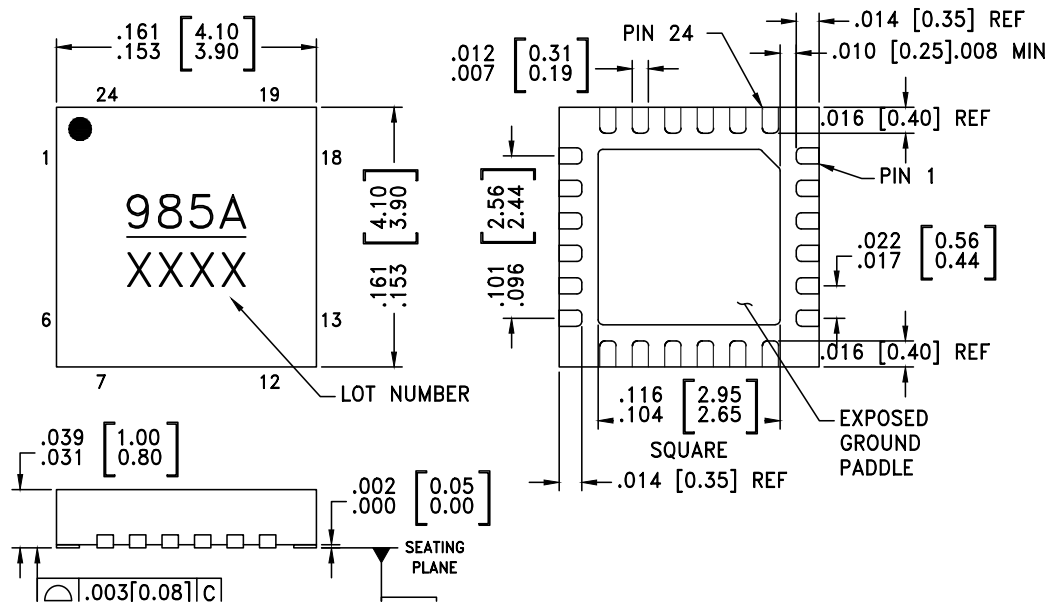

NOTES:

1. PACKAGE BODY MATERIAL: LOW STRESS INJECTION MOLDED PLASTIC SILICA AND SILICON IMPREGNATED.
2. LEAD AND GROUND PADDLE MATERIAL: COPPER ALLOY.
3. LEAD AND GROUND PADDLE PLATING: 100% MATTE TIN
4. DIMENSIONS ARE IN INCHES [MILLIMETERS].
5. LEAD SPACING TOLERANCE IS NON-CUMULATIVE.
6. CHARACTERS TO BE HELVETICA MEDIUM, .025 HIGH, WHITE INK, OR LASER MARK LOCATED APPROX. AS SHOWN.
7. PAD BURR LENGTH SHALL BE 0.15mm MAX. PAD BURR HEIGHT SHALL BE 0.05mm MAX.
8. PACKAGE WARP SHALL NOT EXCEED 0.05mm
9. ALL GROUND LEADS AND GROUND PADDLE MUST BE SOLDERED TO PCB RF GROUND.
10. REFER TO HITTITE APPLICATION NOTE FOR SUGGESTED PCB LAND PATTERN.

Package Information

Part Number	Package Body Material	Lead Finish	MSL Rating	Package Marking
HMC985ALP4KE	RoHS-compliant Low Stress Injection Molded Plastic	100% matte Sn	MSL3 ^[1]	985A XXXX

[1] Max peak reflow temperature of 260 °C

[2] 4-Digit lot number XXXX

GaAs MMIC VOLTAGE - VARIABLE ATTENUATOR, 10 - 40 GHz

Pin Descriptions

Pin Number	Function	Description	Pin Schematic
1, 2, 4-7, 12-15, 17-19, 24	GND	These pins and package bottom must be connected to RF/DC ground externally.	
3	RFIN	This pad is DC coupled and matched to 50 Ohms.	
8	Vctl1	Control Voltage 1.	
9, 11, 20-23	NC	These pins are not connected internally, however all data shown herein was measured with these pins connected to RF/DC ground externally.	
10	Vctl2	Control Voltage 2.	
16	RFOUT	This pad is DC coupled and matched to 50 Ohms.	

Assembly Diagram

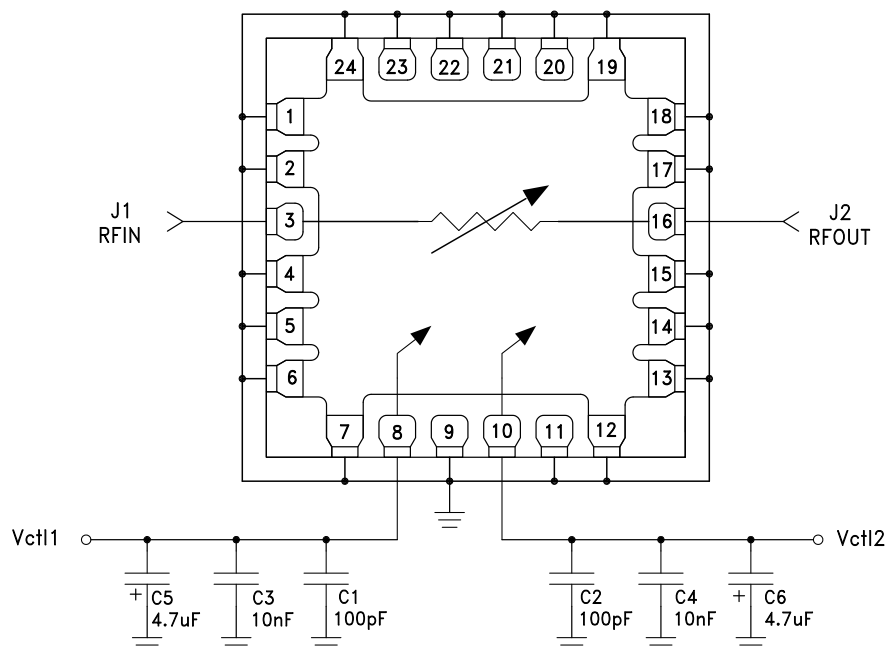

**GaAs MMIC VOLTAGE - VARIABLE
ATTENUATOR, 10 - 40 GHz**

Evaluation PCB

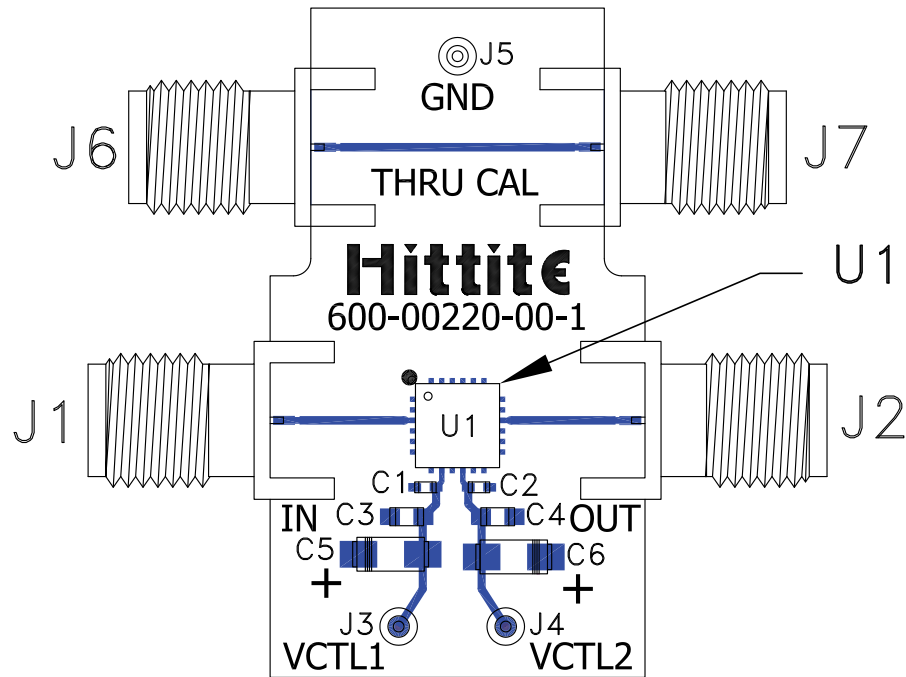

List of Materials for Evaluation PCB EV1HMC985ALP4K [1]

Item	Description
J1-J2, J6-J7	K Connectors.
J3-J5	DC Pins.
C1-C2	100pF Capacitors, 0402 Pkg.
C3-C4	0.01 μ F Capacitor, 0603 Pkg.
C5-C6	4.7 μ F Case A, Tantalum.
U1	HMC985ALP4KE VVA.
PCB	600-00220-00 Evaluation PCB.

[1] Reference this number when ordering complete evaluation PCB

The circuit board used in the final application should use RF circuit design techniques. Signal lines should have 50 Ohm impedance while the package ground leads and exposed paddle should be connected directly to the ground plane similar to that shown. A sufficient number of via holes should be used to connect the top and bottom ground planes. The evaluation circuit board shown is available from Analog Devices upon request.

**GaAs MMIC VOLTAGE - VARIABLE
ATTENUATOR, 10 - 40 GHz****Notes:**