

MC 1,5/ 6-G-3,5 - PCB header



1844252

<https://www.phoenixcontact.com/us/products/1844252>

Please be informed that the data shown in this PDF document is generated from our online catalog. Please find the complete data in the user documentation. Our general terms of use for downloads are valid.



PCB headers, nominal cross section: 1.5 mm², color: green, nominal current: 8 A, rated voltage (III/2): 160 V, contact surface: Tin, contact connection type: Pin, number of potentials: 6, number of rows: 1, number of positions: 6, number of connections: 6, product range: MC 1,5/...-G, pitch: 3.5 mm, mounting: Wave soldering, pin layout: Linear pinning, solder pin [P]: 3.4 mm, number of solder pins per potential: 1, plug-in system: COMBICON MC 1,5, Pin connector pattern alignment: Standard, locking: without, mounting: without, type of packaging: packed in cardboard

Your advantages

- Well-known mounting principle allows worldwide use
- Maximum flexibility when it comes to device design – one header for connectors with different connection technologies

Commercial data

Item number	1844252
Packing unit	1 pc
Minimum order quantity	100 pc
Sales key	AA02
Product key	AABSAA
Catalog page	Page 224 (C-1-2013)
GTIN	4017918113292
Weight per piece (including packing)	1.648 g
Weight per piece (excluding packing)	1.5 g
Customs tariff number	85366930
Country of origin	DE

MC 1,5/ 6-G-3,5 - PCB header



1844252

<https://www.phoenixcontact.com/us/products/1844252>

Technical data

Product properties

Type	Standard
Product line	COMBICON Connectors S
Product type	PCB headers
Product family	MC 1,5/...-G
Number of positions	6
Pitch	3.5 mm
Number of connections	6
Number of rows	1
Mounting flange	without
Number of potentials	6
Pin layout	Linear pinning
Solder pins per potential	1

Electrical properties

Nominal current I_N	8 A
Nominal voltage U_N	160 V
Degree of pollution	3
Contact resistance	1.3 m Ω
Rated voltage (III/3)	160 V
Rated surge voltage (III/3)	2.5 kV
Rated voltage (III/2)	160 V
Rated surge voltage (III/2)	2.5 kV
Rated voltage (II/2)	250 V
Rated surge voltage (II/2)	2.5 kV

Mounting

Mounting type	Wave soldering
Pin layout	Linear pinning

Material specifications

Material data - contact

Note	WEEE/RoHS-compliant, free of whiskers according to IEC 60068-2-82/JEDEC JESD 201
Contact material	Cu alloy
Surface characteristics	Tin-plated
Metal surface contact area (top layer)	Tin (3 - 5 μm Sn)
Metal surface contact area (middle layer)	Nickel (1.3 - 3 μm Ni)
Metal surface soldering area (top layer)	Tin (3 - 5 μm Sn)
Metal surface soldering area (middle layer)	Nickel (1.3 - 3 μm Ni)

Material data - housing

MC 1,5/ 6-G-3,5 - PCB header

1844252

<https://www.phoenixcontact.com/us/products/1844252>

Color (Housing)	green (6021)
Insulating material	PBT
Insulating material group	IIIa
CTI according to IEC 60112	225
Flammability rating according to UL 94	V0

Dimensions

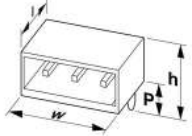
Dimensional drawing	
Pitch	3.5 mm
Width [w]	22.4 mm
Height [h]	10.65 mm
Length [l]	9.2 mm
Installed height	7.25 mm
Solder pin length [P]	3.4 mm
Pin dimensions	0.8 x 0.8 mm

Mechanical tests

Visual inspection

Specification	IEC 60512-1-1:2002-02
Result	Test passed

Dimension check

Specification	IEC 60512-1-2:2002-02
Result	Test passed

Resistance of inscriptions

Specification	IEC 60068-2-70:1995-12
Result	Test passed

Polarization and coding

Specification	IEC 60512-13-5:2006-02
Result	Test passed

Contact holder in insert

Specification	IEC 60512-15-1:2008-05
Contact holder in insert Requirements >20 N	Test passed

Insertion and withdrawal forces

Result	Test passed
No. of cycles	25
Insertion strength per pos. approx.	6 N

MC 1,5/ 6-G-3,5 - PCB header



1844252

<https://www.phoenixcontact.com/us/products/1844252>

Withdraw strength per pos. approx.	4 N
------------------------------------	-----

Electrical tests

Thermal test | Test group C

Specification	IEC 60512-5-1:2002-02
Tested number of positions	20

Insulation resistance

Specification	IEC 60512-3-1:2002-02
Insulation resistance, neighboring positions	> 5 MΩ

Air clearances and creepage distances |

Specification	IEC 60664-1:2007-04
Insulating material group	IIIa
Comparative tracking index (IEC 60112)	CTI 225
Rated insulation voltage (III/3)	160 V
Rated surge voltage (III/3)	2.5 kV
minimum clearance value - non-homogenous field (III/3)	1.5 mm
minimum creepage distance (III/3)	2.5 mm
Rated insulation voltage (III/2)	160 V
Rated surge voltage (III/2)	2.5 kV
minimum clearance value - non-homogenous field (III/2)	1.5 mm
minimum creepage distance (III/2)	1.6 mm
Rated insulation voltage (II/2)	250 V
Rated surge voltage (II/2)	2.5 kV
minimum clearance value - non-homogenous field (II/2)	1.5 mm
minimum creepage distance (II/2)	2.5 mm

Environmental and real-life conditions

Vibration test

Specification	IEC 60068-2-6:2007-12
Frequency	10 - 150 - 10 Hz
Sweep speed	1 octave/min
Amplitude	0.35 mm (10 Hz ... 60.1 Hz)
Sweep speed	5g (60.1 Hz ... 150 Hz)
Test duration per axis	2.5 h

Durability test

Specification	IEC 60512-9-1:2010-03
Impulse withstand voltage at sea level	2.95 kV
Contact resistance R ₁	1.3 mΩ
Contact resistance R ₂	1.4 mΩ
Insertion/withdrawal cycles	25
Insulation resistance, neighboring positions	> 5 MΩ

MC 1,5/ 6-G-3,5 - PCB header



1844252

<https://www.phoenixcontact.com/us/products/1844252>

Climatic test

Specification	ISO 6988:1985-02
Corrosive stress	0.2 dm ³ SO ₂ on 300 dm ³ /40 °C/1 cycle
Thermal stress	100 °C/168 h
Power-frequency withstand voltage	1.39 kV

Ambient conditions

Ambient temperature (operation)	-40 °C ... 100 °C (dependent on the derating curve)
Ambient temperature (storage/transport)	-40 °C ... 70 °C
Relative humidity (storage/transport)	30 % ... 70 %
Ambient temperature (assembly)	-5 °C ... 100 °C

Packaging specifications

Type of packaging	packed in cardboard
-------------------	---------------------

Drawings

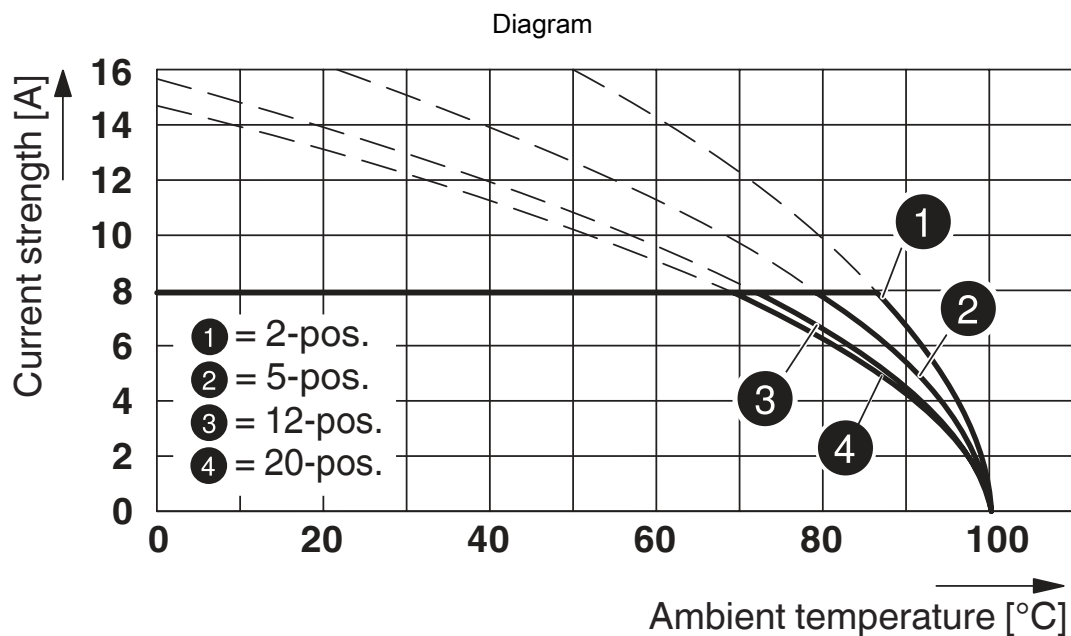

Type: MC 1,5/...-ST-3,5 with MC 1,5/...-G-3,5

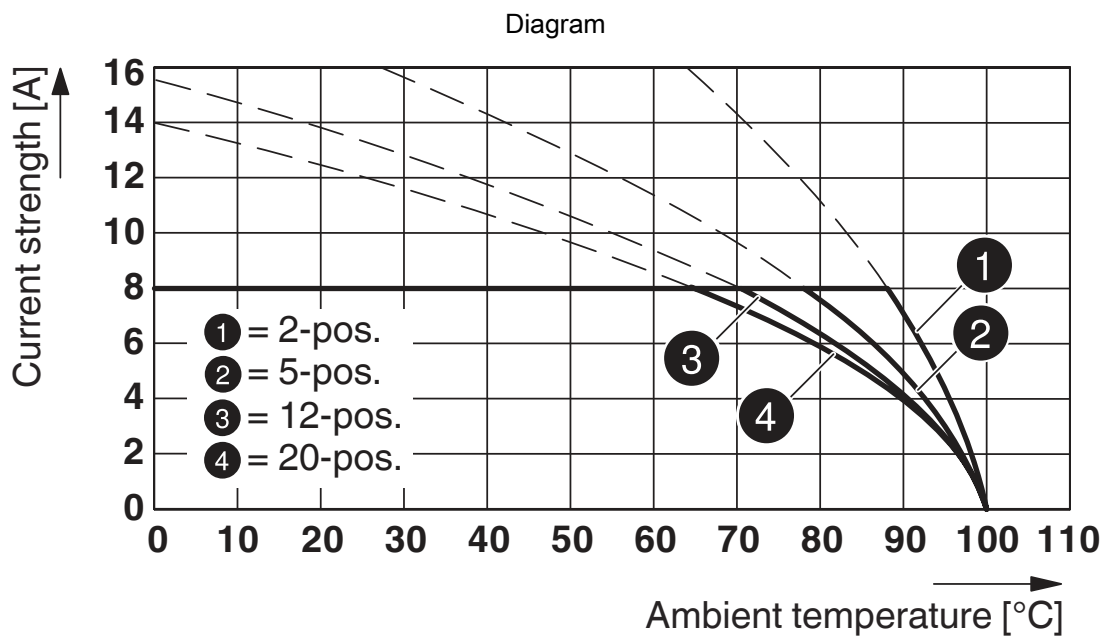

Type: FK-MCP 1,5/...-ST-3,5 with MC 1,5/...-G-3,5

MC 1,5/ 6-G-3,5 - PCB header

1844252

<https://www.phoenixcontact.com/us/products/1844252>

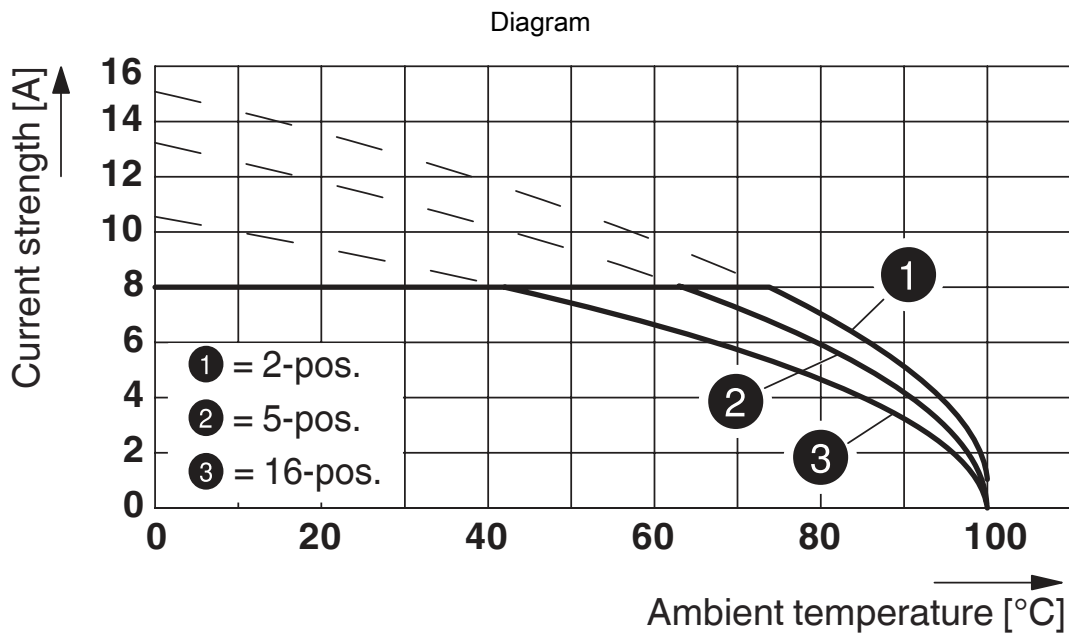

Type: MCVW 1,5/...-ST-3,5 with MC 1,5/...-G-3,5

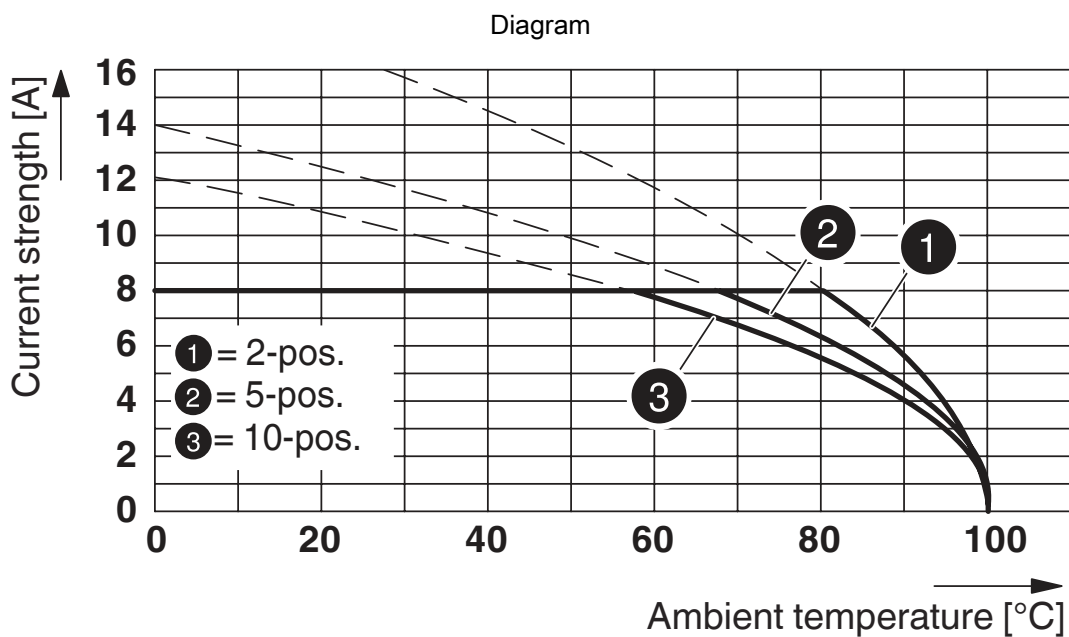

Type: TFMC 1,5/...-ST-3,5 with MC 1,5/...-G-3,5

MC 1,5/ 6-G-3,5 - PCB header

1844252

<https://www.phoenixcontact.com/us/products/1844252>



Dimensional drawing

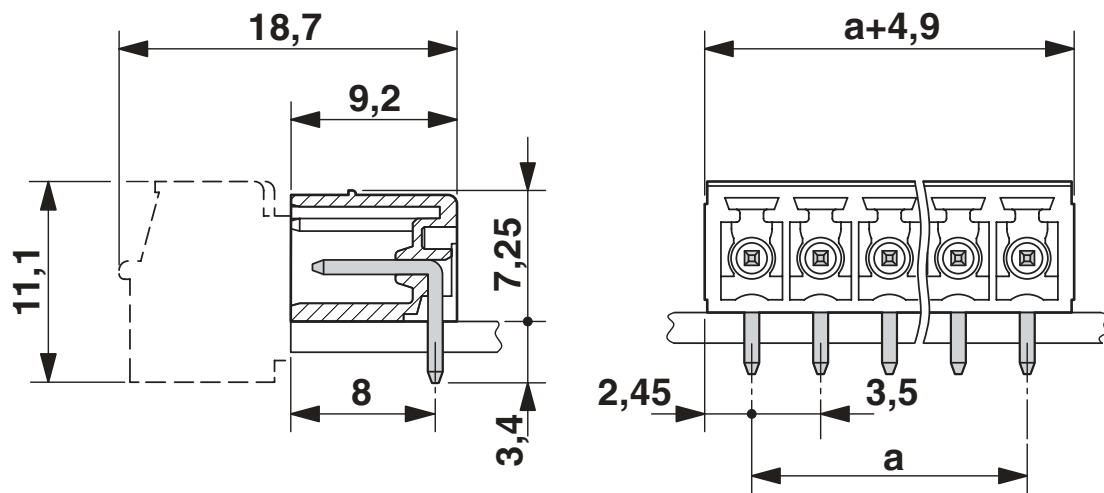

Drilling plan/solder pad geometry

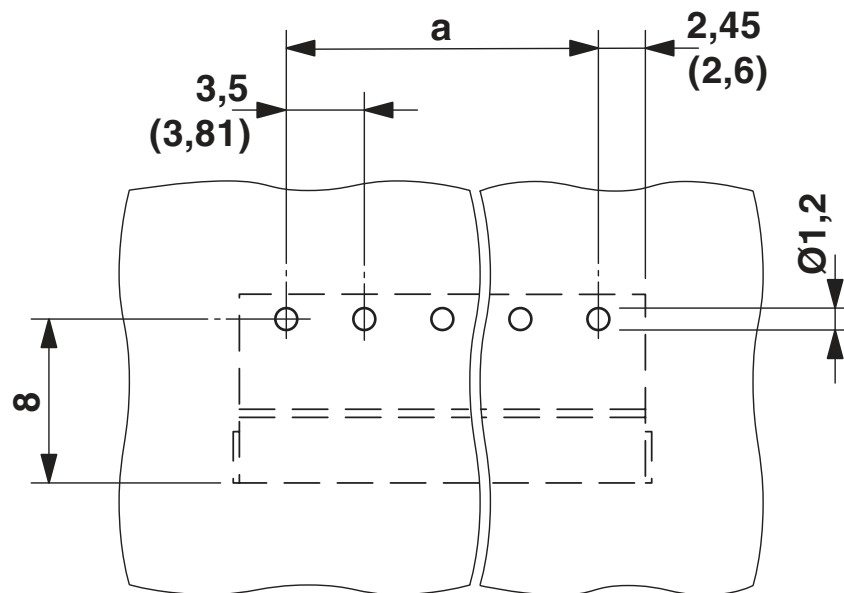

MC 1,5/ 6-G-3,5 - PCB header





1844252

<https://www.phoenixcontact.com/us/products/1844252>

Approvals

To download certificates, visit the product detail page: <https://www.phoenixcontact.com/us/products/1844252>

 CSA Approval ID: 13631				
	Nominal voltage U_N	Nominal current I_N	Cross section AWG	Cross section mm^2
Use group B	300 V	8 A	-	-
Use group D	300 V	8 A	-	-

 EAC Approval ID: B.01687				
--	--	--	--	--

 cULus Recognized Approval ID: E60425-20110128				
	Nominal voltage U_N	Nominal current I_N	Cross section AWG	Cross section mm^2
Use group B	300 V	8 A	-	-
Use group D	300 V	8 A	-	-

 VDE Zeichengenehmigung Approval ID: 40011723				
	Nominal voltage U_N	Nominal current I_N	Cross section AWG	Cross section mm^2
	160 V	8 A	-	-

MC 1,5/ 6-G-3,5 - PCB header



1844252

<https://www.phoenixcontact.com/us/products/1844252>

Classifications

ECLASS

ECLASS-11.0	27460201
ECLASS-12.0	27460201
ECLASS-13.0	27460201

ETIM

ETIM 8.0	EC002637
----------	----------

UNSPSC

UNSPSC 21.0	39121400
-------------	----------

MC 1,5/ 6-G-3,5 - PCB header

1844252

<https://www.phoenixcontact.com/us/products/1844252>



Environmental product compliance

China RoHS	Environmentally friendly use period: unlimited = EFUP-e
	No hazardous substances above threshold values

MC 1,5/ 6-G-3,5 - PCB header

1844252

<https://www.phoenixcontact.com/us/products/1844252>



Accessories

CP-MSTB - Coding profile

1734634

<https://www.phoenixcontact.com/us/products/1734634>

Coding profile, is inserted into the slot on the plug or inverted header, red insulating material



MC 1,5/10-LWL 1,5-3,5 - Fiber optic

1841161

<https://www.phoenixcontact.com/us/products/1841161>

MINI COMBICON fiber optics, 3.5 mm pitch, 10-pos., separable for other numbers of positions (minimum: 2-pos.), inserts into the back of the MC header, color: transparent, dimension a: 1.5 mm



MC 1,5/ 6-G-3,5 - PCB header

1844252

<https://www.phoenixcontact.com/us/products/1844252>



MC 1,5/10-LWL 2,3-3,5 - Fiber optic

1841187

<https://www.phoenixcontact.com/us/products/1841187>

MINI COMBICON fiber optics, 3.5 mm pitch, 10-pos., separable for other numbers of positions (minimum: 2-pos.), inserts into the back of the MC header, color: transparent, dimension a: 2.3 mm



MC 1,5/10-LWL 4-3,5 - Fiber optic

1841200

<https://www.phoenixcontact.com/us/products/1841200>

MINI COMBICON fiber optics, 3.5 mm pitch, 10-pos., separable for other numbers of positions (minimum: 2-pos.), inserts into the back of the MC header, color: transparent, dimension a: 4 mm



MC 1,5/ 6-G-3,5 - PCB header

1844252

<https://www.phoenixcontact.com/us/products/1844252>



SK 3,5/2,8:FORTL.ZAHLEN - Marker card

0804073

<https://www.phoenixcontact.com/us/products/0804073>



Marker card, white, labeled, horizontal: consecutive numbers 1 ... 10, 11 ... 20, etc. up to 91 ... 99, mounting type: adhesive, for terminal block width: 3.5 mm, lettering field size: 3.5 x 2.8 mm

TFMC 1,5/ 6-ST-3,5 - Printed-circuit board connector

1772650

<https://www.phoenixcontact.com/us/products/1772650>

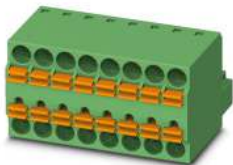

PCB connector, nominal cross section: 1.5 mm², color: green, nominal current: 8 A, rated voltage (III/2): 160 V, contact surface: Tin, contact connection type: Socket, number of potentials: 6, number of rows: 1, number of positions: 6, number of connections: 12, product range: TFMC 1,5/..-ST, pitch: 3.5 mm, connection method: Push-in spring connection, conductor/PCB connection direction: 0 °, plug-in system: COMBICON MC 1,5, locking: without, mounting: without, type of packaging: packed in cardboard

MC 1,5/ 6-G-3,5 - PCB header

1844252

<https://www.phoenixcontact.com/us/products/1844252>



MC 1,5/ 6-ST-3,5 - PCB connector

1840405

<https://www.phoenixcontact.com/us/products/1840405>



PCB connector, nominal cross section: 1.5 mm², color: green, nominal current: 8 A, rated voltage (III/2): 160 V, contact surface: Tin, contact connection type: Socket, number of potentials: 6, number of rows: 1, number of positions: 6, number of connections: 6, product range: MC 1,5/...-ST, pitch: 3.5 mm, connection method: Screw connection with tension sleeve, screw head form: L Slotted, conductor/PCB connection direction: 0 °, plug-in system: COMBICON MC 1,5, locking: without, mounting: without, type of packaging: packed in cardboard

MCVW 1,5/ 6-ST-3,5 - PCB connector

1862894

<https://www.phoenixcontact.com/us/products/1862894>



PCB connector, nominal cross section: 1.5 mm², color: green, nominal current: 8 A, rated voltage (III/2): 160 V, contact surface: Tin, contact connection type: Socket, number of potentials: 6, number of rows: 1, number of positions: 6, number of connections: 6, product range: MCVW 1,5/...-ST, pitch: 3.5 mm, connection method: Screw connection with tension sleeve, screw head form: L Slotted, conductor/PCB connection direction: -90 °, plug-in system: COMBICON MC 1,5, locking: without, mounting: without, type of packaging: packed in cardboard

MC 1,5/ 6-G-3,5 - PCB header

1844252

<https://www.phoenixcontact.com/us/products/1844252>



MCVR 1,5/ 6-ST-3,5 - PCB connector

1863194

<https://www.phoenixcontact.com/us/products/1863194>



PCB connector, nominal cross section: 1.5 mm², color: green, nominal current: 8 A, rated voltage (III/2): 160 V, contact surface: Tin, contact connection type: Socket, number of potentials: 6, number of rows: 1, number of positions: 6, number of connections: 6, product range: MCVR 1,5/...-ST, pitch: 3.5 mm, connection method: Screw connection with tension sleeve, screw head form: L Slotted, conductor/PCB connection direction: 90 °, plug-in system: COMBICON MC 1,5, locking: without, mounting: without, type of packaging: packed in cardboard

FK-MCP 1,5/ 6-ST-3,5 - PCB connector

1939950

<https://www.phoenixcontact.com/us/products/1939950>

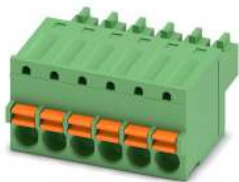

PCB connector, nominal cross section: 1.5 mm², color: green, nominal current: 8 A, rated voltage (III/2): 160 V, contact surface: Tin, contact connection type: Socket, number of potentials: 6, number of rows: 1, number of positions: 6, number of connections: 6, product range: FK-MCP 1,5/...-ST, pitch: 3.5 mm, connection method: Push-in spring connection, conductor/PCB connection direction: 0 °, plug-in system: COMBICON MC 1,5, locking: without, mounting: without, type of packaging: packed in cardboard

MC 1,5/ 6-G-3,5 - PCB header

1844252

<https://www.phoenixcontact.com/us/products/1844252>



FMC 1,5/ 6-ST-3,5 - Printed-circuit board connector

1952306

<https://www.phoenixcontact.com/us/products/1952306>



PCB connector, nominal cross section: 1.5 mm², color: green, nominal current: 8 A, rated voltage (III/2): 160 V, contact surface: Tin, contact connection type: Socket, number of potentials: 6, number of rows: 1, number of positions: 6, number of connections: 6, product range: FMC 1,5/..-ST, pitch: 3.5 mm, connection method: Push-in spring connection, conductor/PCB connection direction: 0 °, plug-in system: COMBICON MC 1,5, locking: without, mounting: without, type of packaging: packed in cardboard

XPC 1,5/ 6-ST-3,5 BK - PCB connector

1464109

<https://www.phoenixcontact.com/us/products/1464109>



PCB connector, nominal cross section: 1.5 mm², color: black, nominal current: 8 A, rated voltage (III/2): 160 V, contact surface: Tin, contact connection type: Socket, number of rows: 1, number of positions: 6, product range: XPC 1,5/..-ST, pitch: 3.5 mm, connection method: Push-X-connection, conductor/PCB connection direction: 0 °, locking clip: - without locking clip, plug-in system: COMBICON MC 1,5, locking: without, mounting: without, type of packaging: packed in cardboard

Phoenix Contact 2023 © - all rights reserved
<https://www.phoenixcontact.com>

Phoenix Contact USA
586 Fulling Mill Road
Middletown, PA 17057, United States
(+717) 944-1300
info@phoenixcon.com