

HEAVY DUTY GOOSENECK FLEX ARM

95011 24" Long, 3/8-16 Female, Magnetic Base

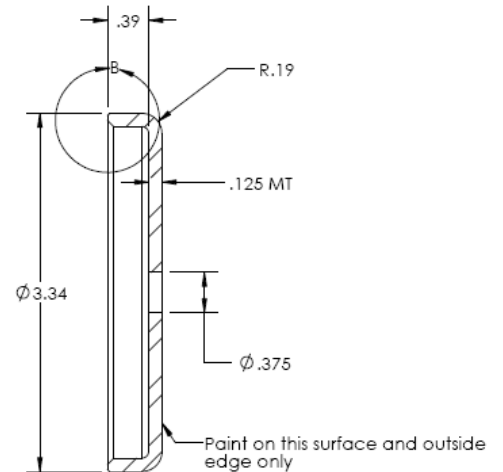

ARM LENGTH	24" (609.6mm)
ARM MATERIAL	Steel
OUTSIDE DIAMETER	.695"
INSIDE DIAMETER	.325"
LOAD RATING	Max Load @ 90 Degrees: <u>1.5 pounds</u>
FEEL	Heavy Duty, Feels Stiff
MOUNTING STYLE	Magnetic Base, 3.0" Dia (76.2mm)
TOP FITTING	3/8-16 UNC Female Thread
BASE FITTING	3/8-16 UNC Female Thread, with Magnetic Base Attached
COVERING SLEEVE	PVC, Matte Black

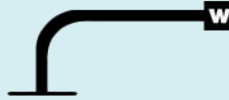

800-346-0761

222 Cessna Street
Watertown, SD 57201

sales@moffattproducts.com

