

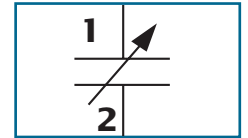

RELATIVE HUMIDITY SENSOR

HS 1100 / HS 1101

Based on a unique capacitive cell, these relative humidity sensors are designed for high volume, cost sensitive applications such as **office automation, automotive cabin air control, home appliances, and industrial process control systems**. They are also useful in all applications where humidity compensation is needed.



FEATURES

- **Full interchangeability** with no calibration required in standard conditions
- **Instantaneous desaturation** after long periods in saturation phase
- Compatible with automatized assembly processes, **including wave soldering, reflow and water immersion** (1)
- High reliability and long term stability
- Patented solid polymer structure
- Suitable for linear voltage or frequency output circuitry
- Fast response time
- Individual marking for compliance to stringent traceability requirements

(1) soldering temperature profiles available on request

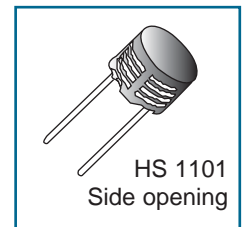

MAXIMUM RATINGS (Ta= 25°C unless otherwise noted)

Ratings	Symbol	Value	Unit
Operating Temperature	Ta	-40 to 100	°C
Storage Temperature	Tstg	-40 to 125	°C
Supply Voltage	Vs	10	Vac
Humidity Operating Range	RH	0 to 100	% RH
Soldering @ T = 260°C	t	10	s

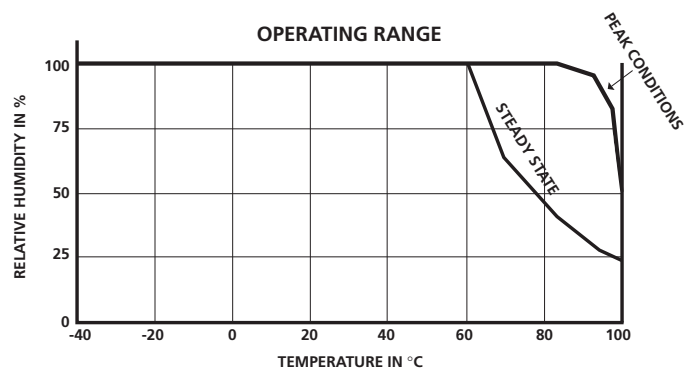

CHARACTERISTICS

(Ta = 25°C, measurement frequency @ 10kHz unless otherwise noted)

Characteristics	Symbol	Min.	Typ.	Max.	Unit.
Humidity measuring range	RH	1		99	%
Supply voltage	Vs		5	10	V
Nominal capacitance @ 55% RH*	C	177	180	183	pF
Temperature coefficient	Tcc		0.04		pF/°C
Averaged Sensitivity from 33% to 75% RH	$\Delta C/\%RH$		0.34		pF/%RH
Leakage current (Vcc = 5 Volts)	Ix		1		nA
Recovery time after 150 hours of condensation	tr		10		s
Humidity Hysteresis			+/-1.5		%
Long term stability			0.5		%RH/yr
Response time (33 to 76 % RH, still air @ 63%)	ta		5		s
Deviation to typical response curve (10% to 90% RH)			+/-2		% RH

* Tighter specification available on request

CHARACTERISTICS (CONT'D)

**Typical response curve
of HS 1100/HS 1101 in humidity**

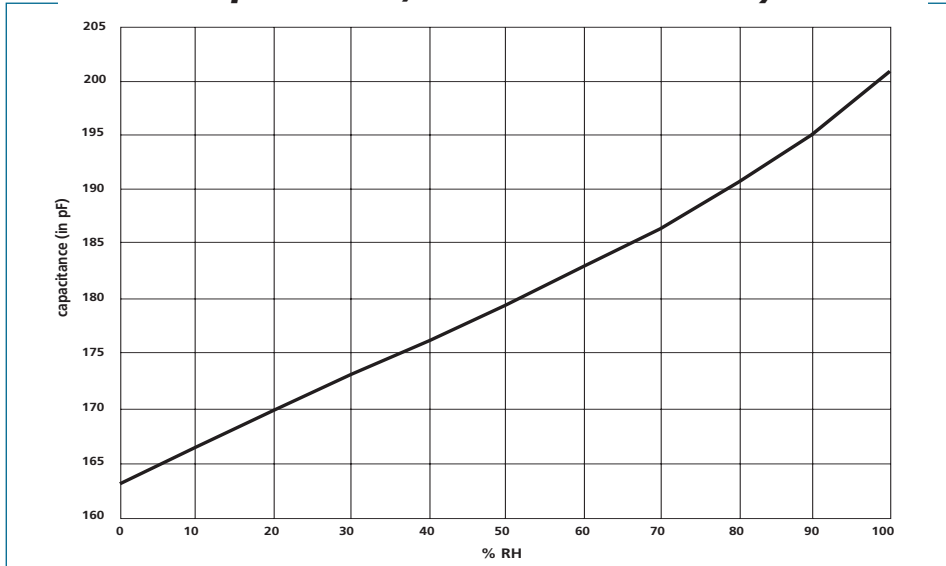

Calibration data are traceable to NIST standards through CETIAT laboratory.

Measurement frequency : 10kHz
Ta = 25°C

Polynomial response : $C(pf) = C@55\% * (1.2510^{-7} RH^3 - 1.3610^{-5} RH^2 + 2.1910^{-3} RH + 9.010^{-1})$
RH in % RH

Measurement frequency influence

In this data sheet, all capacitance measurements are @ 10kHz. However, the sensor can operate without restriction from 5kHz to 100kHz. To calculate the influence of frequency on capacitance measurements :

$$C@f\text{kHz} = C@10\text{kHz} (1.027 - 0.01185 \ln(f\text{kHz}))$$

Polarization

In order to get a better reproducibility during measurements, always connect the case of the header (pin 2) to the ground of the circuit.

The case of the header is located on the opposite side of the tab.

Soldering instructions : see the Application Note HPC007

PROPORTIONAL VOLTAGE OUTPUT CIRCUIT

Internal Block Diagram

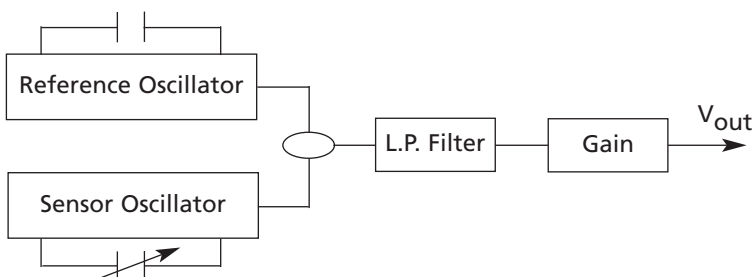

$$V_{out} = V_{cc} * (0.00474 * \%RH + 0.2354)$$

for 5 - 99% RH

Typical temperature coefficient :
+0.1% RH/°C - From 10 to 60°C

DEMO BOARD AVAILABLE ON REQUEST (REF HM1510)

Typical Characteristics for Voltage Output Circuit

At V_{CC} 5V - 25°C

RH	0	10	20	30	40	50	60	70	80	90	100
Voltage (V)	-	1.41	1.65	1.89	2.12	2.36	2.60	2.83	3.07	3.31	3.55

FREQUENCY OUTPUT CIRCUITS

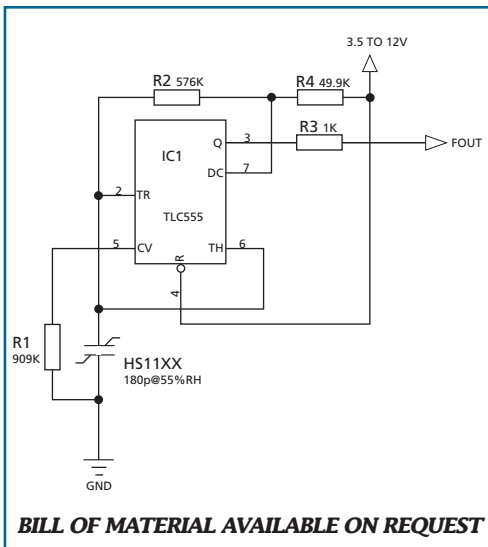

COMMENTS

This circuit is the typical astable design for 555. The HS1100/HS1101, used as variable capacitor, is connected to the TRIG and THRES pin. Pin 7 is used as a short circuit pin for resistor R4.

The HS1100/HS1101 equivalent capacitor is charged through R2 and R4 to the threshold voltage (approximately $0.67V_{CC}$) and discharged through R2 only to the trigger level (approximately $0.33V_{CC}$) since R4 is shorted to ground by pin 7.

Since the charge and discharge of the sensor run through different resistors, R2 and R4, the duty cycle is determined by :

$$t_{high} = C @ \%RH * (R2 + R4) * \ln 2$$

$$t_{low} = C @ \%RH * R2 * \ln 2$$

$$F = 1 / (t_{high} + t_{low}) = 1 / (C @ \%RH * (R4 + 2 * R2) * \ln 2)$$

$$\text{Output duty cycle} = t_{high} * F = R2 / (R4 + 2 * R2)$$

To provide an output duty cycle close to 50%, R4 should be very low compared to R2 but never under a minimum value.

Resistor R3 is a short circuit protection. 555 must be a CMOS version.

REMARK

R1 unbalances the internal temperature compensation scheme of the 555 in order to introduce a temperature coefficient that matches the HS1100/HS1101 temperature coefficient. In all cases, R1 should be a 1% resistor with a maximum of 100ppm coefficient temperature like all other R-C timer resistors. Since 555 internal temperature compensation changes from one trademark to one other, R1 value should be adapted to the specific chip. To keep the nominal frequency of 6660Hz at 55%RH, R2 also needs slight adjustment as shown in the table.

555 Type	R1	R2
TLC555 (Texas)	909k Ω	576k Ω
TS555 (STM)	100nF capacitor	523k Ω
7555 (Harris)	1732k Ω	549k Ω
LMC555 (National)	1238k Ω	562k Ω

For a frequency of 6660Hz at 55%RH

Typical Characteristics for Frequency Output Circuits

REFERENCE POINT AT 6660Hz FOR 55%RH / 25°C

RH	0	10	20	30	40	50	60	70	80	90	100
Frequency	7351	7224	7100	6976	6853	6728	6600	6468	6330	6186	6033

Typical for a 555 Cmos type. TLC555 (RH : Relative Humidity in %, F : Frequency in Hz)

Polynomial response :

$$F_{mes}(Hz) = F_{55}(Hz) * (1.1038 - 1.936810^{-3} * RH + 3.011410^{-6} * RH^2 - 3.440310^{-8} * RH^3)$$

Measurement Error vs Stray Capacitance

A special attention is required in order to minimize stray capacitance in the layout. The added capacitance will act as a parallel capacitance with the sensor and create a measurement error.

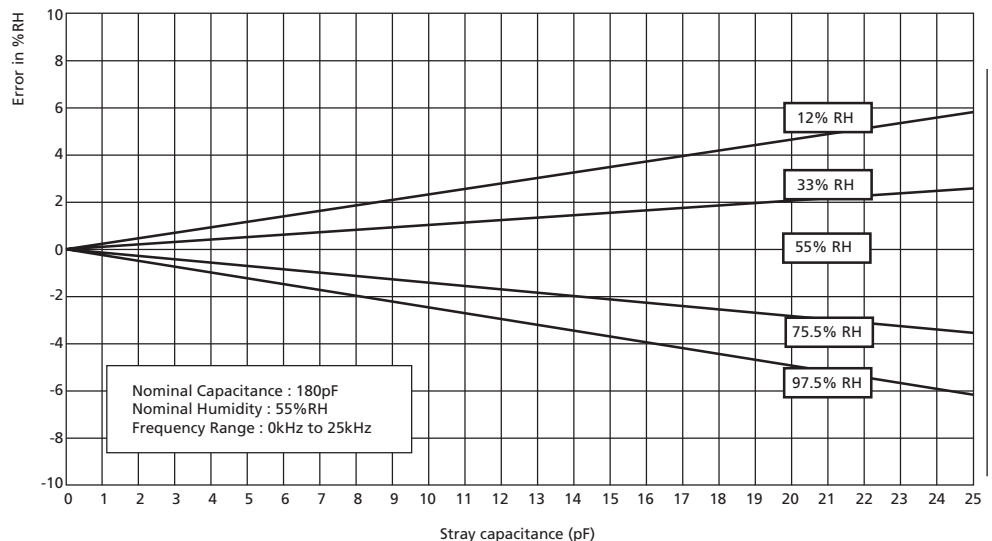

● QUALIFICATION PROCESS

- HS1100/HS1101 sensors have been qualified through a complete qualification process taking in account many of the requirements of the MIL STD750 including :

Solder heat and solderability
 Wave soldering at 260°C + DI water clean at 45°C
 Mechanical shock - 1500 g, 5 blows, 3 directions
 Vibration - Variable (F = 100 - 2000Hz), fixed (F = 35Hz)
 Constant acceleration
 Marking permanency
 ESD - Electrostatic Discharge - Human body & Machine model
 Salt Atmosphere MIL STD750/Method 1041/96 hours
 Temperature Cycling - 40°C / +85°C

High Temperature / Humidity Operating Life - 93%RH / 60°C for 1000 hours
 Low humidity storage life - RH < 10%/23°C - 1000 hours
 Resistance to immersion in water at ambient temperature and 80°C - 160 hours
 Resistance to acid vapors at 75000 ppm for nitric, sulfuric and chlorhydric acids
 Resistance to many chemicals linked with home appliances/ automotive or consumer applications.

All these tests are regularly performed on different lots from production. **More information are available on request**

● Environmental and recycling information :

- HS1100/HS1101 sensors are lead free components
 - HS1100/HS1101 sensors are free of Cr (VI), Cd and Hg.

**PACKAGE
 OUTLINE
 HS1100**

Dim	Min (mm)	Max (mm)
A	9.00	9.30
B	8.00	8.50
C	3.50	3.90
D	12.00	14.00
E	0.40	0.50
G	45° BCS	
H	0.70	1.10
J	0.70	0.90
K	4.83	5.33

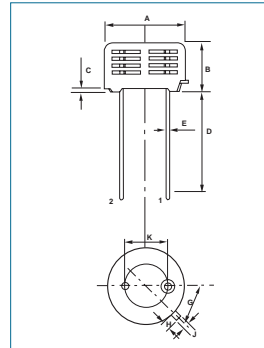
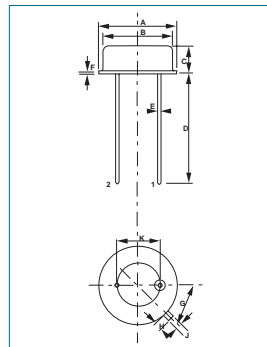

Dim	Min (mm)	Max (mm)
A	9.70	10.20
B	5.70	6.20
C	0.40	0.60
D	12.00	14.00
E	0.40	0.50
G	45° BCS	
H	0.70	1.10
J	0.70	0.90
K	4.83	5.33

**PACKAGE
 OUTLINE
 HS1101**
ORDERING INFORMATION :

HS 1100 : HPP 800 A 001 (MULTIPLE PACKAGE QUANTITY OF 50 PIECES)

HS 1101 : HPP 801 A 001 (MULTIPLE PACKAGE QUANTITY OF 48 PIECES)

CAPACITIVE RELATIVE HUMIDITY SENSOR.

**SAMPLE KIT OF HS1100-HS1101
 IS AVAILABLE THROUGH
 HUMIREL WEB SITE**

www.humirel.com

email : sales@humirel.com

The information in this sheet has been carefully reviewed and is believed to be accurate; however, no responsibility is assumed for inaccuracies. Furthermore, this information does not convey to the purchaser of such devices any license under the patent rights to the manufacturer. Humirel reserves the right to make changes without further notice to any product herein. Humirel makes no warranty, representation or guarantee regarding the suitability of its product for any particular purpose, nor does Humirel assume any liability arising out of the application or use of any product or circuit and specifically disclaims any and all liability, including without limitation consequential or incidental damages. « Typical » parameters can and do vary in different applications. All operating parameters, including « Typical » must be validated for each customer applications by customer's technical experts. Humirel does not convey any license under its patent rights nor the rights of others. Humirel products are not designed, intended, or authorized for use as components in systems intended for surgical implant into the body, or other application intended to support or sustain life, or for any application in which the failure of the Humirel product could create a situation where personal injury or death may occur. Should buyer purchase or use Humirel products for any such unintended or unauthorized application, Buyer shall indemnify and hold Humirel and its officers, employees, subsidiaries, affiliates and distributors harmless against all claims, costs, damages and expenses, and reasonable attorney fees arising out of, directly or indirectly, any claim of personal injury or death associated with such unintended or unauthorized use, even if such claim alleges that Humirel was negligent regarding the design or manufacture of the part. Humirel is a registered trade mark of Humirel.