

SC BASE/SC MODULE

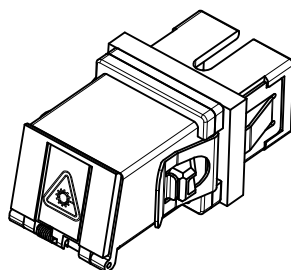

SC BASE/FC MODULE

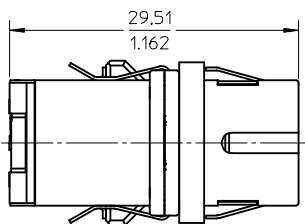
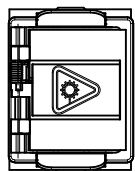
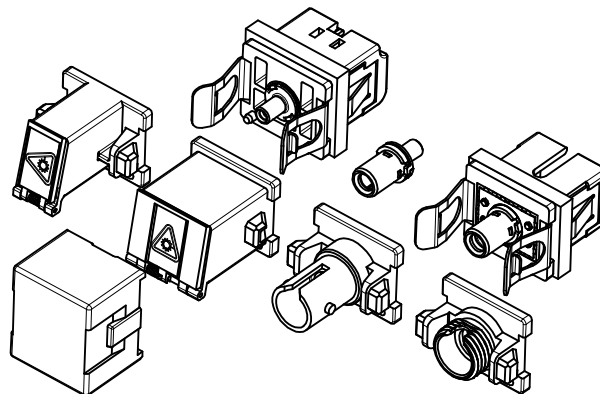
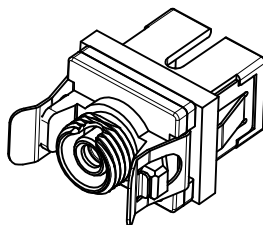
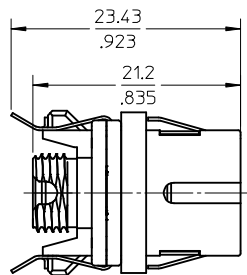
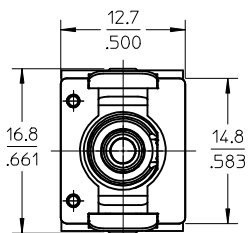

SC BASE/ST MODULE

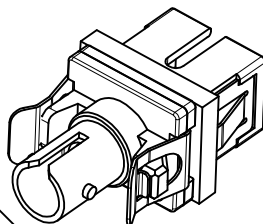
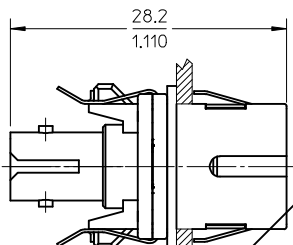
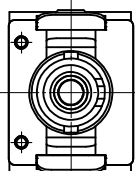

SC BASE/LC MODULE

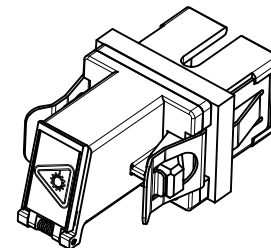
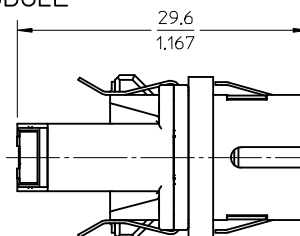
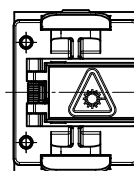

WORK-AREA PLOT

NOTES:
ALL DIMENSIONS ARE FOR REFERENCE ONLY.

ENTER DESCRIPTION EC NO: MF2007-0670 DRAWN: SERNST 2007/05/07 CHKD: 2007/05/07 APPR: SMIGO 2007/05/11 B	QUALITY SYMBOLS ▽=0 ▽=0	GENERAL TOLERANCES (UNLESS SPECIFIED)		DIMENSION STYLE MM/IN	SCALE 2:1	DESIGN UNITS METRIC	THIRD ANGLE PROJECTION		
		4 PLACES ± --- ± --- 3 PLACES ± --- ± --- 2 PLACES ± --- ± --- 1 PLACE ± --- ± ---	mm INCH	DRAWN BY DATE SERNST 2006/02/13	CHECKED BY DATE DSZILAGYI 2006/03/07	DEVELOPMENT KIT UNIVERSAL ADAPTER			
		ANGULAR ± 1 °		APPROVED BY DATE SMIGO 2006/03/07	MOLEX INCORPORATED				
		DRAFT WHERE APPLICABLE MUST REMAIN WITHIN DIMENSIONS		MATERIAL NO. 1061540000	DOCUMENT NO. SD-106154-0000	SHEET NO. 1 OF 2			

LC BASE/LC MODULE

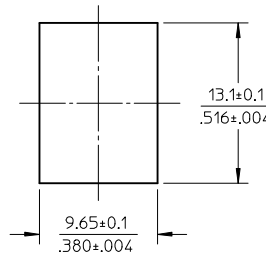
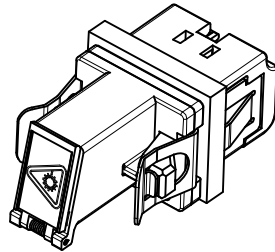
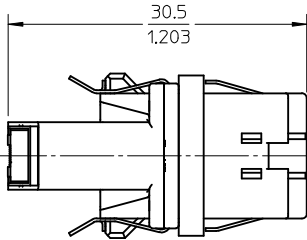
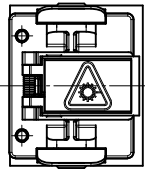

RECOMMENDED MOUNTING CUTOUT FOR SC BASE (SEE NOTE)
(1.6mm THICK PANEL)

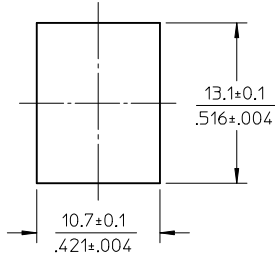

RECOMMENDED MOUNTING CUTOUT FOR LC BASE (SEE NOTE)
(1.6mm THICK PANEL)

LC BASE/SC MODULE

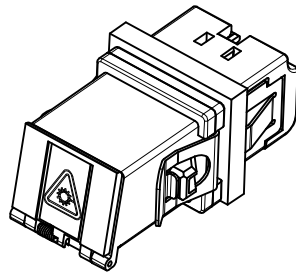
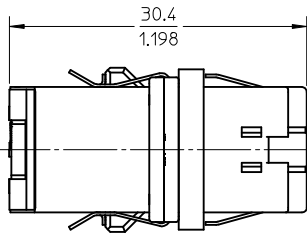
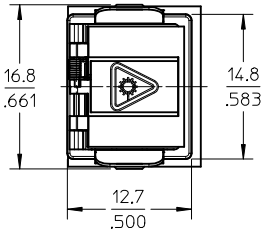

LC BASE/ST MODULE

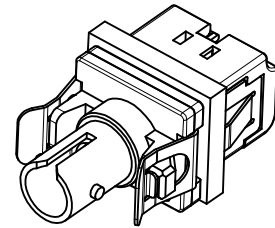
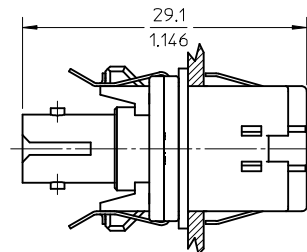
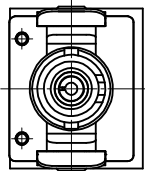

1.6
.063 PANEL

LC BASE/FC MODULE

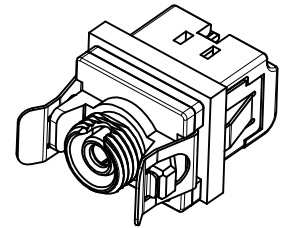
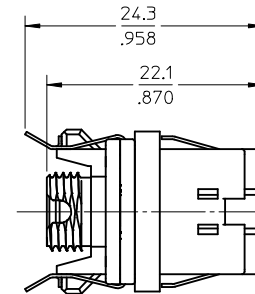
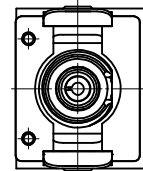

NOTE:

LC BASE CUTOUT MAY ALSO BE USED FOR THE SC BASE. DESPITE THE ADDITIONAL MOVEMENT, THE EMI GASKET WILL STILL FUNCTION AND EMI PROTECTION WILL NOT BE COMPROMISED.

ENTER DESCRIPTION EC NO: MF2007-0670 DRWN:SERNST 2007/05/07 CHKD: 2007/05/07 APPR:SMIGO 2007/05/11 B	QUALITY SYMBOLS ▽=0 ▽=0	GENERAL TOLERANCES (UNLESS SPECIFIED) mm INCH 4 PLACES ± --- ± --- 3 PLACES ± --- ± --- 2 PLACES ± --- ± --- 1 PLACE ± --- ± --- ANGULAR ± 1°	DIMENSION STYLE MM/IN DRAWN BY DATE SERNST 2006/02/13 CHECKED BY DATE DSZILAGYI 2006/03/07 APPROVED BY DATE SMIGO 2006/03/07	SCALE 2:1 DESIGN UNITS METRIC THIRD ANGLE PROJECTION	DEVELOPMENT KIT UNIVERSAL ADAPTER
	DRAFT WHERE APPLICABLE MUST REMAIN WITHIN DIMENSIONS		MATERIAL NO. 1061540000 SIZE B	DOCUMENT NO. SD-106154-0000	SHEET NO. 2 OF 2
	THIS DRAWING CONTAINS INFORMATION THAT IS PROPRIETARY TO MOLEX INCORPORATED AND SHOULD NOT BE USED WITHOUT WRITTEN PERMISSION				
	MOLEX INCORPORATED				