



MIC33263/4

4MHz, 2A Buck Regulator with Integrated Inductor and HyperLight Load[®]

General Description

The MIC33263/4 is a highly-efficient synchronous buck regulator with an integrated inductor which provides the optimal trade-off between footprint and efficiency. The MIC33263/4 operates at 4MHz switching frequency and provides up to 2A output current. In addition, the 100% duty cycle and HyperLight Load[®] (HLL) mode-of-operation delivers very-high efficiency at light loads and ultra-fast transient response which makes the MIC33263/4 perfectly suited for any space-constrained application and great alternative for low dropout regulators. An additional benefit of this proprietary architecture is very low output voltage throughout the entire load range with the use of small output capacitors.

The MIC33263/4 provides small compact total solution size of 4.6mm × 7mm with very few tiny external components.

At higher loads, the MIC33263/4 provides a constant switching frequency around 4MHz while achieving peak efficiencies up to 93%. It also includes under-voltage lockout to ensure proper operation under power-sag conditions, internal soft-start to reduce inrush current, foldback current limit, power good (PG) indicator, and thermal shutdown. The MIC33263/4 is available in a 20-pin 2.5mm × 3.0mm × 1.9mm QFN package with an operating junction temperature range from -40°C to +125°C.

Datasheets and support documentation are available on Micrel's website at: www.micrel.com.

Features

- Integrated MOSFETs, inductor
- **100% duty cycle**
- 4MHz PWM operation in continuous mode
- 2A output current
- Low output voltage ripple
- 85% typical efficiency at 1mA and up to 93% peak efficiency
- Ultra-fast transient response
- Advanced copper lead frame design provides superior thermal performance
- Thermal-shutdown and current-limit protection
- Low-radiated emission (EMI) per EN55022, class B
- Adjustable output voltage 0.7V to 5V
- Configurable soft-start with pre-bias start-up capability
- Auto discharge of 180Ω (MIC33264 only)
- Low profile 2.5mm × 3.0mm × 1.9mm QFN packages
- 0.1μA shutdown current
- 33μA quiescent current

Applications

- 5V point-of-load (POL)
- Low voltage distributed power systems
- Space-constrained applications
- Portable devices
- SSD storage systems
- Digital cameras

Typical Application

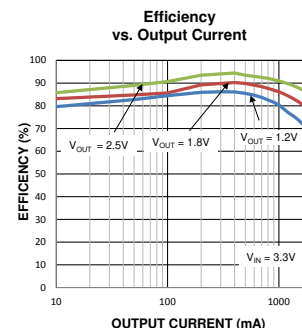
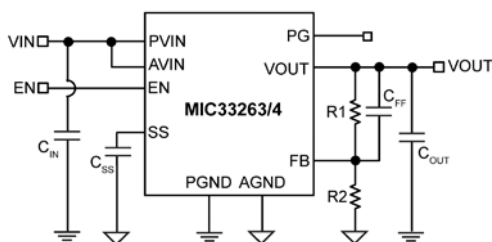

HyperLight Load is a registered trademark of Micrel, Inc.

Micrel Inc. • 2180 Fortune Drive • San Jose, CA 95131 • USA • tel +1 (408) 944-0800 • fax + 1 (408) 474-1000 • <http://www.micrel.com>

Ordering Information

Part Number	Output Voltage	Auto Discharge	Junction Temperature Range	Package ^(1, 2)
MIC33263YGK	ADJ	No	-40°C to +125°C	20-Pin 2.5mm × 3mm QFN
MIC33264YGK	ADJ	Yes	-40°C to +125°C	20-Pin 2.5mm × 3mm QFN

Note:

1. QFN is a GREEN, RoHS-compliant package. Mold compound is Halogen Free.
2. Pb-free. Lead finish is matte tin.

Pin Configuration

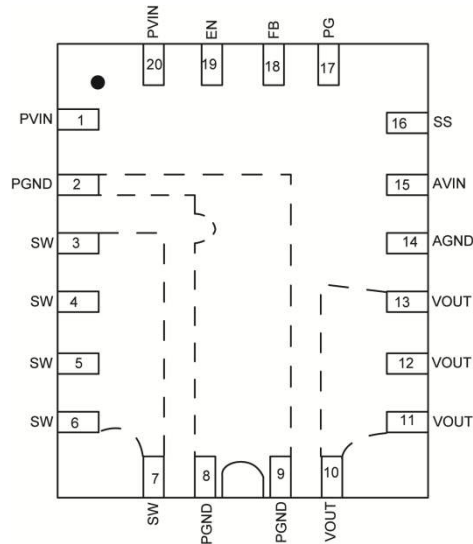

2.5mm × 3mm QFN (GK)
(Top View)

Pin Description

Pin Number	Pin Name	Pin Function
1, 20	PVIN	Power Input Voltage: Connect a capacitor to PGND to decouple the noise.
2, 8, 9	PGND	Power Ground.
3, 4, 5, 6, 7	SW	Switch (Output): Internal power MOSFET output switches. Disable pull down 180 Ohms (MIC33264 only).
10, 11, 12, 13	VOUT	Inductor Output. Connect a capacitor to PGND to filter the switcher output voltage.
14	AGND	Analog Ground: Connect to central ground point where all high current paths meet (CIN, COUT, PGND) for best operation.
15	AVIN	Analog Input Voltage: Connect a capacitor to ground to decouple the noise.
16	SS	Soft-Start: Place a capacitor from SS pin to ground to program the soft-start time
17	PG	Power Good: Open Drain output for the power good indicator. Place a resistor between this pin and a voltage source to detect a power good condition.
18	FB	Feedback: Connect a resistor divider from the output to ground to set the output voltage.
19	EN	Enable (Input): Logic high enables operation of the regulator. Logic low will shut down the device. Do not leave floating.

Absolute Maximum Ratings⁽³⁾

Supply Voltage ($V_{IN} = V_{AVIN} = V_{PVIN}$)	-0.3V to 6V
Power Good Voltage (V_{PG})	-0.3V to 6V
Output Switch Voltage (V_{SW})	-0.3V to 6V
Enable Input Voltage (V_{EN})	-0.3V to V_{IN}
Junction Temperature (T_J)	+150°C
Storage Temperature Range (T_S)	-65°C to +150°C
Lead Temperature (soldering, 10s)	260°C
ESD Rating ⁽⁵⁾	ESD Sensitive

Operating Ratings⁽⁴⁾

Supply Voltage ($V_{IN} = V_{AVIN} = V_{PVIN}$)	2.7V to 5.5V
Enable Input Voltage (V_{EN})	0V to V_{IN}
Feedback Voltage (V_{FB})	0.7V to V_{IN}
Junction Temperature Range (T_J)	-40°C ≤ T_J ≤ +125°C
Thermal Resistance	
20-Pin 2.5mm × 3mm QFN (θ_{JA})	50°C/W

Electrical Characteristics⁽⁶⁾

$T_A = 25^\circ\text{C}$; $V_{IN} = V_{EN} = 3.6\text{V}$; $C_{OUT} = 22\mu\text{F}$ unless otherwise specified. **Bold** values indicate $-40^\circ\text{C} \leq T_J \leq +125^\circ\text{C}$, unless otherwise specified.

Parameter	Condition	Min.	Typ.	Max.	Units
Supply Voltage Range		2.7		5.5	V
Undervoltage Lockout Threshold	Turn-On	2.40	2.53	2.65	V
Undervoltage Lockout Hysteresis			75		mV
Quiescent Current	$I_{OUT} = 0\text{mA}$, $V_{SNS} > 1.2 \times V_{OUT}$ Nominal		33	85	μA
Shutdown Current	$V_{EN} = 0\text{V}$; $V_{IN} = 5.5\text{V}$		0.1	2	μA
Output Voltage Accuracy	$V_{IN} = 3.6\text{V}$ if $V_{OUTNOM} < 2.5\text{V}$, $I_{LOAD} = 20\text{mA}$	-2.5		+2.5	%
	$V_{IN} = 5.5\text{V}$ if $V_{OUTNOM} \geq 2.5\text{V}$, $I_{LOAD} = 20\text{mA}$				
Feedback Regulation Voltage		0.682	0.7	0.717	V
Current Limit	$V_{SNS} = 0.9 \times V_{OUTNOM}$	2.5	3.3		A
Output Voltage Line Regulation	$V_{IN} = 3.6\text{V}$ to 5.5V , $I_{LOAD} = 20\text{mA}$		0.3		%/V
Output Voltage Load Regulation	$20\text{mA} \leq I_{LOAD} \leq 1\text{A}$, $V_{IN} = 3.6\text{V}$		0.3		%
	$20\text{mA} \leq I_{LOAD} \leq 1\text{A}$, $V_{IN} = 5.5\text{V}$				
PWM Switch On-Resistance	$I_{SW} = 100\text{mA}$ PMOS		0.13		Ω
	$I_{SW} = -100\text{mA}$ NMOS				
Switching Frequency	$I_{OUT} = 120\text{mA}$		4		MHz
Soft-Start (SS) Time	$V_{OUT} = 90\%$, $C_{SS} = 1\text{nF}$		1000		μs
Soft-Start (SS) Current	$V_{SS} = 0\text{V}$		2.2		μA
Power Good (PG) Threshold (Rising)	% of V_{NOM}	85	90	95	%

Notes:

- Exceeding the absolute maximum ratings may damage the device.
- The device is not guaranteed to function outside its operating ratings.
- Devices are ESD sensitive. Handling precautions are recommended. Human body model, 1.5k Ω in series with 100pF.
- Specification for packaged product only

Electrical Characteristics⁽⁶⁾ (Continued)

$T_A = 25^\circ\text{C}$; $V_{IN} = V_{EN} = 3.6\text{V}$; $C_{OUT} = 22\mu\text{F}$ unless otherwise specified. **Bold** values indicate $-40^\circ\text{C} \leq T_J \leq +125^\circ\text{C}$, unless otherwise specified.

Parameter	Condition	Min.	Typ.	Max.	Units
Power Good Threshold Hysteresis			7		%
Power Good Pull-Down	$V_{SNS} = 90\% V_{NOMINAL}$, $I_{PG} = 1\text{mA}$		60	200	mV
Enable Threshold	Turn-On	0.5	0.8	1.2	V
Enable Hysteresis			70		mV
Enable Input Current			0.1	2	μA
Overtemperature Shutdown			160		$^\circ\text{C}$
Overtemperature Shutdown Hysteresis			20		$^\circ\text{C}$
SW Pull-Down Resistance (MIC33264 only)	$V_{EN} = 0\text{V}$		180		Ω

Typical Characteristics

Efficiency vs. Output Current

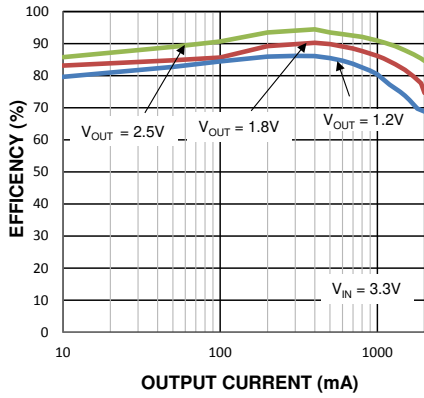

Efficiency vs. Output Current

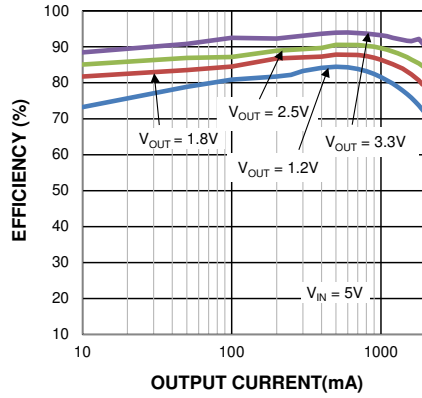

VOUT Rise Time vs. CSS

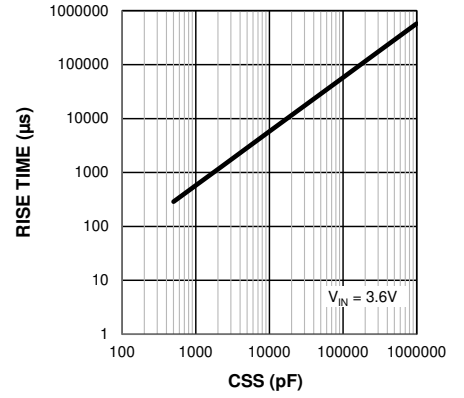

Current Limit vs. Input Voltage

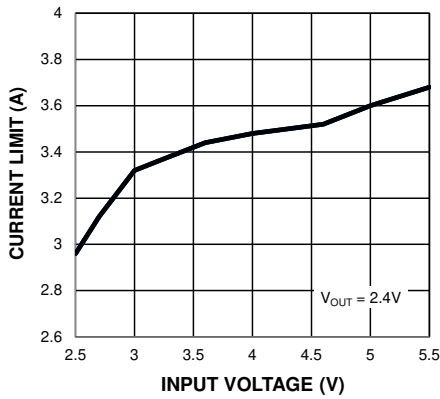

Quiscent Current vs. Input Voltage

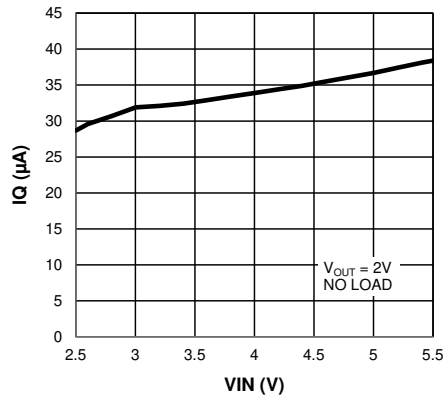

Quiscent Current vs. Temperature

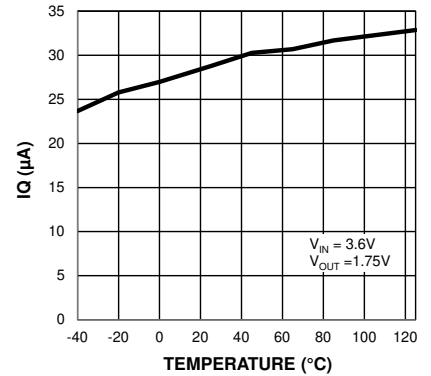

Line Regulation (Light Loads)

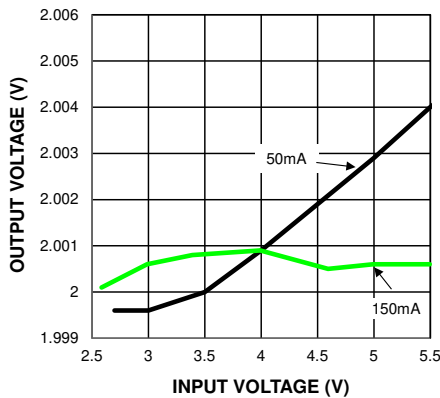

Line Regulation (High Loads)

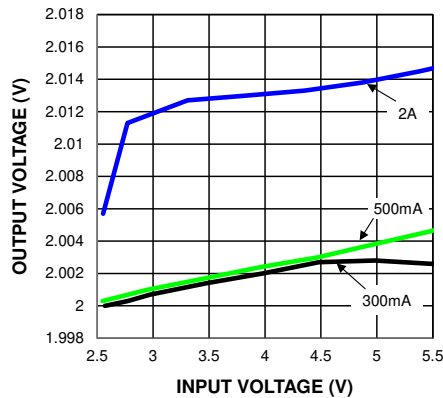

Output Voltage vs. Output Current (DCM)

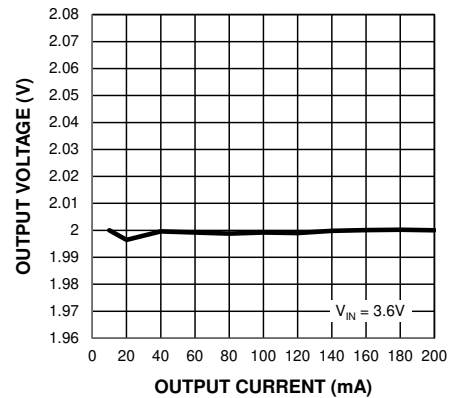

Typical Characteristics (Continued)

Output Voltage vs. Output Current (CCM)

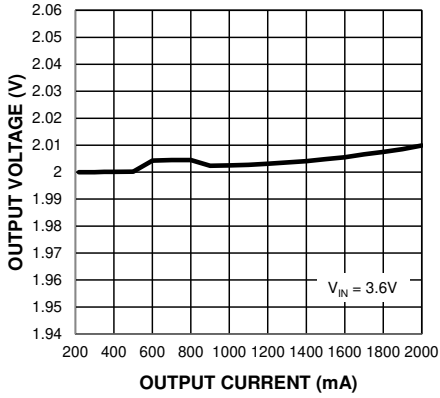

Output Voltage vs. Temperature

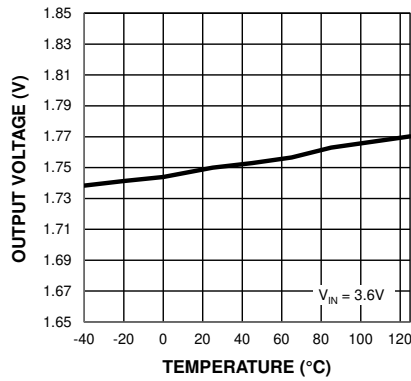

PG Threshold vs. Input Voltage

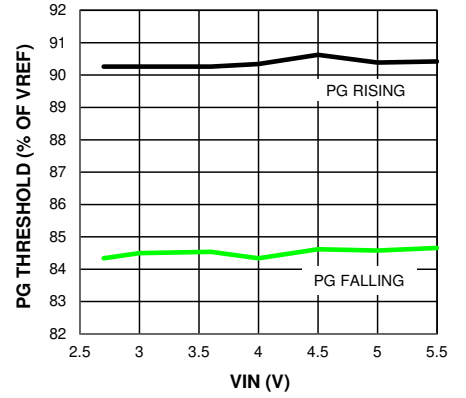

UVLO Threshold vs. Temperature

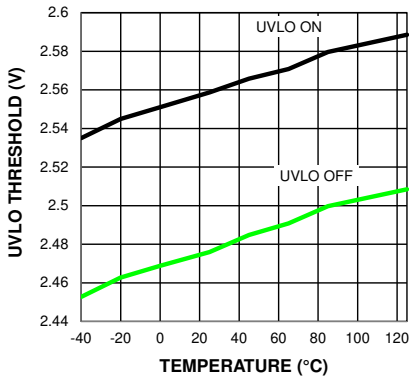

Enable Threshold vs. Temperature

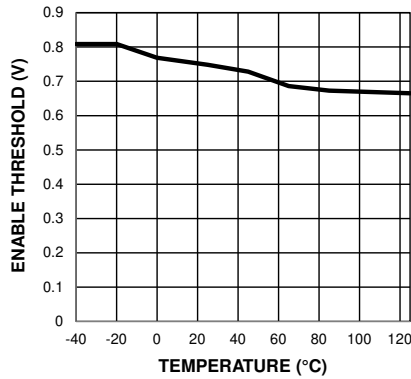

Enable Thresholds vs. Input Voltage

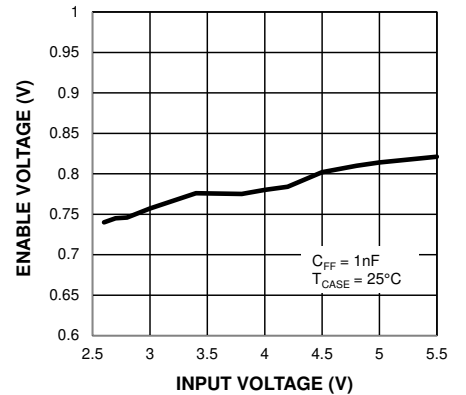

Switching Frequency vs. Output Current

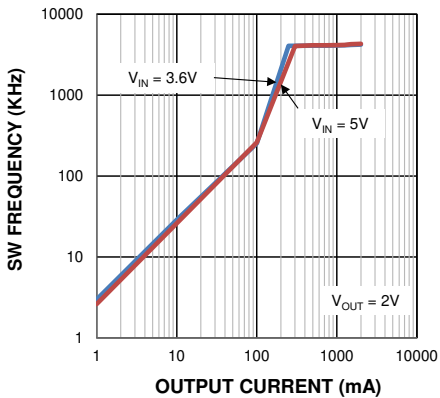

Feedback Voltage vs. Temperature

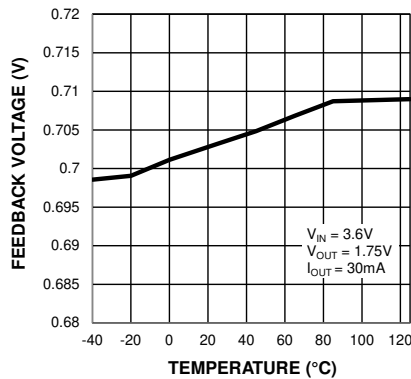

Shutdown Current vs. Temperature

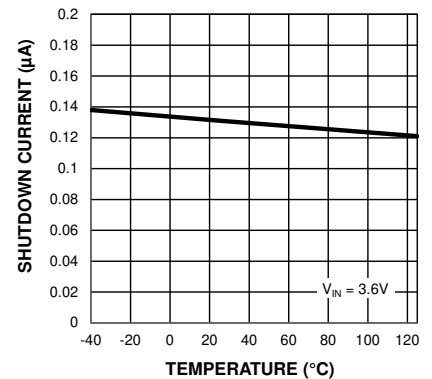

Functional Characteristics

**Switching Waveform
Discontinuous Mode (10mA)**

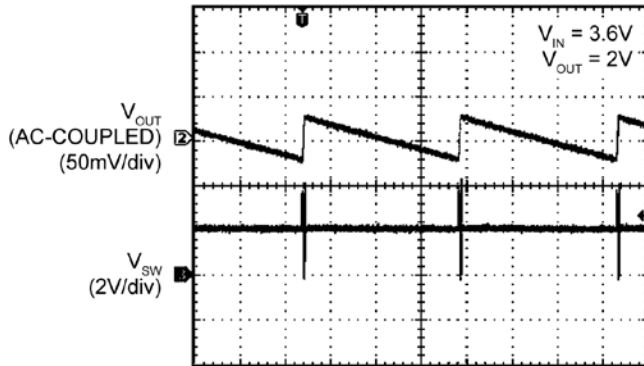

Time (10 μ s/div)

**Switching Waveform
Discontinuous Mode (50mA)**

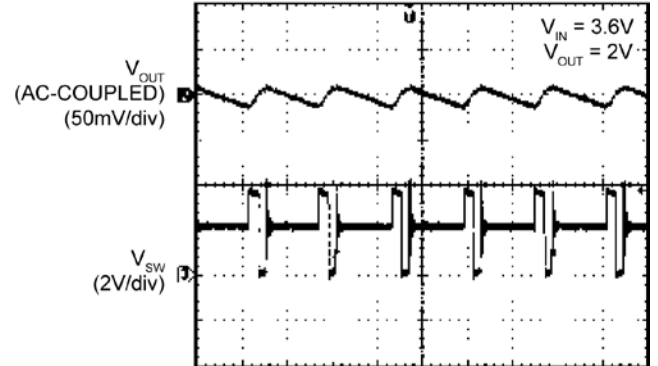

Time (1 μ s/div)

**Switching Waveform
Continuous Mode (200mA)**

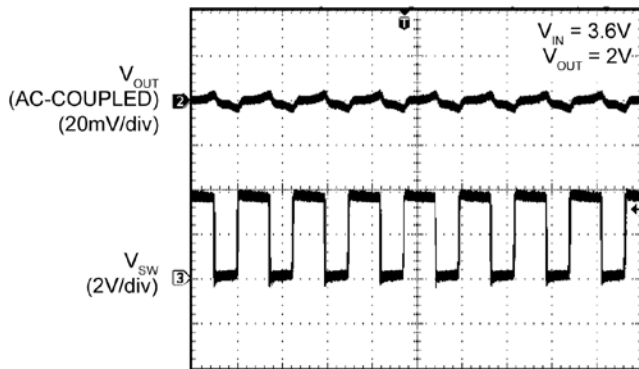

Time (200ns/div)

**Switching Waveform
Continuous Mode (800mA)**

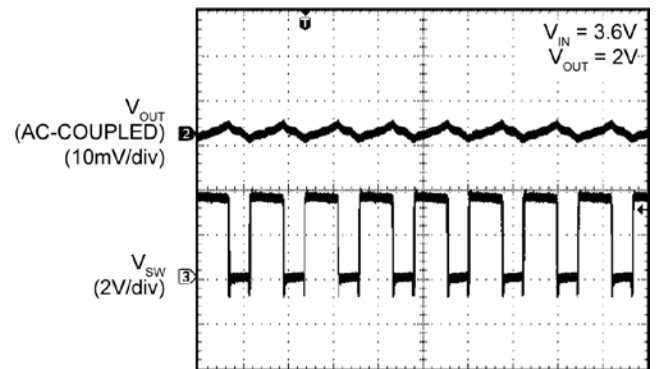

Time (200ns/div)

**Switching Waveform
Continuous Mode (1.5A)**

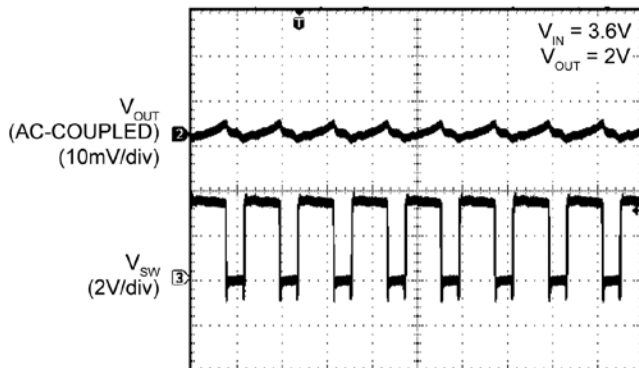

Time (200ns/div)

**Switching Waveform
Continuous Mode (2A)**

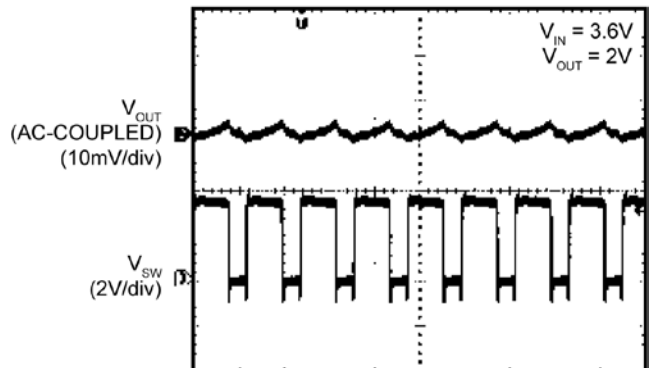

Time (40 μ s/div)

Functional Characteristics (Continued)

Load Transient (50mA – 400mA)

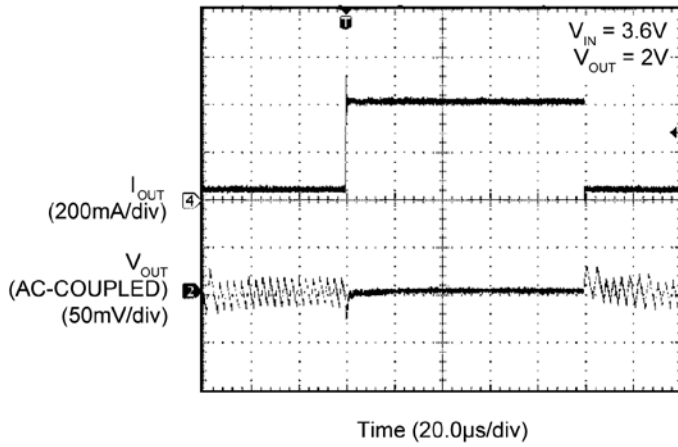

Load Transient (200mA – 600mA)

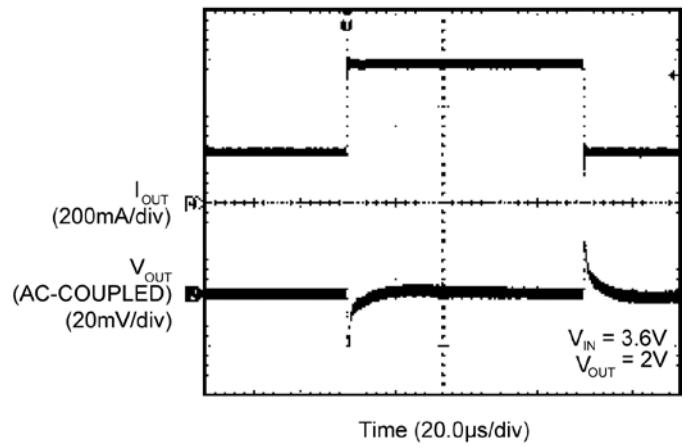

Load Transient (250mA – 1.5A)

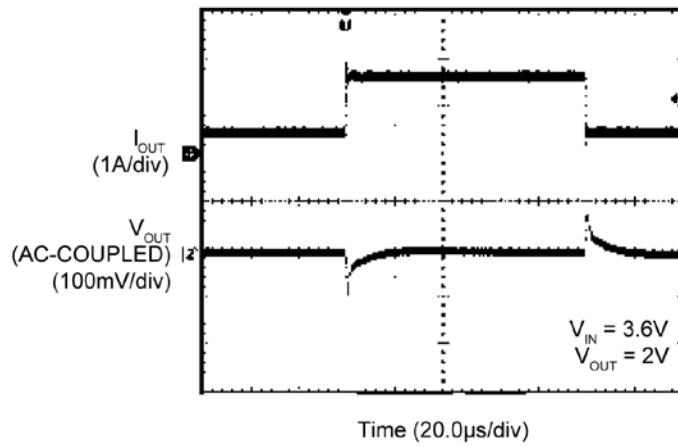

Load Transient (250mA – 2A)

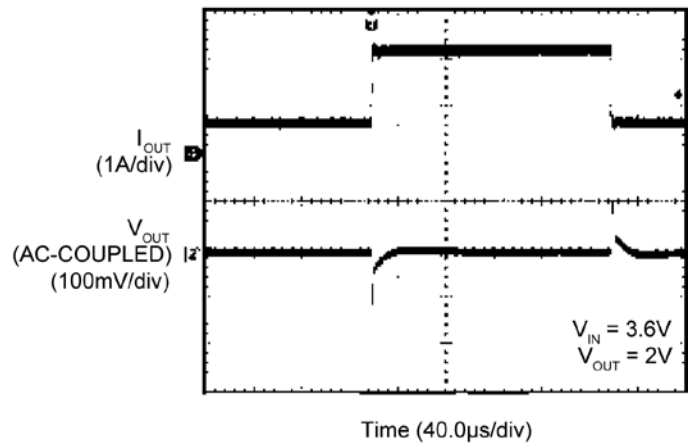

Functional Characteristics (Continued)

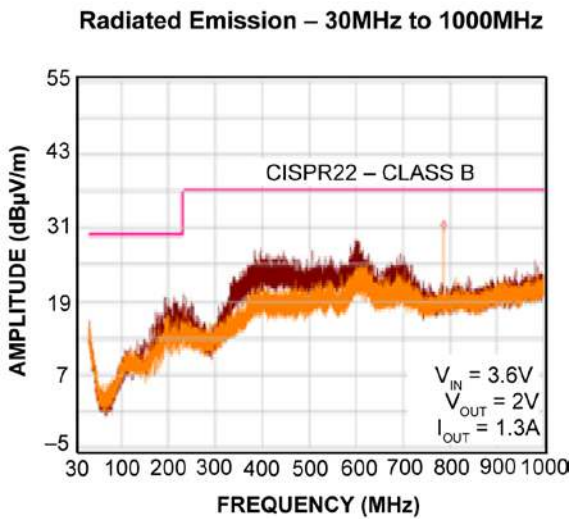
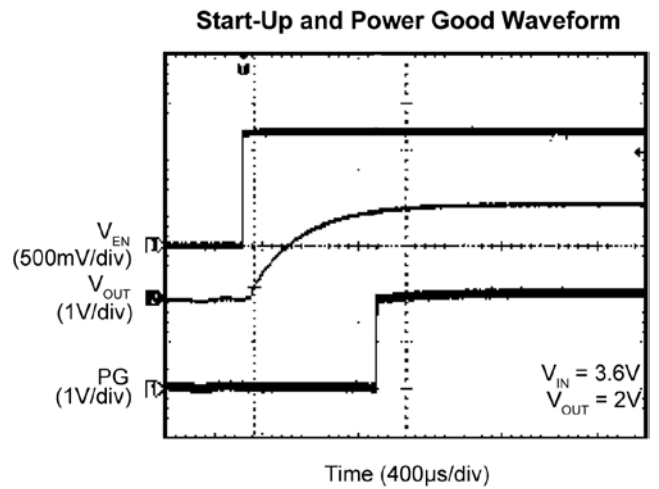
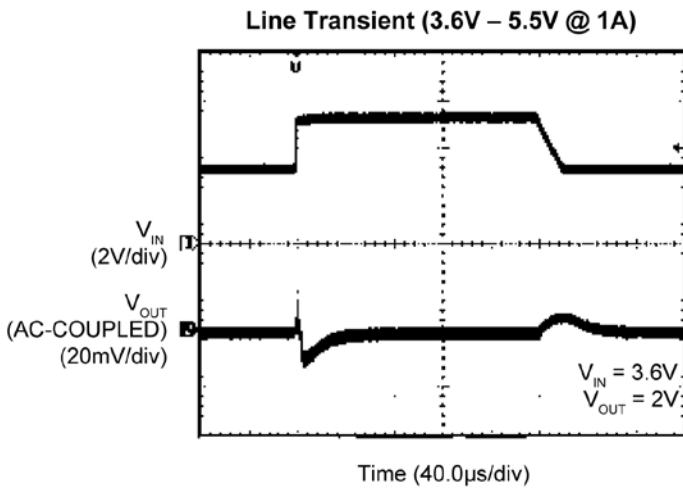
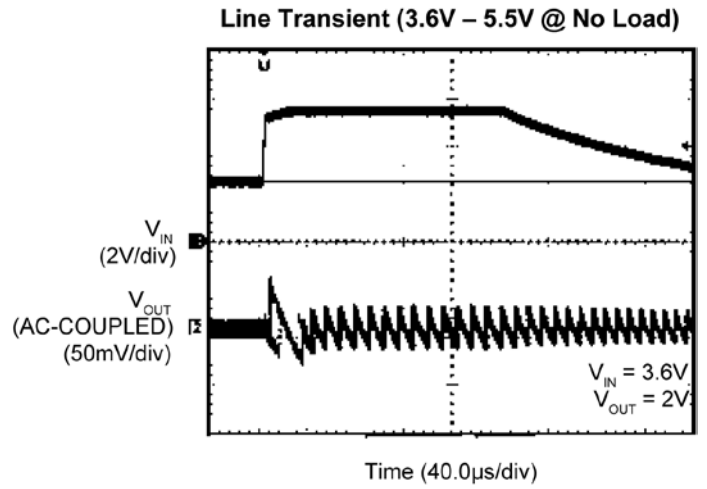
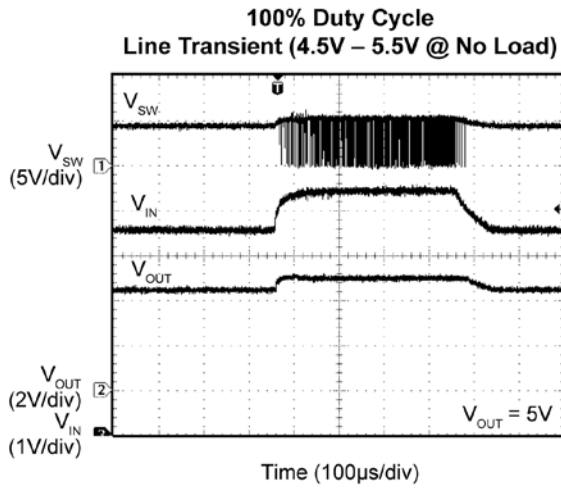

Functional Diagram

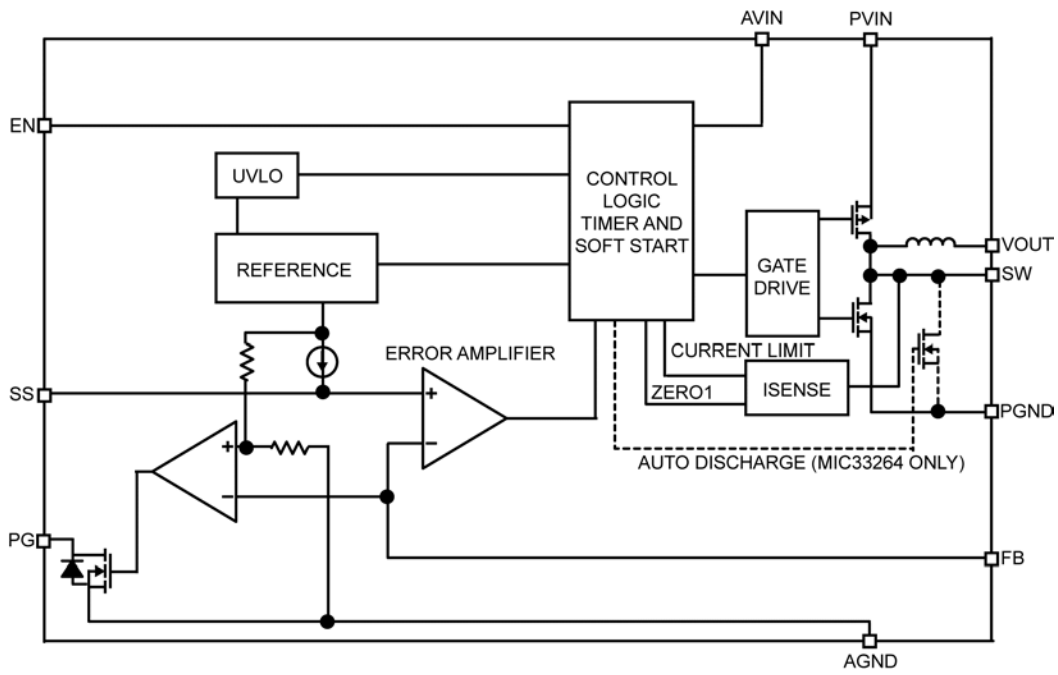

Figure 1. Simplified MIC33263/4 Functional Block Diagram – Adjustable Output Voltage

Functional Description

PVIN

The input supply (PVIN) provides power to the internal MOSFETs for the switch-mode regulator. The PVIN operating input voltage range of 2.7V to 5.5V so an input capacitor, with a minimum voltage rating of 6.3V, is recommended. Due to the high switching speed, a minimum 2.2μF bypass capacitor placed close to PVIN and the power ground (PGND) pin is required. Refer to the PCB Layout Recommendations section for details.

AVIN

Analog VIN (AVIN) provides power to the internal control and analog supply circuitry. AVIN must be tied to PVIN. Careful layout should be considered to ensure that any high-frequency switching noise caused by PVIN is reduced before reaching AVIN. A 1μF capacitor as close to AVIN as possible is recommended. Refer to the PCB Layout Recommendations section for details.

EN/Shutdown

A logic high signal on the enable pin activates the output voltage of the device. A logic low signal on the enable pin deactivates the output and reduces supply current to 0.1μA. When disabled the MIC33264 switches an internal load of 180Ω on the regulators switch node to discharge the output. The MIC33263/4 features external soft-start circuitry adjusted by the soft-start (SS) pin that reduces in-rush current and prevents the output voltage from overshooting at start up. Do not leave the EN pin floating.

SW

The switch (SW) connects to the controller end of integrated inductor. The other end of the inductor is connected to the VOUT pin. Due to the high-speed switching on this pin, the switch node should be not be connected.

VOUT

The output pin (VOUT) connects to the output of integrated inductor. The output capacitor should be connected from this pin to PGND as close to the module as possible. The MIC33263/4 is rated for an output current of up to 2A. A 22μF capacitor is recommended for best performance. Refer to the [PCB Layout Recommendations](#) section for details.

AGND

The analog ground (AGND) is the ground path for the biasing and control circuitry. The current loop for the signal ground should be separate from the power ground (PGND) loop. Refer to the PCB Layout Recommendations section for details.

PGND

The power ground pin is the ground path for the high current in PWM mode. The current loop for the power ground should be as small as possible and separate from the analog ground (AGND) loop as applicable. Refer to the [PCB Layout Recommendations](#) section for details.

PG

The power good (PG) pin is an open drain output which indicates logic high when the output voltage is typically above 90% of its steady state voltage. A pull-up resistor of more than 5kΩ should be connected from PG to VOUT.

SS

The soft-start (SS) pin is used to control the output voltage ramp-up time. Setting CSS to 1nF sets the start-up time to the recommended minimum of approximately 575μs. The start-up time can be determined by Equation 1:

$$T_{SS} = 250 \times 10^3 \times \ln(10) \times C_{SS} \quad \text{Eq. 1}$$

The action of the soft-start capacitor is to control the rise time of the internal reference voltage between 0% and 100% of its nominal steady-state value.

FB

This is the control input for programming the output voltage. A resistor divider network is connected to this pin from the output and is compared to the internal 0.7V reference within the regulation loop.

The output voltage can be programmed between 0.7V and 5V using Equation 2:

$$V_{\text{OUT}} = V_{\text{REF}} \times \left(1 + \frac{R1}{R2} \right) \quad \text{Eq. 2}$$

where:

R1 is the top resistor, R2 is the bottom resistor.

Table 1. Example Feedback Resistor Values

V _{OUT}	R1	R2
1.2V	215k	301k
1.5V	301k	261k
1.8V	340k	215k
2.5V	274k	107k
3.3V	383k	102k
3.6V	422k	102k
5V	634k	102k

Application Information

The MIC33263/4 is a high-performance DC/DC step-down regulator offering a small solution size of 4.6mm × 7mm. Supporting an output current up to 2A inside a tiny 3mm × 2.5mm QFN package, the MIC33263/4 requires very few external components while meeting today's miniature portable electronic device needs. Using the HyperLight Load[®] (HLL) switching scheme, the MIC33263/4 is able to maintain high efficiency throughout the entire load range while providing ultra-fast load transient response. The following sections provide additional device application information.

Input Capacitor

A 2.2μF ceramic capacitor or greater should be placed close to the PVIN pin and PGND pin for bypassing. A TDK C1608X5R0J475M, size 0603, 4.7μF ceramic capacitor is recommended based upon performance, size, and cost. A X5R or X7R temperature rating is recommended for the input capacitor. Y5V temperature rating capacitors, aside from losing most of their capacitance over temperature, can also become resistive at high frequencies. This reduces their ability to filter out high-frequency noise.

Output Capacitor

The MIC33263/4 is designed for use with a 22μF or greater ceramic output capacitor. Increasing the output capacitance will lower output ripple and improve load transient response but could also increase solution size or cost. A low equivalent series resistance (ESR) ceramic output capacitor such as the TDK C1608X5R1A226M080AC, size 0603, 22μF ceramic capacitor is recommended based upon performance, size and cost. Both the X7R or X5R temperature rating capacitors are recommended. The Y5V and Z5U temperature rating capacitors are not recommended due to their wide variation in capacitance over temperature and increased resistance at high frequencies.

Compensation

The MIC33263/4 is designed to be stable with a 22μF ceramic (X5R) output capacitor. An external feedback capacitor of 15pF to 68pF is required for optimum regulation performance.

100% Duty Cycle Low Dropout Operation

The MIC33263/4 enters 100% duty cycle when the input voltage gets close to the nominal output voltage, in this case the high-side MOSFET switch is turned on 100% for one or more cycles. By decreasing the input voltage further the high-side MOSFET switch turns on completely. In this case the small difference between VIN and VOUT is determined by R_{DS(on)} and DCR of the inductor. This is extremely useful in battery-powered applications to accomplish longest operation time.

Efficiency Considerations

Efficiency is defined as the amount of useful output power, divided by the amount of power supplied, as shown in Equation 3:

$$\text{Efficiency \%} = \left(\frac{V_{\text{OUT}} \times I_{\text{OUT}}}{V_{\text{IN}} \times I_{\text{IN}}} \right) \times 100 \quad \text{Eq. 3}$$

Maintaining high efficiency serves two purposes. It reduces power dissipation in the power supply, reducing the need for heat sinks and thermal design considerations and it reduces consumption of current for battery-powered applications. Reduced current draw from a battery increases the device's operating time and is critical in hand held devices.

There are two types of losses in switching converters; DC losses and switching losses. DC losses are simply the power dissipation of I^2R . Power is dissipated in the high side switch during the on cycle. Power loss is equal to the high side MOSFET R_{DS(on)} multiplied by the switch current squared. During the off cycle, the low side N-channel MOSFET conducts, also dissipating power. Device operating current also reduces efficiency. The product of the quiescent (operating) current and the supply voltage represents another DC loss. The current required driving the gates on and off at a constant 4MHz frequency and the switching transitions make up the switching losses.

Figure 2 shows an efficiency curve. From no load to 100mA, efficiency losses are dominated by quiescent current losses, gate drive and transition losses. By using the HLL mode, the MIC33263/4 is able to maintain high efficiency at low output currents.

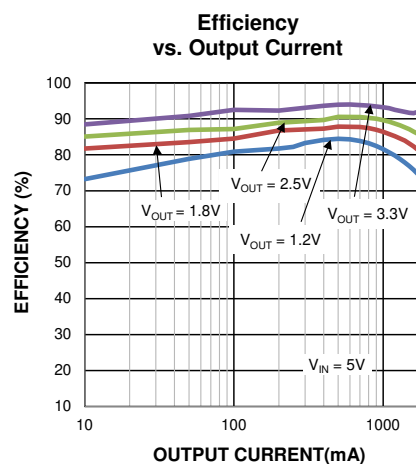

Figure 2. Efficiency under Load

Over 100mA, efficiency loss is dominated by MOSFET $R_{DS(ON)}$ and inductor losses. Higher input supply voltages will increase the gate-to-source threshold on the internal MOSFETs, thereby reducing the internal $R_{DS(ON)}$. This improves efficiency by reducing DC losses in the device.

HyperLight Load[®] Mode (HLL)

MIC33263/4 uses a minimum on and off time proprietary control loop (PCL) patented by Micrel called HyperLight Load[®] (HLL). When the output voltage falls below the regulation threshold, the error comparator begins a switching cycle that turns the PMOS on and keeps it on for the duration of the minimum-on-time. This increases the output voltage. If the output voltage is over the regulation threshold, then the error comparator turns the PMOS off for a minimum-off-time until the output drops below the threshold. The NMOS acts as an ideal rectifier that conducts when the PMOS is off. Using a NMOS switch instead of a diode allows for lower voltage drop across the switching device when it is on. The asynchronous switching combination between the PMOS and the NMOS allows the control loop to work in discontinuous mode for light load operations. In discontinuous mode, the MIC33263/4 works in pulse frequency modulation (PFM) to regulate the output. As the output current increases, the off-time decreases, thus provides more energy to the output. This switching scheme improves the efficiency of MIC33263/4 during light load currents by only switching when it is needed. As the load current increases, the MIC33263/4 goes into continuous conduction mode (CCM) and switches at a frequency centered at 4MHz.

As shown in [Figure 3](#), as the output current increases, the switching frequency also increases until the MIC33263/4 goes from HLL mode to PWM mode at approximately 120mA. The MIC33263/4 will switch at a relatively constant frequency around 4MHz once the output current is over 220mA.

Emission Characteristic of MIC33263/4

The MIC33263/4 integrates switching components in a single package, so the MIC33263/4 has reduced emission compared to standard buck regulator with external MOSFETs and inductors. The radiated EMI scans for MIC33263/4 are shown in the [Functional Characteristics](#). The limit on the graph is per EN55022 class B standard.

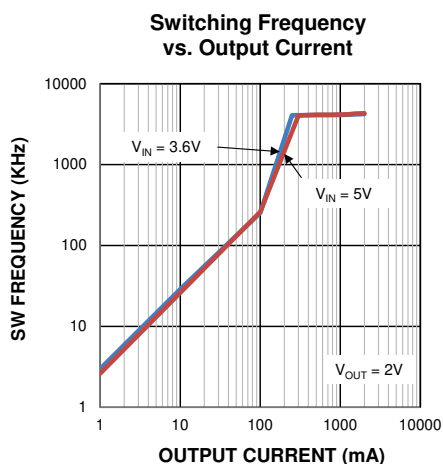
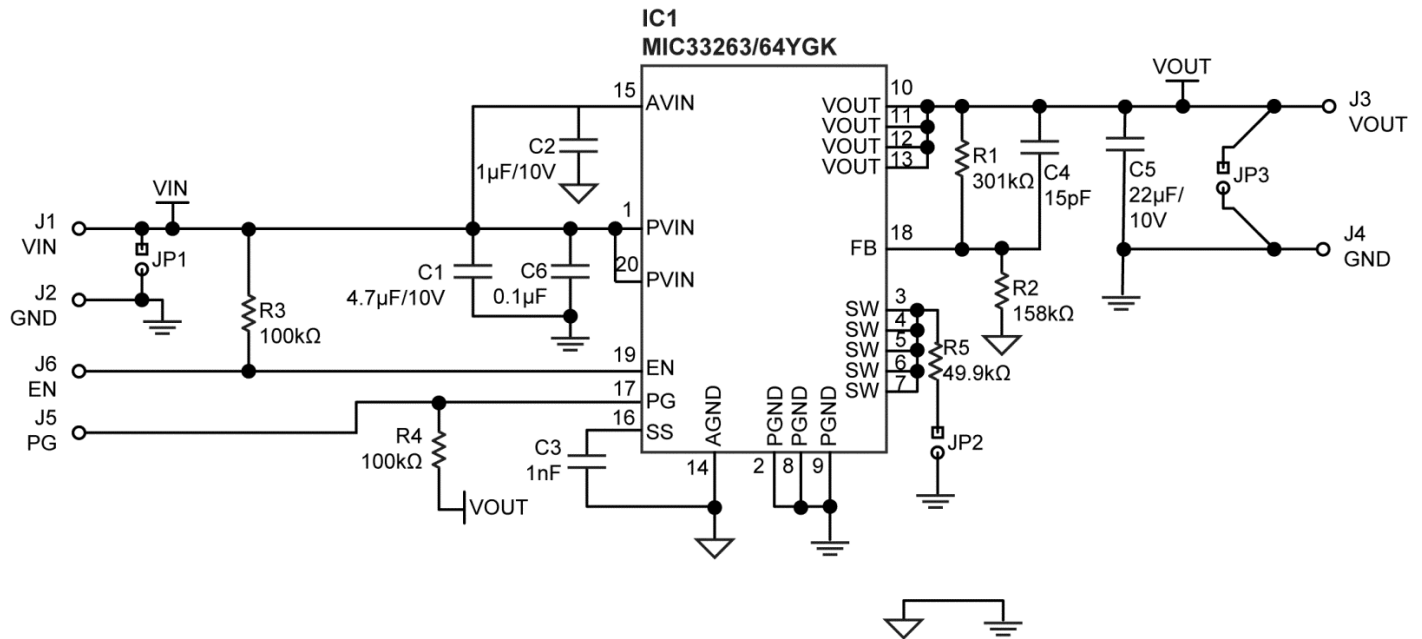

Figure 3. SW Frequency vs. Output

Typical Application Schematic



Bill of Materials

Item	Part Number	Manufacturer	Description	Qty.
C1	C1608X5R1A475K080AC	TDK ⁽⁷⁾	4.7μF, 10V, X5R, Size 0603	1
	GRM188R60J475KE19D	Murata ⁽⁸⁾		
C2	C1608X5R1A105K	TDK	1μF, 10V, X5R, Size 0603	1
C3	C1005C0G1H102J050BA	TDK	1nF, 50V, 0402	1
C4	C1005C0G1H150J050BA	TDK	15pF, 50V, 0402	1
	GRM1555C1H150JZ01D	Murata		
C5	C1608X5R1A226M080AC	TDK	22μF, 10V, X5R, Size 0603	1
R1	CRCW0402301KFKEA	Vishay ⁽⁹⁾	301kΩ, 1%, 1/16W, Size 0402	1
R2	CRCW0402158K0FKEA	Vishay	158kΩ, 1%, 1/16W, Size 0402	1
R3, R4	CRCW0402100KFKEA	Vishay	100kΩ, 1%, 1/16W, Size 0402	1
R5	CRCW040249R9FKED	Vishay	49.9Ω, 1%, 1/16W, Size 0402	1
U1	MIC33263YGK	Micrel, Inc. ⁽¹⁰⁾	4MHz, 2A Buck Regulator with Integrated Inductor and HyperLight Load	1
	MIC33264YGK			

Notes:

7. TDK: www.tdk.com.
8. Murata: www.murata.com.
9. Vishay: www.vishay.com.
10. Micrel, Inc.: www.micrel.com.

PCB Layout Recommendations

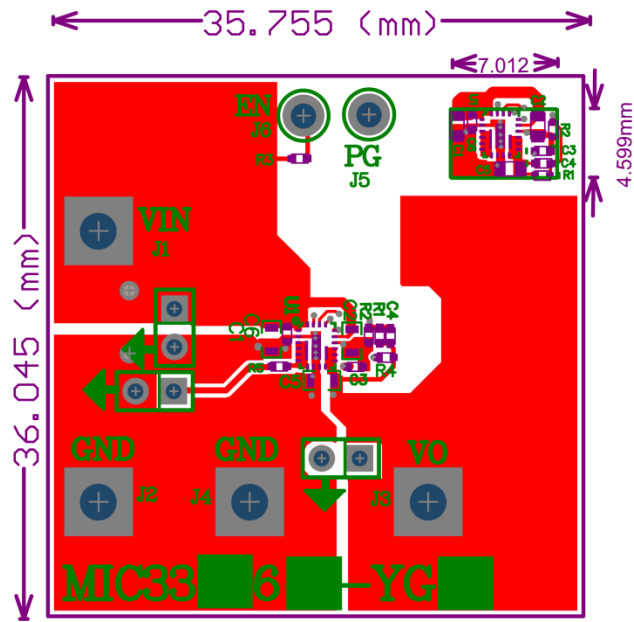

Top Layer

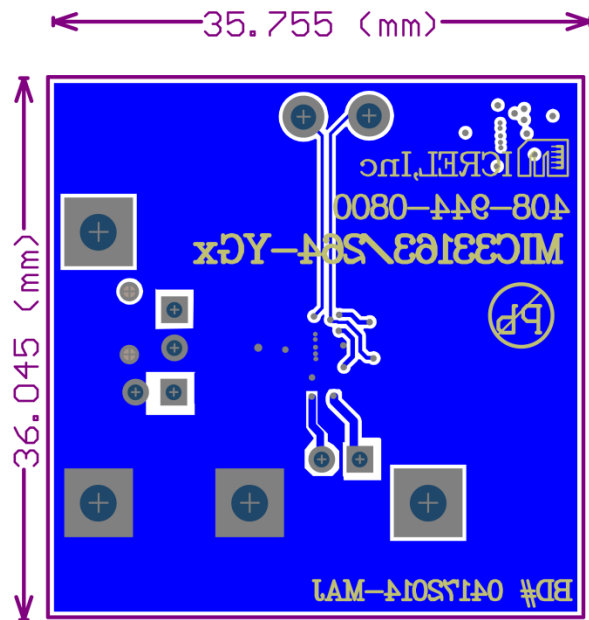

Bottom Layer

Package Information and Recommended Landing Pattern⁽¹¹⁾

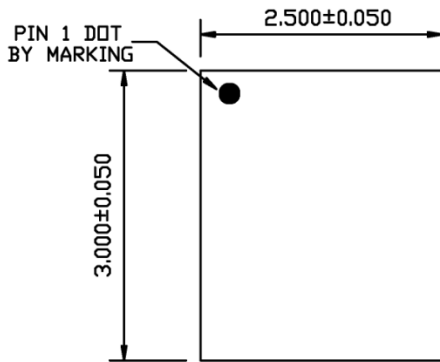

TOP VIEW
NOTE : 1,2,3

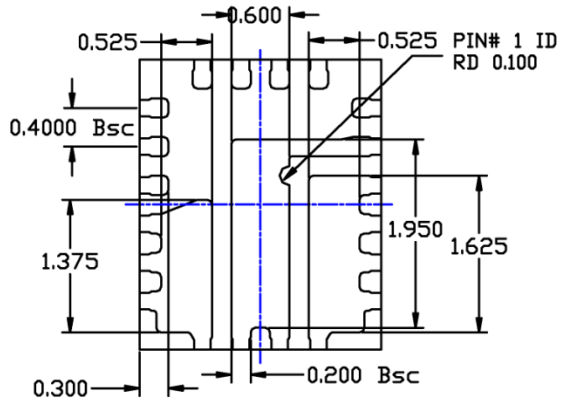

BOTTOM VIEW
NOTE : 1,2,3

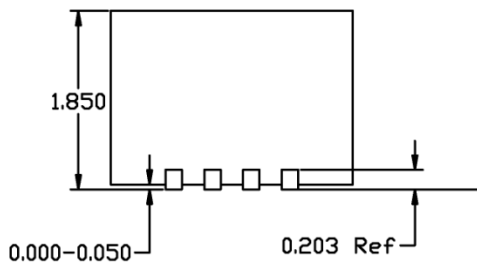

SIDE VIEW
NOTE : 1,2,3

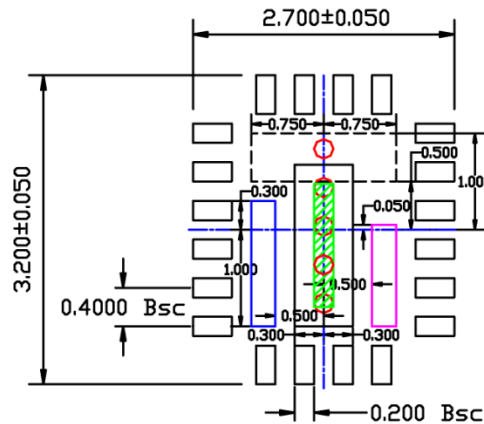

RECOMMENDED LAND PATTERN
NOTE : 4,5,6,7

NOTE :

1. Max package warpage is 0.05mm.
2. Max allowable burr is 0.076mm in all directions.
3. Pin #1 will be laser marked.
4. Red circle in land pattern indicate thermal via. Size should be 0.20mm in diameter, 0.400mm pitch and should be connected to GND for max thermal performance.
5. Green rectangles (shaded area) in GND black colored pad represent stencil opening on exposed area. Size is 0.200x1.475mm.
6. Hidden lines (Optional) for improved thermal performance.
7. Blue & Magenta colored pads represent different potentials, do not connect to GND.

20-Pin 2.5mm x 3mm QFN (GK)

Note:

11. Package information is correct as of the publication date. For updates and most current information, go to www.micrel.com.

MICREL, INC. 2180 FORTUNE DRIVE SAN JOSE, CA 95131 USA
TEL +1 (408) 944-0800 FAX +1 (408) 474-1000 WEB <http://www.micrel.com>

Micrel, Inc. is a leading global manufacturer of IC solutions for the worldwide high-performance linear and power, LAN, and timing & communications markets. The Company's products include advanced mixed-signal, analog & power semiconductors; high-performance communication, clock management, MEMs-based clock oscillators & crystal-less clock generators, Ethernet switches, and physical layer transceiver ICs. Company customers include leading manufacturers of enterprise, consumer, industrial, mobile, telecommunications, automotive, and computer products. Corporation headquarters and state-of-the-art wafer fabrication facilities are located in San Jose, CA, with regional sales and support offices and advanced technology design centers situated throughout the Americas, Europe, and Asia. Additionally, the Company maintains an extensive network of distributors and reps worldwide.

Micrel makes no representations or warranties with respect to the accuracy or completeness of the information furnished in this datasheet. This information is not intended as a warranty and Micrel does not assume responsibility for its use. Micrel reserves the right to change circuitry, specifications and descriptions at any time without notice. No license, whether express, implied, arising by estoppel or otherwise, to any intellectual property rights is granted by this document. Except as provided in Micrel's terms and conditions of sale for such products, Micrel assumes no liability whatsoever, and Micrel disclaims any express or implied warranty relating to the sale and/or use of Micrel products including liability or warranties relating to fitness for a particular purpose, merchantability, or infringement of any patent, copyright, or other intellectual property right.

Micrel Products are not designed or authorized for use as components in life support appliances, devices or systems where malfunction of a product can reasonably be expected to result in personal injury. Life support devices or systems are devices or systems that (a) are intended for surgical implant into the body or (b) support or sustain life, and whose failure to perform can be reasonably expected to result in a significant injury to the user. A Purchaser's use or sale of Micrel Products for use in life support appliances, devices or systems is a Purchaser's own risk and Purchaser agrees to fully indemnify Micrel for any damages resulting from such use or sale.

© 2014 Micrel, Incorporated.