

# XDAC-40U-R4G8

SPECIFICATION SHEET AND MANUAL  
2022

CE RoHS

nicslab

Version: 4.2

Date: 23 November 2022

#### Important Notice and Disclaimer:

No part of this document may be reproduced in any form or by any means (including electronic storage and retrieval or translation into a foreign language) without prior agreement and written consent from Nicslab. No responsibility is assumed by Nicslab for its use, nor for any infringements of patents or other rights of third parties that may result from its use. Trademarks and registered trademarks are the property of their respective owners.

This product is designated for skilled user. You are entirely responsible for (1) choosing the appropriate Nicslab products for your operation, (2) designing, validating and testing your operation, (3) ensuring your operation meets applicable standards, and any other safety, security or other requirements.

Copyright © 2022, Nicslab.

## Safety Note

Do not operate this product in any manner not specified by Nicslab. Failure to comply with these precautions or with specific warnings or instructions elsewhere in this manual violates safety standards of design, manufacture, and intended use of the instrument. Nicslab assumes no responsibility for any damage caused by mishandling that is beyond normal usage defined in this manual of this product.

### Before Applying DC Power Supply

Verify that the DC power supply is good condition and safe to use. It is imperative to use ONE DC power supply as a source power for this product and the input voltage is no more than 36 V or it can impair this product. Make all connections to the unit before applying power.

### Do Not Discard the Instrument Cover

Only authorized personnel from Nicslab should remove the instrument cover.

### Do Not Alter the Instrument

Do not put any unauthorized parts or modify the instrument without Nicslab approval and warranty.

### Caution

This symbol indicates the hazard of any operating procedure, practice, or the like that, if not correctly performed or adhered to, could result in damage to the product or loss of important data.

## Contents

List of Tables	4
List of Figures	4
1. Introduction	5
2. Hardware	7
Specification Conditions	7
Hardware Requirement	7
Box Descriptions	8
XDAC-40U-R4G8 Specifications	11
Hardware Installation	13
3. Software and Graphical User Interface (GUI)	14
Software Requirement	14
Software Installation	14
Graphical User Interface (GUI)	14
Initializing the GUI	17
Premium Upgrade	17
Constant Current Mode (CC Mode)	19
Constant Voltage Mode (CV Mode)	19
Save and Upload	20
Sequence Automation	22
Record	23
Settings	24
Value Increment Setting	25
4. Operating XDAC through SCPI command	26
Python Installation (Example)	26
Run Python Code (Example)	27
Python Function (Example)	29
SCPI Commands	32
5. System Shutdown	35
6. Troubleshooting	36
7. Warranty	37
8. Compliance	37
9. Contact	37

## List of Tables

Table 1. Checklist Items	6
Table 2. Specification Conditions	7
Table 3. DAC Voltage Performance Specification	11
Table 4. DAC Current Performance Specifications	12
Table 5. Troubleshooting	36

## List of Figures

Figure 1. XDAC-40U-R4G8 System Diagram	6
Figure 2. Product Dimension	8
Figure 3. Front and Back Panel	9
Figure 4. GUI	15

# 1. Introduction

Nicslab XDAC-40U-R4G8 system is a versatile multichannel source measurement system. The XDAC-40U-R4G8 supports multiple voltage/current sourcing and voltage/current measurement. The system is suitable for sourcing and measuring low power applications from simple electronic circuits to complex photonic integrated circuits.

The XDAC-40U-R4G8 provides independent 40 channels controlled by Graphical User Interface (GUI) and Standard Commands for Programmable Instruments (SCPI) through an Ethernet port. The system has two modes: Constant Current (CC) ranging from 0 to 300 mA per channel and Constant Voltage (CV) ranging from unipolar 0 – 5 Volt, 0 – 10 Volt, 0 – 20 Volt, and 0 – 36 Volt (please check your feature selection).

The features for XDAC-40U-R4G8 in details are:

- 16-bits voltage control.
- 16-bits current control.
- Enable voltage range configuration through software (technology that enables the user to select the output range with software without lose control of the high-resolution feature).
- Flexible output configuration with 16-bit resolution unipolar 0 – 5 V, 0 – 10 V, 0 – 20 V and 0 – 36 V (*Premium Upgrade*)
- Measurement time for single channel: 55 ms.
- Intuitive GUI.
- Multi-connectors according to your application. (Optional)
- Maximum power output per channel 10 watts.
- Real time voltage and current reading.
- Save function to create a database.
- Upload function to generate the registrable voltage and current pattern.
- Sequence function for continuous voltage and current.
- Short circuits protection.
- SCPI command support (Python, C#, Matlab, and LabVIEW).
- SCPI Library (*Premium Upgrade*).
- Windows, Mac, and Linux support.
- Ethernet Port

The XDAC-40U-R4G8 needs to be connected with direct current (DC) Power then you can plug into the Device-Under-Test (DUT) or multi-connector first. The voltage/current can be controlled through GUI or SCPI command via Ethernet port or USB (Ethernet to USB port converter).

The system diagram is as follow:

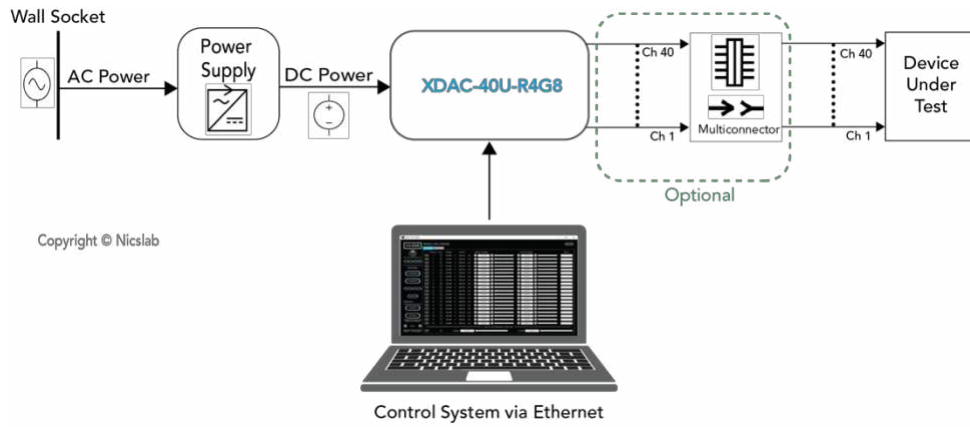

Figure 1. XDAC-40U-R4G8 System Diagram

The package should include the following items:

Table 1. Checklist Items

No	Item	Qty (pc)	Checklist
1	XDAC-40U-R4G8 Box	1	
2	DC power line cord (Red, Green, Black)	3	
3	USB 2.0 to ethernet adapter	1	
4	Multi-connector 1 (Optional)	1	
5	Ribbon rainbow cable (Optional)	2	
6	Ethernet cable	1	
7	USB flash disk	1	
8	Inside USB flash disk: a. GUI b. Specification & Manual c. Test Report d. Serial key (Upgrade) e. XDAC key f. Software Library (Premium) g. Comma-separated values (CSV) template (upload, demo sequence)	1	

## 2. Hardware

### Specification Conditions

The operating and measurement conditions are under the following conditions:

Table 2. Specification Conditions

Items	Conditions
Room Temperature	0 ~ 40 °C
Humidity	5 ~ 80 % (No Condensing)
Power Supply Input	DC Supply Max 36 V (potential at red & black DC in). Power up minimum 36 watt (36 V, 1A power supply setting). Required headroom 1.4 – 2 V.
Waterproof/Dustproof	To be operated under room condition
Calibration period	2 years

### Hardware Requirement

The requirements for the PC/Laptop to be used for this product installation are:

- Resolution Min. 1024 x 768 pixel
- Hard disk Min. 500 MB of available free space (32-bit and 64-bit operating system)
- USB Port USB 2.0
- RAM Min. 2 GB
- CPU 2.4 GHz or faster
- Ethernet port or internet connection via router.



## Box Descriptions

The box size is 232 (W) x 333 (L) x 102 (H) mm, as the pictures below:

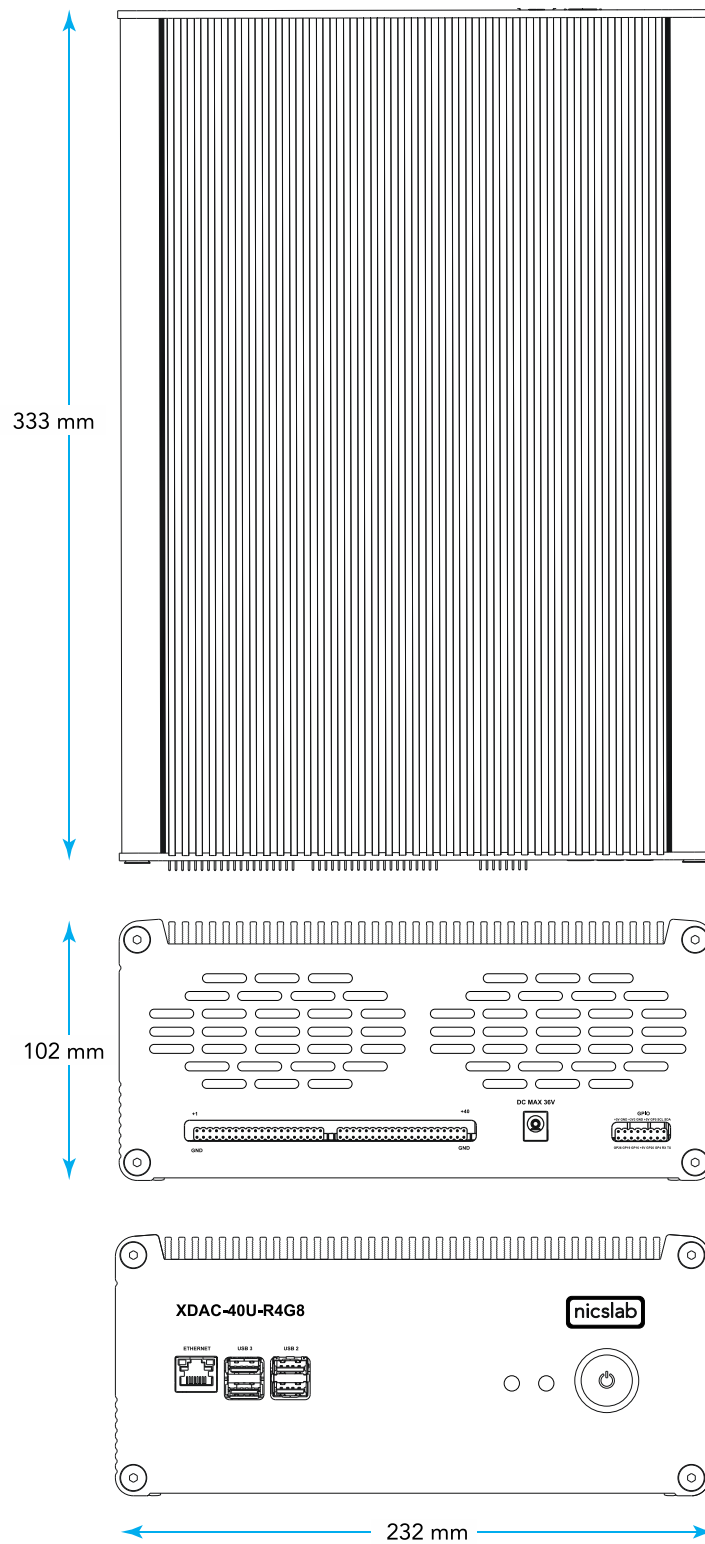

Figure 2. Product Dimension

The details of front and back panel of the box are described below:

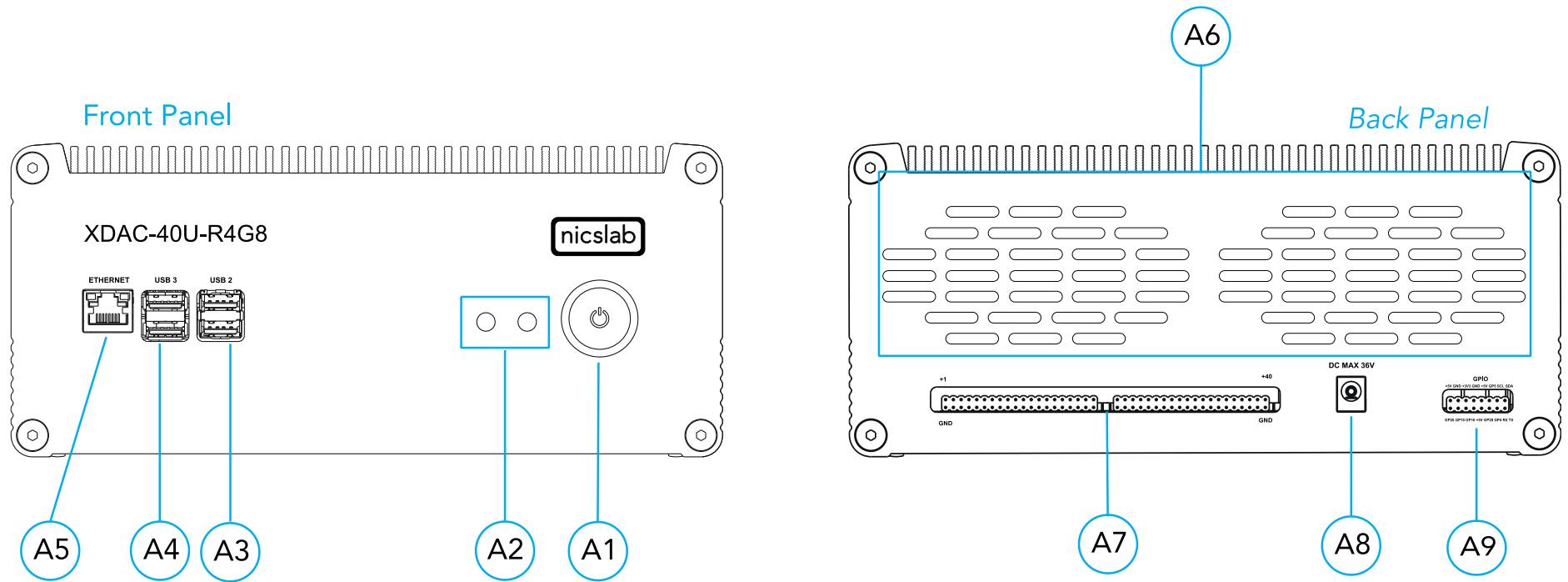

Figure 3. Front and Back Panel

Note:

A1	Power Switch	Turns the instrument on or off. <b>Caution</b> <b>Before turning OFF please close the GUI or type shutdown (SCPI command) to minimize the risk of corrupting the system file (such as data loss).</b>
A2	Indicator Light	<b>Blue</b> -> Power Indicator. <b>Green</b> -> Serial Transfer Data Active.
A3	USB 2	USB port version 2.0.
A4	USB 3	USB port version 3.0.
A5	Ethernet port	Use ethernet cable to connect, or ethernet to USB port converter if the computer doesn't have the ethernet port.
A6	Airflow	For air circulation inside the box.
A7	Pin Output (40 channels)	To connect to Device Under Test (DUT) using cable or multi-connector.
A8	Input DC Max 36V	<b>Caution</b> Please follow the safety notice on your DC power supply. <b>USE ONLY ONE DC POWER SUPPLY</b> and the input is no more than 36V. The XDAC will not power up if the current from the power supply is too low (minimum 1 A). <b>Black</b> cable inserts to GND <b>Red</b> cable inserts to 36 V
A9	GPIO	You may use for external control and monitoring direct to microprocessor.

## XDAC-40U-R4G8 Specifications

The performance specifications of Digital Analog Converter (DAC) voltage are listed in Table 3 below:

Table 3. DAC Voltage Performance Specification

No	Parameter	Min	Typ	Max	Unit	Test conditions/comments
1	Resolution	16			Bits	
2	Integral nonlinearity (INL)	-1	± 0.5	1	LSB	All ranges
3	Differential Nonlinearity (DNL)	-1	± 0.5	1	LSB	Specified 16-bit monotonic
4	Total unadjusted error	-0.1	± 0.01	0.1	%FSR	All ranges
5	Unipolar offset error	-0.03	± 0.015	0.03	%FSR	All unipolar ranges
6	Unipolar zero-code error	0	0.04	0.1	%FSR	All unipolar ranges
7	Full-scale error	-0.2	± 0.075	± 0.2	%FSR	All ranges
8	Gain error	-0.1	± 0.02	0.1	%FSR	All ranges
9	Unipolar offset error drift		±2		ppm of FSR/°C	All unipolar ranges
10	Gain error drift		±2		ppm of FSR/°C	All ranges
11	Output voltage drift over time		5		Ppm of FSR	T <sub>A</sub> = 40 °C, Full-scale code, 1900 hours
DYNAMIC PERFORMANCE						
12	Output Voltage Settling Time		12		µs	¼ to ¾ and ¾ to ¼ scale setting time to ± 1 LSB, ±10 V range, R <sub>L</sub> = 5k Ω, C <sub>L</sub> = 200 pF
13	Slew Rate		4		V/µs	All range except 0 to 5 V
14	Power-on glitch magnitude		0.3		V	Power-down to active DAC output, ±20 V range, Midscale code, R <sub>L</sub> = 5 kΩ, C <sub>L</sub> = 200 pF
15	Output noise		15		µV p-p	0.1 Hz to 10 Hz, Midscale code, 0 to 5 V range
16	Output noise density		78		nV/√Hz	1 kHz, Midscale code, 0 to 5 V range
17	AC PSRR		1		LSB/V	Midscale code, frequency = 60 Hz, amplitude 200 mVpp superimposed on V <sub>DD</sub> , V <sub>CC</sub> or V <sub>SS</sub>
18	DC PSRR		1		LSB/V	Midscale code, V <sub>DD</sub> = 5V, V <sub>CC</sub> = 20 V ±5 %, V <sub>SS</sub> = 20 V
19	Code change glitch impulse		4		nV-s	1 LSB change around major carrier, 0 to 5 V range
20	Channel to Channel AC crosstalk		4		nV-s	0 to 5 V range. Measured channel at midscale. Full-scale swing on all other channels.
21	Channel to Channel DC crosstalk		0.25		LSB	0 to 5 V range. Measured channel at midscale. All other channels at full-scale.
22	Digital feedthrough		1		nV-s	0 to 5 V range, Midscale code, F <sub>SCLK</sub> = 1 MHz

The performance specifications of Digital Analog Converter (DAC) current are listed in Table 4 below:

Table 4. DAC Current Performance Specifications

No	Parameter	Min	Typ	Max	Unit	Test conditions/comments
1	Resolution	16			Bits	
2	Monotonicity	16			Bits	
3	Differential Nonlinearity		± 0.2	± 1	LSB	
4	Integral Nonlinearity		± 12	± 64	LSB	
5	Offset Error Current		± 0.1	± 0.4	%FSR	
6	V= Temperature Coefficient		± 10		ppm/°C	
7	Gain Error		± 0.3	± 0.9	%FSR	300 mA Range
8	Gain Temperature Coefficient		30		%FSR	FSADJ = VCC
9	Total Unadjusted Error		± 0.4	± 1.4	%FSR	300 mA Range
10	Power Supply Rejection Ratio		± 2.2		LSB	100 mA; IO <sub>UT</sub> = 50 mA
11	DC Crosstalk		±14		LSB	Due to 200 mW Change in Dissipated Power
12	DC Performance					
13	VDROPOUT		1.15	1.751	V	300 mA Range
14	Hi-Z Output Leakage Current		0.1	1	µA	
AC CHARACTERISTIC						
16	t <sub>SET</sub>		4.7		µs	Settling time, Full-Scale 200 mA range
17	Glitch Impulse		180		pA.s	At Mid-Scale Transition, 200 mA Range
18	DAC-to-DAC Crosstalk		150		pA.s	100 mA to 200 mA Step, R <sub>load</sub> = 15 Ω
19	I <sub>noise</sub>					Output Current Noise Density Internal Reference, I <sub>out</sub> = 150 mA, R <sub>load</sub> = 4 Ω, C <sub>load</sub> = 10 µF
20			12			f = 1 kHz
21			5		nA√Hz	f = 10 kHz
22			0.5	n	nA√Hz	f = 100 kHz
23			0.05		nA√Hz	f = 1 MHz

## Hardware Installation

This section describes how to install XDAC-40U-R4G8 and how to connect your Device Under Test (DUT) to the output terminals.

The steps are as follow:

1. Precondition step: connect to the DC power supply (max 36 V). Make certain that DC power supply is always 'ON'.
2. Connect an Ethernet cable to your workstation (PC/Laptop) via Ethernet Port or USB 2.0 Ethernet Network Adapter.
3. Install the software/GUI (see the [Software Installation](#) section) from the flash disk or Dropbox link.
4. Turn ON the switch.
5. Wait until there is **Blue** light (the system is ready to use).
6. You may now open the GUI (**Green** light means serial data transfer active).
7. Connect XDAC output to your Device Under Test (DUT).

### 3. Software and Graphical User Interface (GUI)

#### Software Requirement

The GUI software is suitable with the following operating systems:

- Windows® 7 (32-bit, 62-bit).
- Windows® 10 (32-bit, 62-bit).
- Windows® 11 (64-bit).
- macOS Big Sur.

#### Software Installation

The first step is to install the XDAC\_setup.exe file into your computer and then double-click to launch the GUI. The icon is as below:



At the end step of the installation, check a 'Create a desktop shortcut'.

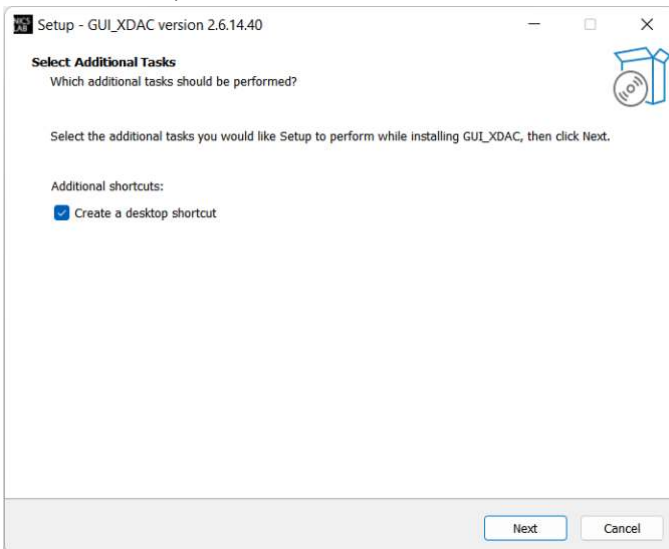

Double-click the executable GUI icon (as shown below) on your desktop to launch the GUI.



#### Graphical User Interface (GUI)

Start the XDAC by pressing the ON button, then you can control it by GUI. the display details are on the next page.

First, set up the connection to your instruments by entering the IP address. Please scan the XDAC IP address to know the XDAC IP. The XDAC IP address should appear if you scan it in the local network using IP scanner such as Angry IP scanner or NMAP.

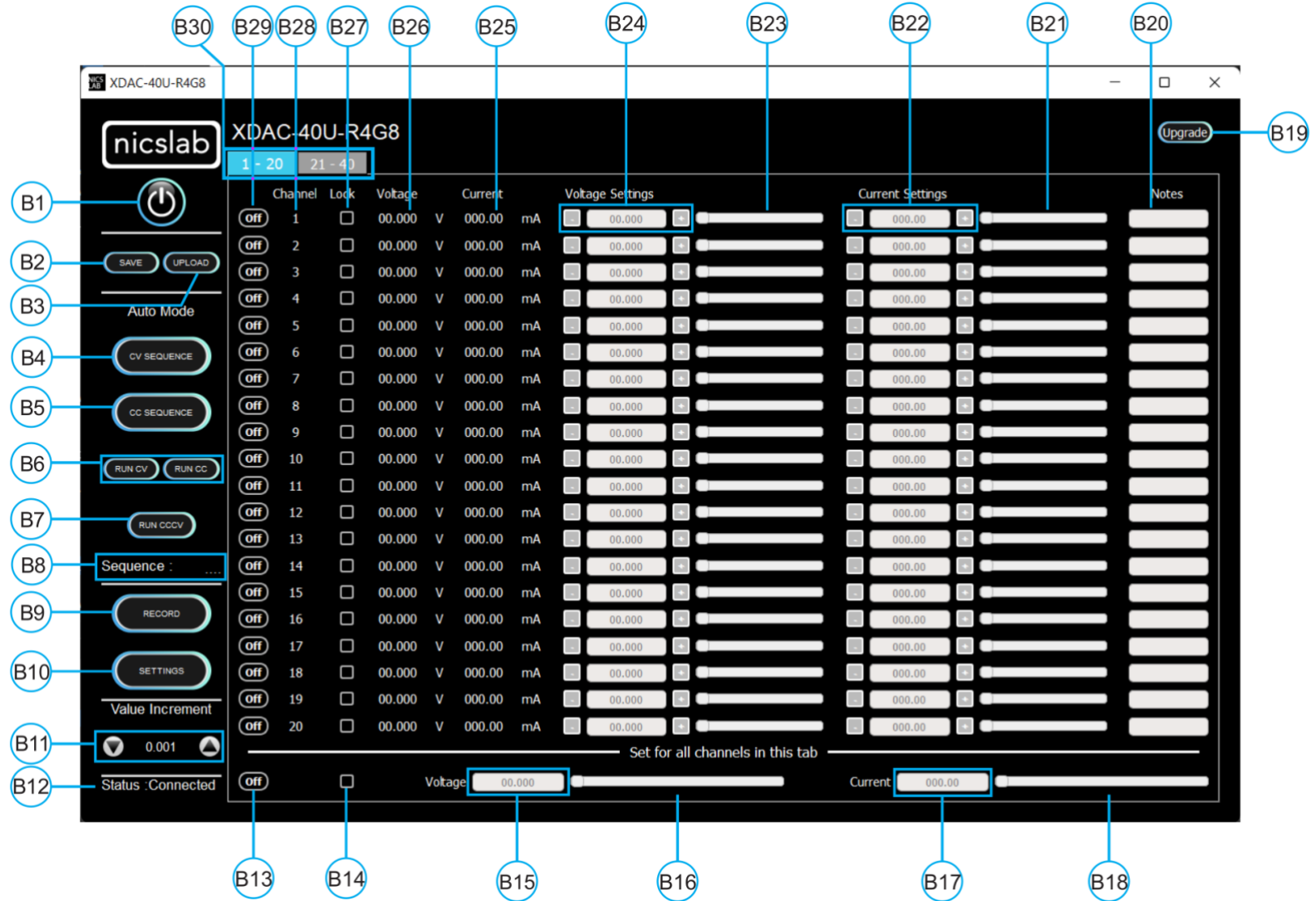

Figure 4. GUI



Note:

Callout	Description
B1	ON/OFF Switch
B2	Save File Button - <i>Premium Feature</i>
B3	Upload File Button - <i>Premium Feature</i>
B4	Auto Feature Sequence: Upload Table Button   CV Mode - <i>Premium Feature</i>
B5	Auto Feature Sequence: Upload Table Button   CC Mode - <i>Premium Feature</i>
B6	Auto Feature: Run Button CV and CC Mode separately - <i>Premium Feature</i>
B7	Auto Feature: Run Button CV and CC Mode combined - <i>Premium Feature</i>
B8	Name of the Sequence - <i>Premium Feature</i>
B9	Record Data Button - <i>Premium Feature</i>
B10	Setting for: <ol style="list-style-type: none"> <li>1. Set Limit voltage and current values - <i>Premium Feature</i></li> <li>2. V Range (16-bit precision for every range of voltages: 5, 10, 20, 36 V) - <i>Premium Feature</i></li> <li>3. Set Reading speed of Voltage and Current (Fast, Medium, Slow) - <i>Premium Feature</i></li> </ol>
B11	Increment Settings
B12	Status of connection
B13	ON/OFF Button for the current Tab
B14	Enable/Disable (Lock) Channel Controller for all channels in current tab
B15	Text area to set the voltage for all channels in current tab
B16	Slider to set voltage for all channels in current tab
B17	Text area to set the current for all channels in current tab
B18	Slider to set current for all channels in current tab
B19	Upgrade Button
B20	Notes - <i>Premium Feature</i>
B21	Current Settings Slider
B22	Current Value Based on Increment Setting
B23	Voltage Settings Slider
B24	Voltage Value Based on Increment Setting
B25	Current Value
B26	Voltage Value
B27	Enable/Disable (Lock) Channel Controller
B28	Number of channels
B29	ON/OFF Button per Channel
B30	Tab Channel

## Initializing the GUI

This section shows how to initialize the GUI:

1. Launch the program by double-clicking the "XDAC\_setup\_exe" icon.
2. Enter XDAC's IP address and XDAC key as given. If the connection is successful, then the GUI will open and there is the **Green** indicator light.

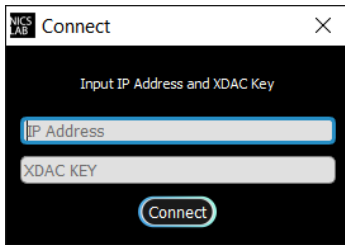

3. Press the 'ON/OFF' button (B1) to start the GUI.



4. Turn ON (B29) on each channel to the input voltage and current values.

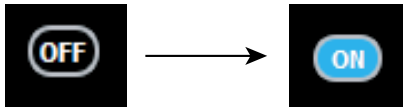

## Premium Upgrade

This section shows how to upgrade the GUI to enable advanced features.

1. Press the upgrade button at the top right corner of the window

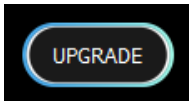

2. After the upgrade window opened, input the Premium Upgrade Key.

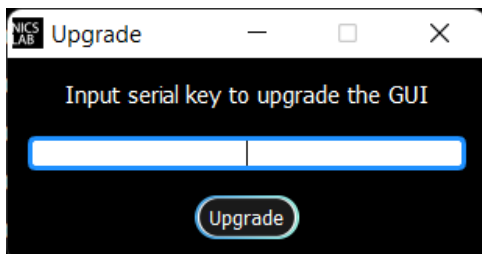

3. If your Premium Upgrade Key is valid, you will get a message that indicates a successful upgrade.

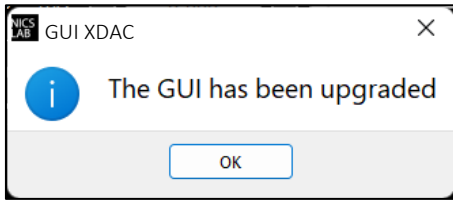

4. You can use several features that were previously locked
- Save
  - Upload
  - CV Mode
  - CC Mode
  - CCvCV Mode
  - Record
  - Setting
    - Set Limit Voltage
    - Set Limit Current
    - Set Voltage Range
  - Notes

The next few sections are the advanced features that are enabled after upgrading the GUI.

## Constant Current Mode (CC Mode)

This section shows how to do CC mode according to your purpose:

To do CC mode, you need to move the voltage slider (B23) or adjust voltage value (B24) to a certain value before setting the current value on (B22) or slider (B21). As an example, channel 1 in the below picture was given 100  $\Omega$  load.

**Important note:** When you manually input the values, always press 'Enter'.

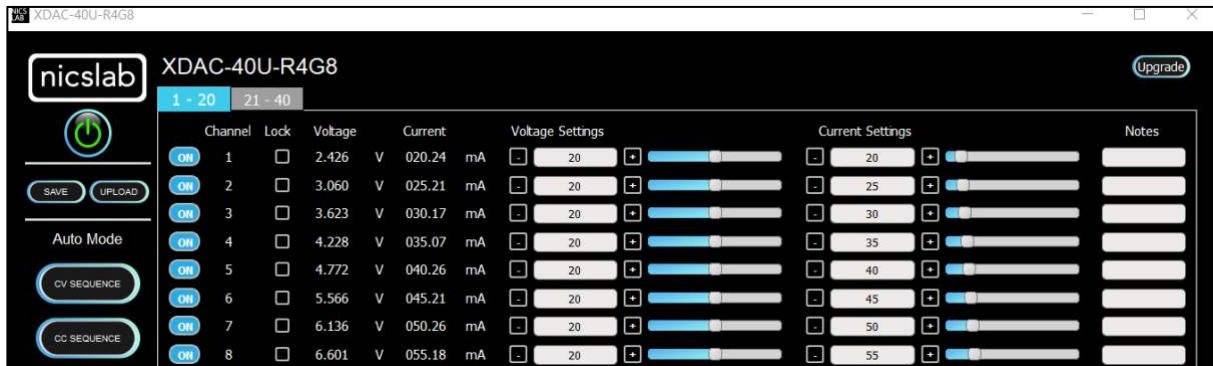

## Constant Voltage Mode (CV Mode)

This section shows how to do CV mode according to your aim:

To do CV mode, you need to move the current slider (B21) or adjust the current value (B22) to a certain value. Then adjust the voltage value on (B24) or slider (B23).

**Important note:** When you manually input the values, always press 'Enter'.

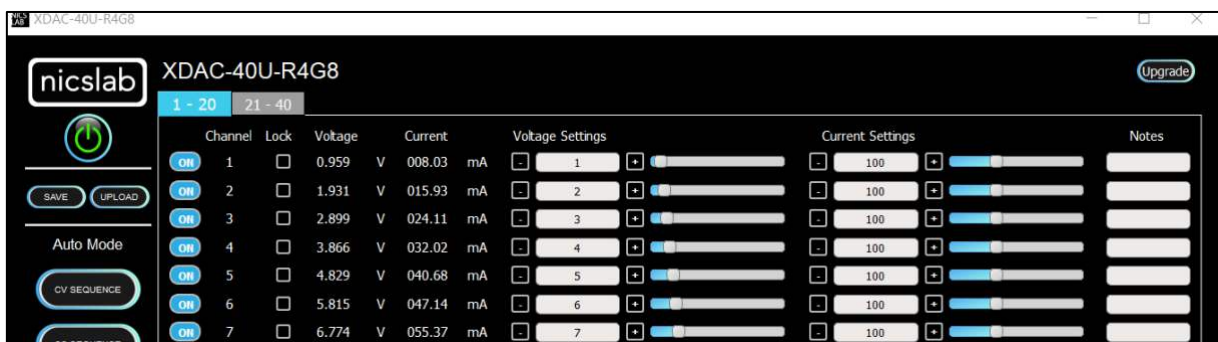

## Save and Upload

The CSV file (.csv) resulting from the Save function can be uploaded again through the Upload button (B3). You may also create your own CSV file of voltage and current and upload it later.

1. To save the configuration, click the 'Save' button (B2).



2. Select a directory and write the file name.

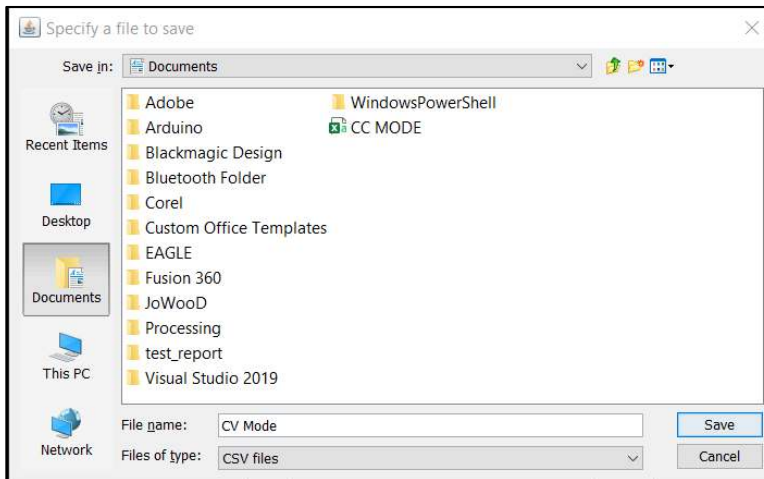

3. The file will be saved as a .csv file.
4. Check the .csv file that you have saved.

A screenshot of an Excel spreadsheet titled 'voltage'. The spreadsheet has columns for 'voltage', 'current', and 'note'. The data is recorded in rows 1 through 19. The 'voltage' column contains values from 1 to 19, and the 'current' column contains values from 150 to 150. The 'note' column is empty.

	A	B	C	D	E	F	G	H
1	voltage	current	note					
2	1	150						
3	2	150						
4	3	150						
5	4	150						
6	5	150						
7	6	150						
8	7	150						
9	8	150						
10	1.1	150						
11	2.2	150						
12	3.3	150						
13	4.4	150						
14	5.5	150						
15	6.6	150						
16	7.7	150						
17	8.8	150						
18	1.23	150						
19	2.34	150						

The voltage, current, and notes are recorded.

5. To upload the configuration, click the 'Upload' button (B3).



6. Choose and open the intended file.

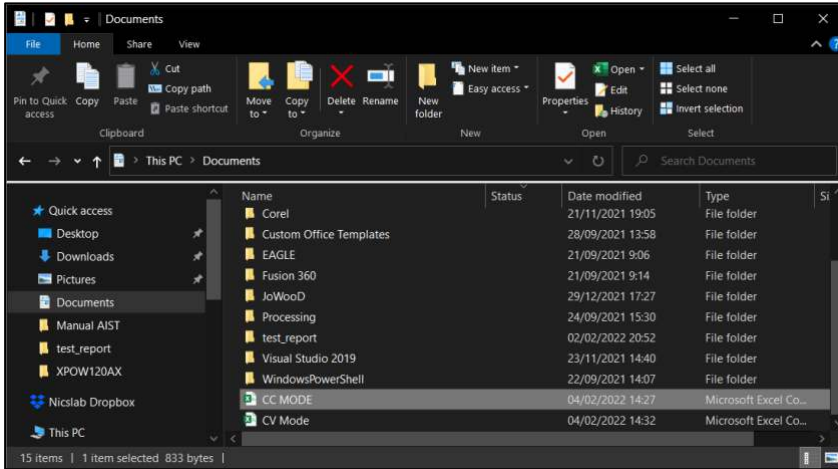

7. It will upload the configuration like the previous configuration.

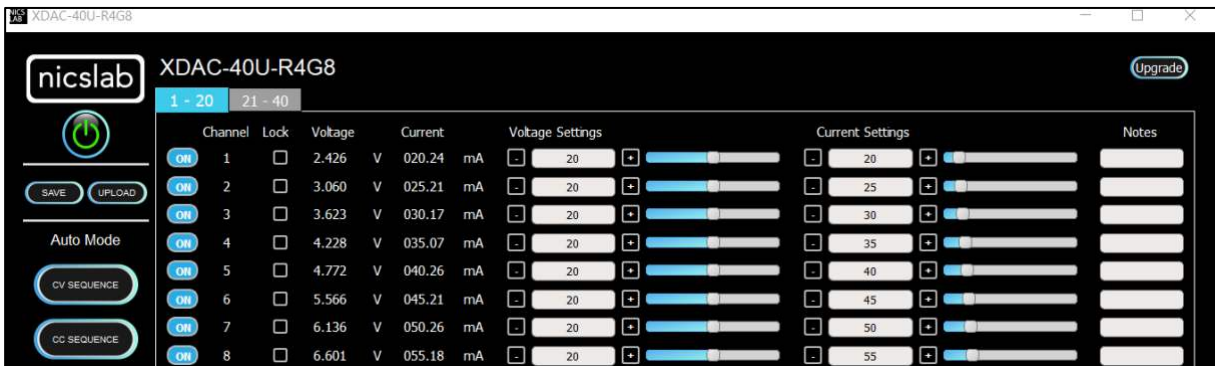

Note: When you upload CV mode, the current setting slider values automatically show 2184.50 bits to open the current flow from the supply. You may adjust this to match your requirements.

## Sequence Automation

Sequence is the setting that automates the determined values of current (mA) or voltage (V) given the certain Delay Time (in milliseconds).

- The template of the sequence is given, then you need to input your intended values of CC Sequence (from 0 to 300 mA), CV Sequence (from 0 to 36 V), and Delay Time (in milliseconds). Set the delay time to more than 2 seconds to have more accurate values. To have a faster response (switching time) you can set it via the SCPI command (see **Error! Reference source not found.**).

	A	B	C	D	E	F	G	H	I	J
1		Seq 1	Seq 2	Seq 3	Seq 4	Seq 5	Seq 6	Seq 7	Seq 8	Note
2	Delay Time	6000	5478	4912	3409	4213	5902	6012		
3	Channel 1	5	50	0	100	150	150	0	300	Fan1
4	Channel 2	10	50	0	100	160	150	0	300	Fan2
5	Channel 3	15	50	0	100	170	150	0	300	Motor1
6	Channel 4	20	50	0	100	180	150	0	300	Motor2
7	Channel 5	25	50	0	100	190	150	0	300	Sensor1
8	Channel 6	30	50	0	100	200	150	0	300	Sensor2
9	Channel 7	35	50	0	100	210	150	0	300	Sensor3
10	Channel 8	40	50	0	100	220	150	0	300	Not Used

Note:

- Template given for CC and CV sequences.
  - Input your intended values according to the modes (CC: 0 – 300 mA, CV: 0 – 36 V).
- Choose the sequence mode that you will use, either CV Sequence (B4) or CC sequence (B5). When you click, for example, if you want to use a CC sequence, you need to open the corresponding CSV sequence file.
  - After uploading, choose sequence mode by clicking either 'Run CV' (B6 - Mode for CV sequence), 'Run CC' (B6 - Mode for CC sequence), or 'Run CCCV' (B7 – Mode for both CC and CV sequences).

**Important note:** when 'Run CCCV' use the same delay time on the template .csv of CC and CV sequence.

## Record

'Record' (B9) keeps data of voltage and current values. The record starts by the time you click the Record button and finish until you click again the same button. The Excel file (.csv) will be created automatically in the same folder as XDAC's GUI file.



Click the same button to stop Recording. After that, put the file in any directory

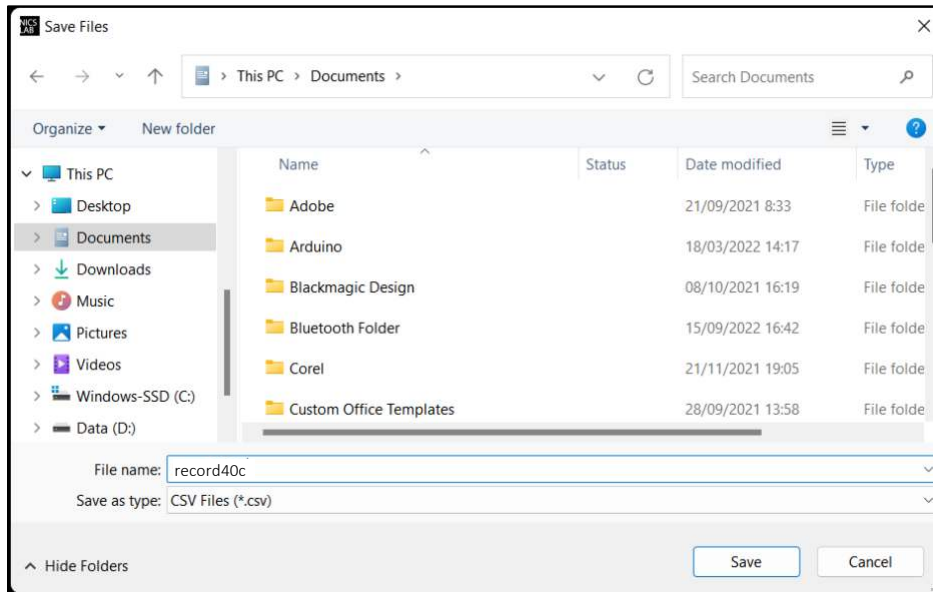

This is the output of recorded file

Time Stamp	Voltage[1]	Current[1]	Notes	Voltage[2]	Current[2]	Notes	Voltage[3]	Current[3]	Notes	Voltage[4]	Current[4]	Notes	Voltage[5]	Current[5]	Notes	Voltage[6]	Current[6]	Notes
20:29:19	1.111 V	9.1 mA	Fan1	1.053 V	9.17 mA	Fan2	1.125 V	9.12 mA	Motor1	1.107 V	9.12 mA	Motor2	1.099 V	9.07 mA	Sensor1	1.112 V	9.05 n	
20:29:20	1.111 V	9.07 mA	Fan1	1.053 V	9.17 mA	Fan2	1.125 V	9.12 mA	Motor1	1.107 V	9.12 mA	Motor2	1.099 V	9.07 mA	Sensor1	1.112 V	9.05 n	
20:29:21	1.111 V	9.1 mA	Fan1	1.053 V	9.17 mA	Fan2	1.125 V	9.12 mA	Motor1	1.107 V	9.12 mA	Motor2	1.1 V	9.07 mA	Sensor1	1.112 V	9.05 n	
20:29:22	1.111 V	9.1 mA	Fan1	1.053 V	9.17 mA	Fan2	1.125 V	9.12 mA	Motor1	1.107 V	9.12 mA	Motor2	1.099 V	9.07 mA	Sensor1	1.112 V	9.05 n	
20:29:23	1.111 V	9.1 mA	Fan1	1.053 V	9.17 mA	Fan2	1.125 V	9.12 mA	Motor1	1.107 V	9.12 mA	Motor2	1.1 V	9.07 mA	Sensor1	1.112 V	9.05 n	
20:29:24	1.111 V	9.1 mA	Fan1	1.053 V	9.17 mA	Fan2	1.125 V	9.12 mA	Motor1	1.107 V	9.12 mA	Motor2	1.1 V	9.07 mA	Sensor1	1.112 V	9.05 n	
20:29:25	8.716 V	71.8 mA	Fan1	1.054 V	9.17 mA	Fan2	1.125 V	9.12 mA	Motor1	1.107 V	9.12 mA	Motor2	1.1 V	9.07 mA	Sensor1	1.112 V	9.05 n	
20:29:26	8.716 V	71.8 mA	Fan1	1.054 V	9.17 mA	Fan2	1.125 V	9.12 mA	Motor1	1.107 V	9.12 mA	Motor2	1.1 V	9.07 mA	Sensor1	1.112 V	9.05 n	
20:29:27	8.716 V	71.8 mA	Fan1	1.054 V	9.17 mA	Fan2	1.125 V	9.12 mA	Motor1	1.107 V	9.12 mA	Motor2	1.1 V	9.07 mA	Sensor1	1.112 V	9.05 n	
20:29:28	8.716 V	71.8 mA	Fan1	8.699 V	76.37 mA	Fan2	1.125 V	9.12 mA	Motor1	1.109 V	9.15 mA	Motor2	1.1 V	9.07 mA	Sensor1	1.112 V	9.05 n	
20:29:29	8.717 V	71.8 mA	Fan1	8.699 V	76.35 mA	Fan2	1.125 V	9.12 mA	Motor1	1.109 V	9.15 mA	Motor2	1.1 V	9.07 mA	Sensor1	1.112 V	9.05 n	
20:29:30	8.717 V	71.8 mA	Fan1	8.699 V	76.35 mA	Fan2	1.125 V	9.12 mA	Motor1	1.109 V	9.15 mA	Motor2	1.1 V	9.07 mA	Sensor1	1.112 V	9.05 n	
20:29:31	8.717 V	71.8 mA	Fan1	8.699 V	76.35 mA	Fan2	1.372 V	11.15 mA	Motor1	1.109 V	9.15 mA	Motor2	1.1 V	9.07 mA	Sensor1	1.112 V	9.05 n	
20:29:32	8.717 V	71.8 mA	Fan1	8.699 V	76.35 mA	Fan2	1.372 V	11.15 mA	Motor1	1.109 V	9.15 mA	Motor2	1.1 V	9.07 mA	Sensor1	1.112 V	9.05 n	
20:29:33	8.717 V	71.8 mA	Fan1	8.699 V	76.35 mA	Fan2	1.372 V	11.15 mA	Motor1	1.475 V	12.2 mA	Motor2	1.1 V	9.07 mA	Sensor1	1.114 V	9.05 n	
20:29:34	8.716 V	71.8 mA	Fan1	8.699 V	76.35 mA	Fan2	1.372 V	11.15 mA	Motor1	1.474 V	12.2 mA	Motor2	1.1 V	9.07 mA	Sensor1	1.112 V	9.05 n	
20:29:35	8.717 V	71.8 mA	Fan1	8.699 V	76.35 mA	Fan2	1.372 V	11.15 mA	Motor1	1.475 V	12.2 mA	Motor2	2.148 V	17.75 mA	Sensor1	1.114 V	9.05 n	
20:29:36	8.716 V	71.77 mA	Fan1	8.699 V	76.35 mA	Fan2	1.372 V	11.15 mA	Motor1	1.475 V	12.2 mA	Motor2	2.441 V	20.22 mA	Sensor1	1.72 V	13.82	
20:29:37	8.716 V	71.77 mA	Fan1	8.699 V	76.35 mA	Fan2	1.372 V	11.15 mA	Motor1	1.475 V	12.2 mA	Motor2	2.441 V	20.22 mA	Sensor1	3.7 V	30.27	
20:29:38	8.716 V	71.77 mA	Fan1	8.699 V	76.35 mA	Fan2	1.372 V	11.15 mA	Motor1	1.475 V	12.2 mA	Motor2	2.441 V	20.22 mA	Sensor1	3.7 V	30.27	



## Settings

Click the 'Settings' button (B10).



The 'Settings' feature consists of:

- set maximum limit for both current and/or voltage values
- set range for voltage values where you can choose the voltage range to limit the voltage values (B23, B24, and B26), the range of voltages are 0 – 5 V, 0 – 10 V, 0 – 20 V, and 0 – 36 V. Each range has 16-bit precision.
- set reading speed to adjust different speed for reading voltage and current. The speed is based on averaging number of sample output values. Faster options can make conversion time smaller but the results noisier.

**Set current limit**

The dialog box shows a table for setting current limits for 20 channels. The main interface shows the 'Current' column with values ranging from 0.0100 mA to 100.42 mA.

Channel	Lock	Voltage	Current	Voltage Settings	Current Settings	Notes
1	<input type="checkbox"/>	1.229 V	0.0100 mA	1.2000	10.00	
2	<input type="checkbox"/>	2.459 V	0.0041 mA	2.2000	20.00	
3	<input type="checkbox"/>	3.098 V	0.0251 mA	3.2000	25.50	
4	<input type="checkbox"/>	3.632 V	0.3022 mA	4.0000	30.00	
5	<input type="checkbox"/>	4.187 V	0.3561 mA	4.2000	35.00	
6	<input type="checkbox"/>	4.818 V	0.3957 mA	5.0000	39.00	
7	<input type="checkbox"/>	4.981 V	0.4101 mA	5.2000	40.50	
8	<input type="checkbox"/>	5.999 V	0.5034 mA	6.0000	50.00	
9	<input type="checkbox"/>	6.723 V	0.5629 mA	7.0000	55.00	
10	<input type="checkbox"/>	7.569 V	0.6202 mA	8.0000	61.20	
11	<input type="checkbox"/>	8.495 V	0.7058 mA	8.2000	70.00	
12	<input type="checkbox"/>	8.900 V	0.7397 mA	9.0000	75.20	
13	<input type="checkbox"/>	9.900 V	0.8192 mA	10.0000	81.00	
14	<input type="checkbox"/>	10.349 V	0.8569 mA	11.0000	85.00	
15	<input type="checkbox"/>	10.768 V	0.8892 mA	12.0000	88.00	
16	<input type="checkbox"/>	11.955 V	0.9963 mA	13.0000	95.00	
17	<input type="checkbox"/>	12.020 V	0.9976 mA	14.0000	95.00	
18	<input type="checkbox"/>	12.275 V	1.0046 mA	15.0000	95.00	
19	<input type="checkbox"/>	11.500 V	1.0042 mA	16.0000	95.00	

**Set voltage limit**

The dialog box shows a table for setting voltage limits for 20 channels. The main interface shows the 'Voltage' column with values ranging from 1.496 V to 14.973 V.

Channel	Lock	Voltage	Current	Voltage Settings	Current Settings	Notes
1	<input type="checkbox"/>	1.496 V	0.1259 mA	1.2000	20.00	
2	<input type="checkbox"/>	2.499 V	0.2068 mA	2.2000	25.00	
3	<input type="checkbox"/>	3.301 V	0.2756 mA	3.2000	30.00	
4	<input type="checkbox"/>	3.998 V	0.3024 mA	4.0000	35.00	
5	<input type="checkbox"/>	4.499 V	0.3812 mA	4.2000	40.00	
6	<input type="checkbox"/>	5.000 V	0.4882 mA	5.0000	45.00	
7	<input type="checkbox"/>	5.503 V	0.4519 mA	5.2000	50.00	
8	<input type="checkbox"/>	6.003 V	0.5029 mA	6.0000	55.00	
9	<input type="checkbox"/>	6.997 V	0.5843 mA	7.0000	60.00	
10	<input type="checkbox"/>	7.991 V	0.6536 mA	8.0000	65.00	
11	<input type="checkbox"/>	8.494 V	0.7047 mA	8.2000	70.00	
12	<input type="checkbox"/>	8.988 V	0.7462 mA	9.0000	75.00	
13	<input type="checkbox"/>	9.994 V	0.8266 mA	10.0000	80.00	
14	<input type="checkbox"/>	10.988 V	0.9085 mA	11.0000	85.00	
15	<input type="checkbox"/>	11.959 V	0.9847 mA	12.0000	90.00	
16	<input type="checkbox"/>	12.977 V	1.0775 mA	13.0000	100.00	
17	<input type="checkbox"/>	13.986 V	1.1615 mA	14.0000	120.00	
18	<input type="checkbox"/>	14.973 V	1.2268 mA	15.0000	130.00	

**Important note:** When you input the values, always press 'Enter'.

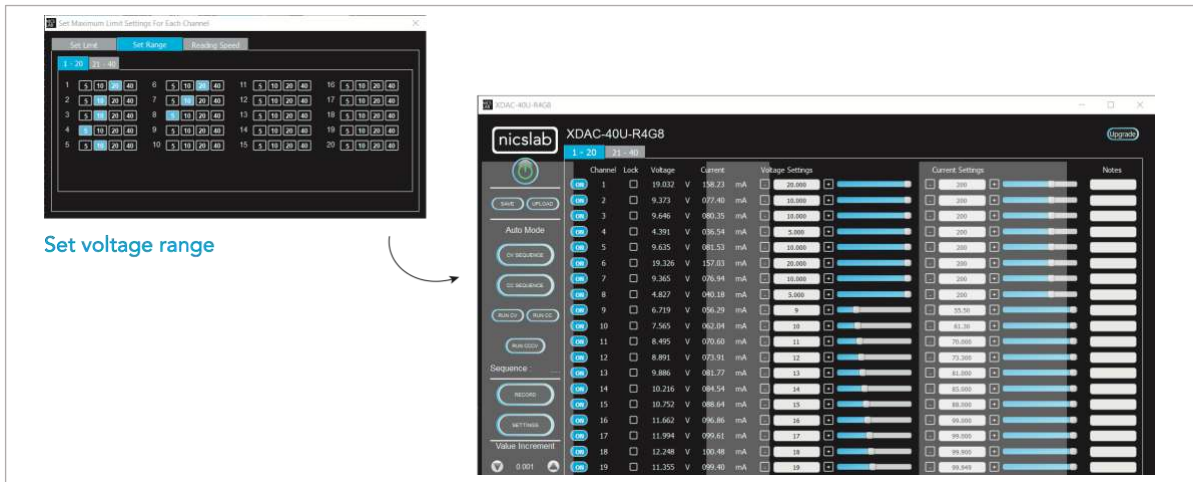

Reading Speed



## Value Increment Setting

In this setting, the value of the voltage and current can be incrementally changed from minimum 0.001 to 1. Adjust the arrow to increase and decrease the value increment (B11).

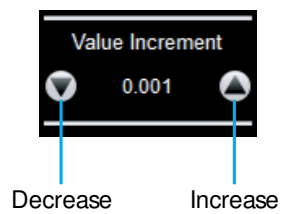

## 4. Operating XDAC through SCPI command

This section set guidelines to help you develop program for any language suits you best. As an example, we give the Python example.

### Python Installation (Example)

Please follow steps below for dynamic programming using SCPI command through Python via TCP/IP.

The following Python and packages need to be installed:

1. Python 2.7 or Python 3.X (download and install the latest version from [www.python.org](http://www.python.org)). \*Tested with Python 3.9.
2. PyCharm 2017.3.4 or the latest version (download and install the latest version from <https://www.jetbrains.com/pycharm/>)

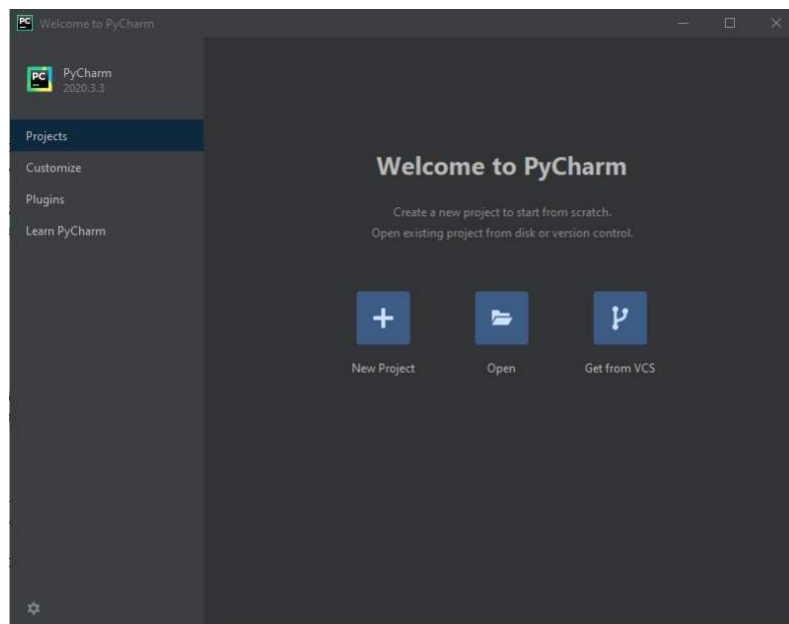

## Run Python Code (Example)

To run the Python code please follow the steps below:

1. Open PyCharm software and open file example (e.g XDAC-40U-R4G8.py)

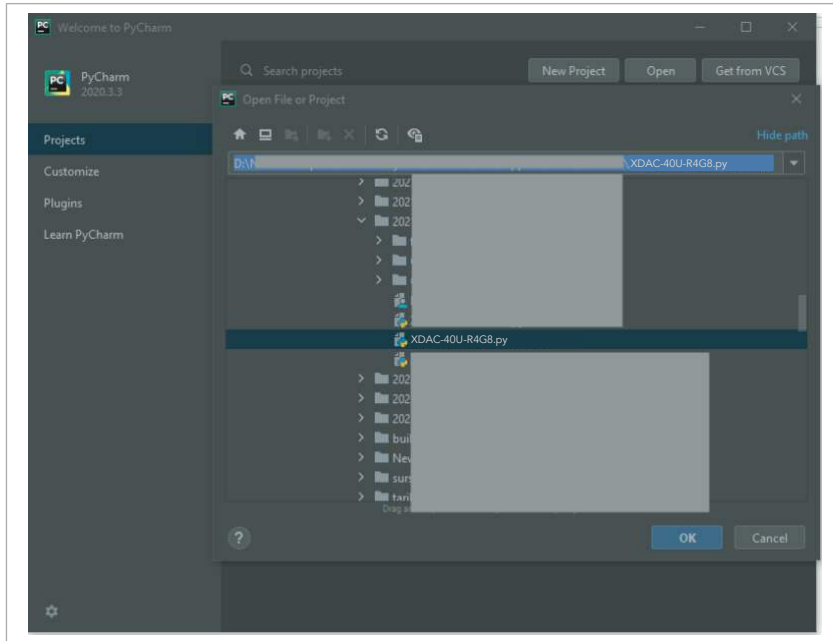

2. Configure Python interpreter (see figure below) by clicking Configure Python Interpreter link on the drop-down menu, or in File >> Settings >> Project Interpreter.

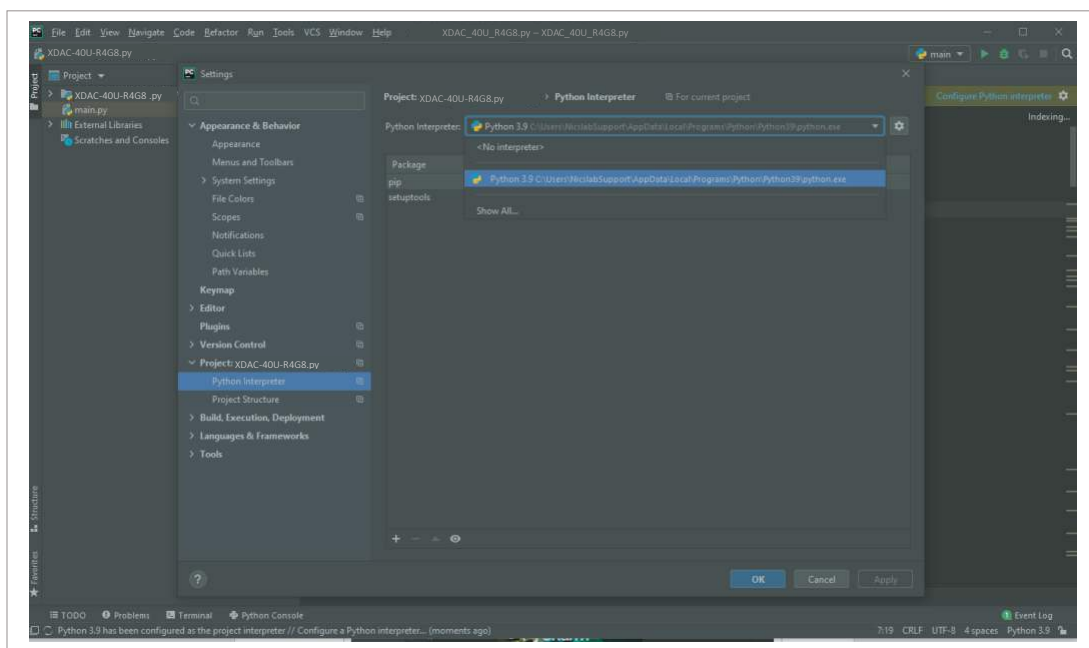

3. Install additional packages, for example: enum34, by:
  - A. clicking '+' button
  - B. search and choose enum34
  - C. install all the packages.

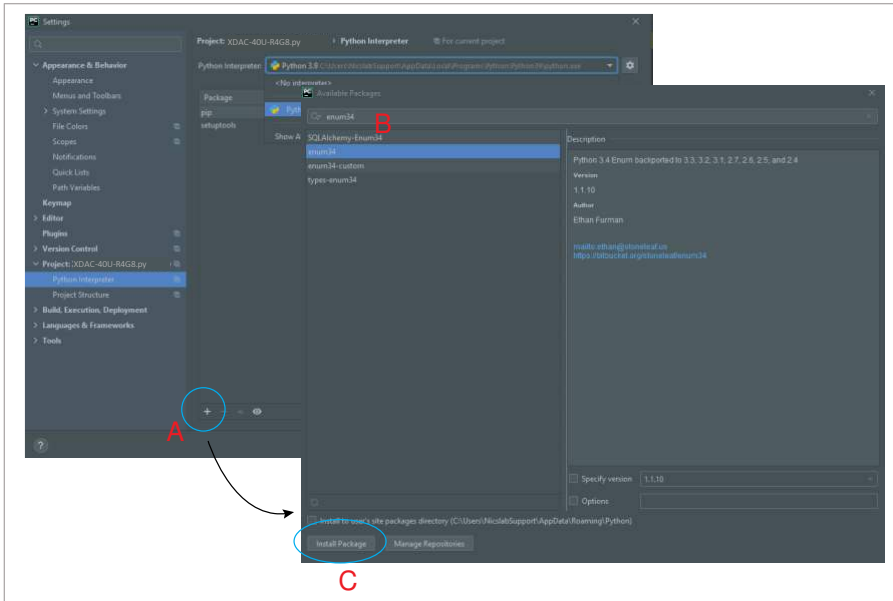

4. The packages for the Python Interpreter are listed in the green rectangle.

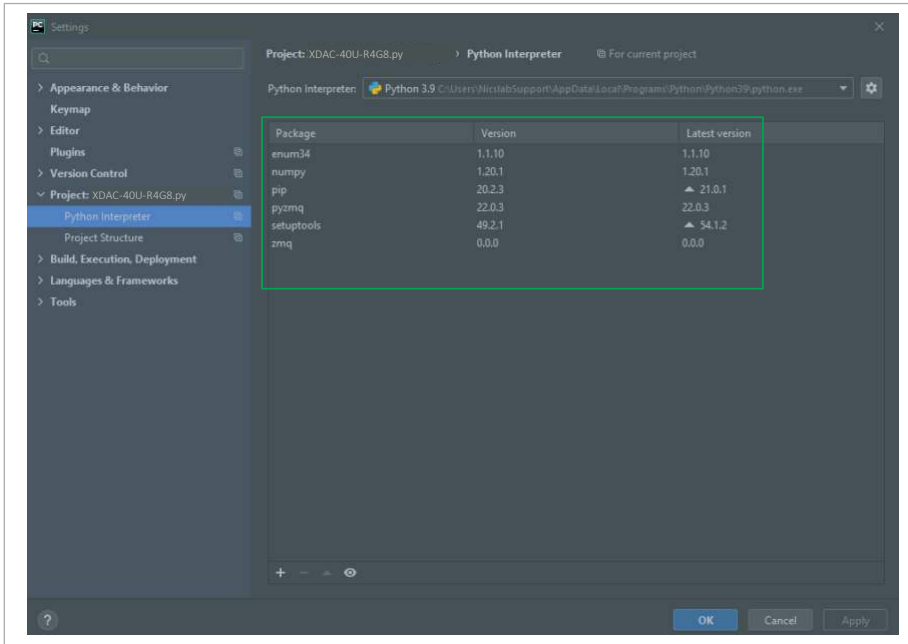

5. Select Python Configuration and choose the file name.
6. Run the file by clicking the green arrow button on the top right corner to test the XDAC (Please refer to the code and SCPI commands references).

## Python Function (Example)

### 1. Input IP Address

```
XDAC_IP = "169.xxx.xx.xx"
```

### 2. Unlock and Lock XDAC

```
unlock(XDACkey)
```

```
lock()
```

note: You must unlock your XDAC first before you can use it.

### 3. Set XDAC voltage range for all channels and measurement mode

```
setXDAC(voltRange, voltReadingMode, currentReadingMode )
```

voltRange (int list): list for all channels range

voltReadingMode (string): "FAST" or "MEDIUM" or "SLOW"

currentReadingMode (string): "FAST" or "MEDIUM" or "SLOW"

Example:

```
AllRValues = [5, 5, 6, 7, 5, 5, 7, 4]
```

```
setXDAC(AllRValues, "FAST", "SLOW")
```

### 4. Set Voltage for single channel

```
setChannelVoltage(channel, voltageVal)
```

channel (int): channel number

voltageVal (float): 0 - 36 V

Example:

```
setChannelVoltage(1, 15)
```

```
#Set voltage to 15 V in channel 1
```

### 5. Set Current for single channel

```
setChannelCurrent(channel, currentVal)
```

channel (int): channel number

currentVal (float): 0 - 300 mA

Example:

```
setChannelCurrent(1, 200)
#Set current to 200 mA in channel 1
```

#### 6. Set Voltage Range for single channel

```
setChannelVoltageRange(channel, range)
```

channel (int): channel number

rangeVal (int): 0 - 3

0 = 0 - 5 V

1 = 0 - 10 V

2 = 0 - 20 V

3 = 0 - 36 V

#### 7. Set for all channels

```
setVoltageAllChannels(AllVValues)
```

AllVValues (float array): voltage values in an array (V)

```
setCurrentAllChannels(AllCValues)
```

AllCValues (float array): current values in array (mA)

```
setRangeAllChannels(AllRValues)
```

AllRValues (float array): range values in an array

Example:

```
AllCValues = [100, 150, 100, 50, 200, 10, 10]
```

```
AllVValues = [20.1, 2.5, 13.0, 4, 5, 10.5, 9.5, 22]
```

```
AllRValues = [5, 5, 6, 7.5, 5, 7.4]
```

```
setRangeAllChannels(AllRValues)
```

```
setVoltageAllChannels(AllVValues)
```

```
setCurrentAllChannels(AllCValues)
```

8. Set OFF for single channel

```
setOff(channel)
```

channel (int): channel number

9. Read single-channel value

```
readSingleChannelVoltage(channel)
```

```
readSingleChannelCurrent(channel)
```

channel (int): channel number

return value of voltage or current in one channel

10. Read real-time value for all channels

```
readAllChannelVoltage()
```

Return list of voltage from all channels

```
readAllChannelCurrent()
```

Return list of current from all channels

11. Set one channel to run automatically and record it

```
sweepOne(channel, seqValueV, seqValueC, duration)
```

channel (int): channel number

seqValueV: voltage values in an array (V)

seqValueC: current values in an array (mA)

duration (int): duration in seconds

12. Measurement Configuration

```
measurementConfig(averagingSample, voltageConv, currentConv)
```

Set measurement averaging sample, voltage, and current conversion time

averagingSample (int): Measurement sample to be averaged

voltageConv (int  $\mu$ S) = voltage conversion time in  $\mu$ s

currentConv (int  $\mu$ S) = current conversion time in  $\mu$ s



### 13. Sweep value for single channel

```
sweepOne(channel, seqValueV, seqValueC, duration)
```

```
channel (int): channel number
```

```
seqValueV (list): list of voltage value
```

```
seqValueC (list): list of current value
```

```
duration (int): duration in seconds
```

### 14. Shutdown XDAC

```
shutdown()
```

## SCPI Commands

The XDAC can be controlled using Standard Commands for Programmable Instruments (SCPI).

### Description: Unlock XDAC by XDAC Key

Format:

```
GETINFO:KEY
```

Example 1: Unlock XDAC with XDAC Key : nicslabtes.

```
GETINFO:nicslabtes
```

### Description: Lock XDAC

Format:

```
LOCK
```

### Description: Set output voltage for single channel

Format:

```
SETV:CHANNEL:VOLT
```

Example 1: Set the output of channel 1 to 4 V.

```
SETV:1:4
```

Example 2: Set the output of channel 3 to 0.25 V.

```
SETV:3:0.25
```

Description: Set output current for single channel

Format:

SETC:CHANNEL:CURRENT

Example 1: Set the output of channel 1 to 100 mA.

SETC:1:100

Example 2: Set the output of channel 3 to 50 mA.

SETC:3:50

Description: Set output voltage range for single channel

Format:

SETR:CHANNEL:RANGE

range(int): 0 - 3

0 = 0 – 5 V

1 = 0 – 10V

2 = 0 – 20 V

3 = 0 – 36 V

Example 1: Set the output range of channel 1 to 0 – 36 V.

SETR:1:3

Description: Read voltage of a single channel

Format:

MEASV:CHANNEL

Example 1: Get the voltage output of channel 1.

MEASV:1

Description: Read current of a single channel

Format:

MEASC:CHANNEL

Example 1: Get the current output of channel 3.

MEASC:3

Description: Change Measurement config for All Channels

Format:

CONFIG:AVERAGINGSAMPLE:VOLTAGECONV:CURRENTCONV

Example: Set measurement configuration to 16 samples, 588  $\mu$ s voltage conversion time, and 588  $\mu$ s current conversion time.

CONFIG:16:588:588

Description: Set zero voltage for a single channel

Format:

ZERO:CHANNEL

example: Set zero of channel 1

ZERO:1

Description: Shutdown System

Format:

EXIT

## 5. System Shutdown

This section describes how to shut down the XDAC-40U-R4G8.

In the case of using GUI, the steps are as follows:

1. Set OFF all the channel in the GUI.
2. Press the ON/OFF Button in GUI (B1, Figure 4), this will change the color of the button from green to grey.
3. Close The GUI window (this will soft shutdown the program inside the XDAC-40U-R4G8).
4. Press the button A1 (Figure 3).
5. Turn off or disconnect the power from the DC Power Supply.

In the case of using SCPI or Python, the steps are as follows:

1. Use `setOff(channel)` function to set off the channel used before.
2. Use `lock()` and `shutdown()` function to soft shutdown the program inside the XDAC-40U-R4G8.
3. Press the button A1 (Figure 3).
4. Turn off or disconnect the DC Power Supply.

**NOTE :** once the soft shutdown occurred, the **Green & Blue** led will be turned off, and XDAC-40U-R4G8 cannot directly be used again, since the system is not ready (refers to Hardware Installation,). To use XDAC-40U-R4G8 after a soft shutdown occurred, restart the power from DC Power Supply (using button A1 or unplug and plug the DC Power Supply).

## 6. Troubleshooting

Please use the following guidelines to identify problem. If the solution does not rectify the problem, contact us at [support@nicslab.com](mailto:support@nicslab.com).

Table 5. Troubleshooting

Problem	Cause	Solution
Failed to connect at GUI	The DC power supply is OFF	Turn ON the DC power supply and switch ON the power
Failed to connect at GUI	The switch power is OFF	Switch ON the power
Failed to connect at GUI	No Green light (no data transfer)	Restart the GUI
The Green light offs when software active or software freeze	Initialization failed	Restart the software / unplug - plug USB/Ethernet connector/Press Reset Button
No channel output detected at device under test	Connection failed	Check metal pad check point to intended channel
Unable to upload the file	File format problem	Make sure the file format is .csv
No value after upload the file	File problem	Check the file content, make sure there is no blank space on each row.
Unable to use Auto Mode feature	File format problem	Check file format should be csv file. Check content format

## 7. Warranty

Nicslab warrants the hardware and software designed by Nicslab to work accordingly fulfilling the highest standard of quality product. Nicslab is not liable for consequential or incidental damages or for errors in subject to misuse, neglect, accident, modification, or has been soldered or altered in any way outside stated by us or unauthorized maintenance.

Nicslab retains to change the material and technical data of this manual at any time without notice, in future editions.

Please do not hesitate to contact us at [support@nicslab.com](mailto:support@nicslab.com) if you would like to have more information on warranty or return and refund policy.

## 8. Compliance

This product complies to the requirements of the European Union's *Conformite Europeenne* (CE) and Restriction of Hazardous Substances in Electrical and Electronic Equipment (RoHS) Directive 2015/863 (RoHS3). The certificates can be accessed [here](#).

## 9. Contact

### United States

Nicslab Ops, Inc.

228 Hamilton Avenue, 3<sup>rd</sup> Floor, Palo Alto

Silicon Valley, CA, 94301

Phone number: +1 (650) 798-5000

WhatsApp: +1 (650) 613-2494

Email: [support@nicslab.com](mailto:support@nicslab.com)

Website: [www.nicslab.com](http://www.nicslab.com).

### Indonesia

PT. Nicslab Global Industri

Wisma Monex 9<sup>th</sup> floor

Jl. Asia Afrika No. 133-132, Bandung West Java 40112

Phone: +62 22 8602 6854

Email: [nicslab.id@nicslab.com](mailto:nicslab.id@nicslab.com).

Book Meeting [here](#).