



IR Emitter and Detector Product Data Sheet

LTE-4206C

Spec No.: DS-50-92-0027

Effective Date: 05/10/2000

Revision: B

LITE-ON DCC

RELEASE

BNS-OD-FC001/A4

FEATURES

- * SELECTED TO SPECIFIC ON-LINE INTENSITY AND RADIANT INTENSITY RANGES
- * LOW COST MINIATURE PLASTIC END LOOKING PACKAGE
- * MECHANICALLY AND SPECTRALLY MATCHED TO THE LTR-4206 SERIES OF PHOTOTRANSISTOR
- * SMOKING TRANSPARENT COLOR PACKAGE

PACKAGE DIMENSIONS

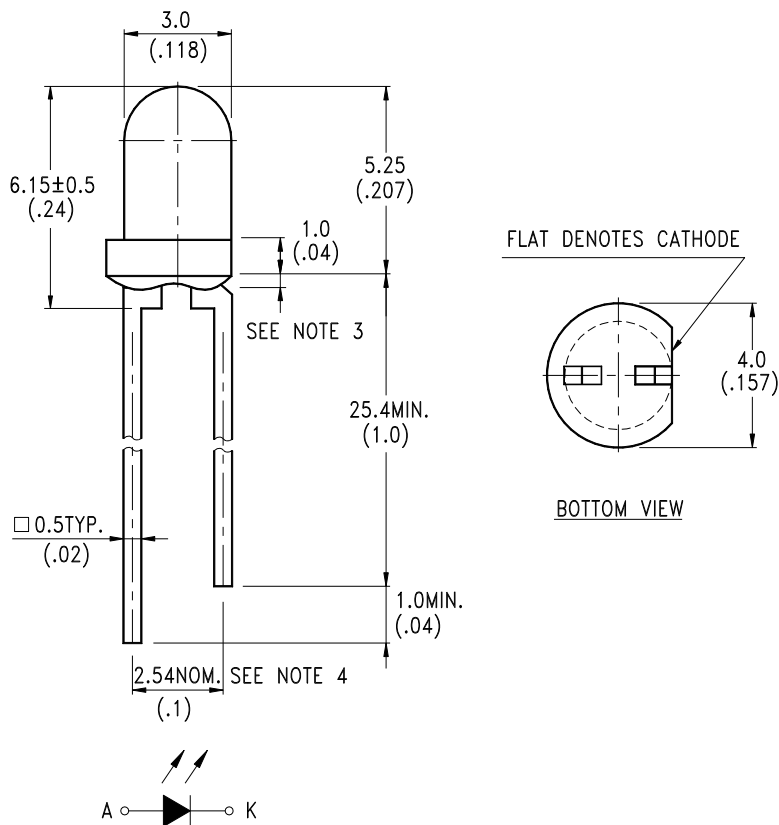

NOTES:

1. All dimensions are in millimeters (inches).
2. Tolerance is ±0.25mm(.010") unless otherwise noted.
3. Protruded resin under flange is 1.0mm(.039") max.
4. Lead spacing is measured where the leads emerge from the package.
5. Specifications are subject to change without notice.



LITE-ON ELECTRONICS, INC.

Property of Lite-On Only

ABSOLUTE MAXIMUM RATINGS AT TA=25°C

PARAMETER	MAXIMUM RATING	UNIT
Power Dissipation	90	mW
Peak Forward Current (300pps, 10 μ s pulse)	1	A
Continuous Forward Current	60	mA
Reverse Voltage	5	V
Operating Temperature Range	-40°C to + 85°C	
Storage Temperature Range	-55°C to + 100°C	
Lead Soldering Temperature [1.6mm(.063") From Body]	260°C for 5 Seconds	

ELECTRICAL OPTICAL CHARACTERISTICS AT TA=25°C

PARAMETER	SYMBOL	MIN.	TYP.	MAX.	UNIT	TEST CONDITION	BIN NO.
Aperture Radiant Incidence	E _e	0.184		0.54	mW/cm ²	I _F = 20mA	BIN A
		0.36		0.78			BIN B
		0.52		1.02			BIN C
		0.68					BIN D
Radiant Intensity	I _E	1.383		4.06	mW/sr	I _F = 20mA	BIN A
		2.71		5.87			BIN B
		3.91		7.67			BIN C
		5.11					BIN D
Peak Emission Wavelength	λ_{Peak}		940		nm	I _F = 20mA	
Spectral Line Half-Width	$\Delta \lambda$		50		nm	I _F = 20mA	
Forward Voltage	V _F		1.2	1.6	V	I _F = 20mA	
Reverse Current	I _R			100	μ A	V _R = 5V	
Viewing Angle (See FIG.6)	$2\theta_{1/2}$		20		deg.		

TYPICAL ELECTRICAL / OPTICAL CHARACTERISTICS CURVES

(25°C Ambient Temperature Unless Otherwise Noted)

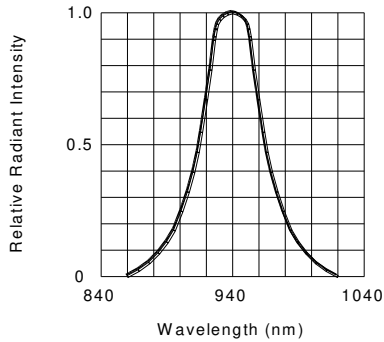

FIG.1 SPECTRAL DISTRIBUTION

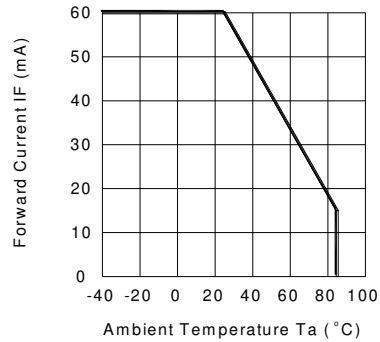

FIG.2 FORWARD CURRENT VS. AMBIENT TEMPERATURE

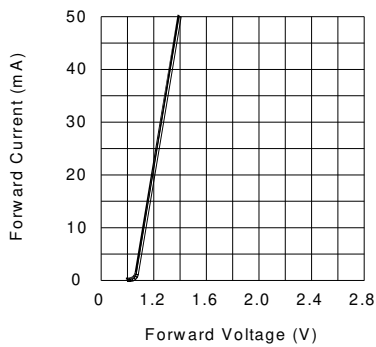

FIG.3 FORWARD CURRENT VS. FORWARD VOLTAGE

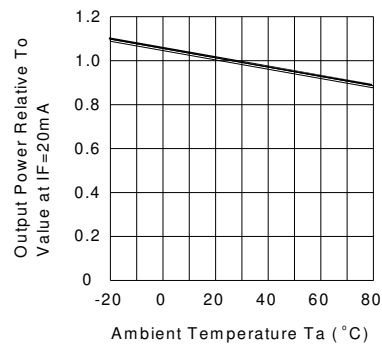

FIG.4 RELATIVE RADIANT INTENSITY VS. AMBIENT TEMPERATURE

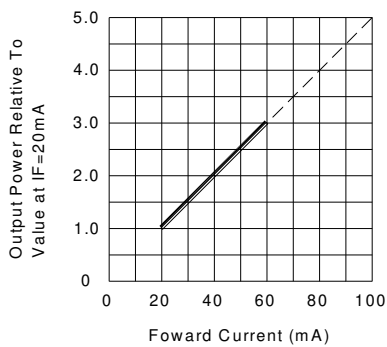

FIG.5 RELATIVE RADIANT INTENSITY VS. FORWARD CURRENT

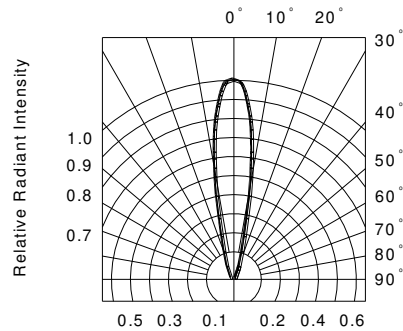

FIG.6 RADIATION DIAGRAM