

FEATURES

- **Low Supply Current** 230 μ A Max
- **Wide Supply Range** $\pm 2.5V$ to $\pm 15V$
- **Low Input Offset Voltage** 100 μ V Max
- **Low Input Offset Voltage Drift** 1.0 μ V/ $^{\circ}$ C Max
- **High Common-Mode Input Range** $V^- (+0.5V)$ to $V^+ (-1.5V)$
- **High CMRR and PSRR** 100dB Min
- **High Open-Loop Gain** 1000V/mV Min
- **125 $^{\circ}$ C Temperature Tested Dice**

ORDERING INFORMATION [†]

$T_a = +25^{\circ}\text{C}$ V_{OS} MAX (μV)	PACKAGE			OPERATING TEMPERATURE RANGE
	TO-99	CERDIP 8-PIN	PLASTIC 8-PIN	
100	OP21AJ	OP21AZ*	—	MIL
100	—	OP21EZ	—	IND
200	OP21FJ	OP21FZ	OP21FP	IND
500	OP21GJ	—	OP21GP	XIND
500	—	—	OP21HS ^{††}	XIND

* For devices processed in total compliance to MIL-STD-883, add /883 after part number. Consult factory for 883 data sheet.

[†] Burn-in is available on commercial and industrial temperature range parts in CerDIP, plastic DIP, and TO-can packages.

^{††} For availability and burn-in information on SO and PLCC packages, contact your local sales office.

GENERAL DESCRIPTION

The OP-21 is a precision low-power operational amplifier offering the benefits of low offset voltage and high slew rate with the advantages of low power. A supply range of $\pm 2.5V$ to $\pm 15V$ allows a wide range of applications.

Two military temperature range models and three industrial temperature range models are available in TO-99 cans and 8-Pin hermetic DIPs. Industrial temperature range models are also available in 8-Pin epoxy DIPs. See OP-221 for dual and OP-421 for quad versions of the OP-21.

PIN CONNECTIONS

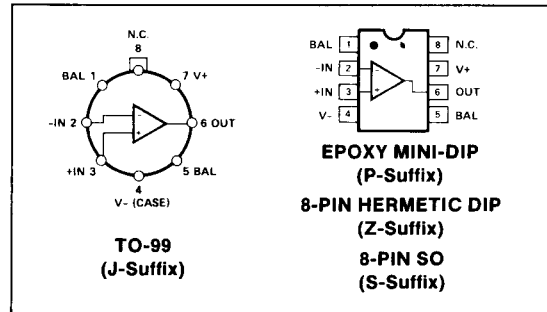

SIMPLIFIED SCHEMATIC

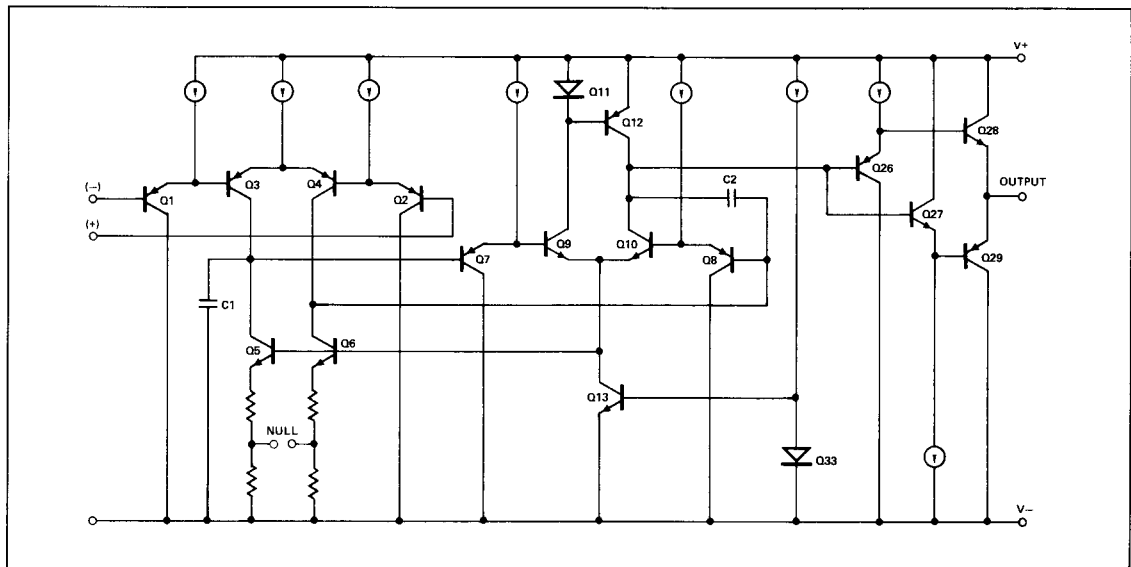

OP-21

ABSOLUTE MAXIMUM RATINGS (Note 2)

Supply Voltage	±18V
Differential Input Voltage	±30V
Input Voltage	Supply Voltage
Output Short-Circuit Duration	Indefinite
Storage Temperature Range	
J and Z Packages	-65°C to +125°C
P Package	-65°C to +125°C
Operating Temperature Range	
OP-21A	-55°C to +125°C
OP-21E, OP-21F	-25°C to +85°C
OP-21HS, OP-21G	-40°C to +85°C

Junction Temperature (T _J)	-65°C to +150°C
Lead Temperature (Soldering, 60 sec)	300°C

PACKAGE TYPE	θ _{JA} (Note 1)	θ _{JC}	UNITS
TO-99 (J)	150	18	°C/W
8-Pin Hermetic DIP (Z)	148	16	°C/W
8-Pin Plastic DIP (P)	103	43	°C/W
8-Pin SO (S)	158	43	°C/W

NOTES:

1. θ_{JA} is specified for worst case mounting conditions, i.e., θ_{JA} is specified for device in socket for TO, CerDIP, P-DIP, and LCC packages; θ_{JA} is specified for device soldered to printed circuit board for SO package.
2. Absolute maximum ratings apply to both DICE and packaged parts, unless otherwise noted.

ELECTRICAL CHARACTERISTICS at V_S = ±2.5V to ±15V and T_A = +25°C, unless otherwise noted.

PARAMETER	SYMBOL	CONDITIONS	OP-21A/E			OP-21F			OP-21G/H			UNITS
			MIN	TYP	MAX	MIN	TYP	MAX	MIN	TYP	MAX	
Input Offset Voltage	V _{OS}	V _S = ±15V	—	40	100	—	150	200	—	300	500	μV
Input Offset Current	I _{OS}	V _{CM} = 0	—	0.6	4	—	0.8	5	—	1.2	6	nA
Input Bias Current	I _B	V _{CM} = 0	—	50	100	—	60	120	—	70	150	nA
Input Voltage Range	IVR	V _S = ±15V	-14.5/13.5	—	—	-14.5/13.5	—	—	-14.5/13.5	—	—	V
Common-Mode Rejection Ratio	CMRR	V _S = ±15V, No Load -14.5V ≤ V _{CM} ≤ 13.5V	100	110	—	90	105	—	84	100	—	dB
Power Supply Rejection Ratio	PSRR	V _S = ±2.5V to ±15V, No Load	—	2	6	—	4	10	—	10	32	μV/V
Large-Signal Voltage Gain	A _{VO}	V _S = ±15V, R _L = 10kΩ, V _O ±10V	1000	2000	—	500	1500	—	500	1000	—	V/mV
Output Voltage Swing	V _O	V _S = ±15V, R _L = 10kΩ	-13.7/14.0	—	—	-13.7/13.9	—	—	-13.6/13.8	—	—	V
Slew Rate	SR	C _L = 100pF, R _L = 25kΩ	—	0.25	—	—	0.25	—	—	0.25	—	V/μs
Closed-Loop Bandwidth	BW	A _{VCL} = +1, R _L = 10kΩ	—	600	—	—	600	—	—	600	—	kHz
Supply Current	I _{SY}	V _S = ±2.5V, No Load	—	170	230	—	180	275	—	190	300	μA
		V _S = ±15V, No Load	—	230	300	—	235	360	—	250	420	

ELECTRICAL CHARACTERISTICS at $V_S = \pm 2.5V$ to $\pm 15V$, $-55^\circ C \leq T_A \leq +125^\circ C$ for OP-21A, $-25^\circ C \leq T_A \leq +85^\circ C$ for OP-21E and OP-21F, $-40^\circ C \leq T_A \leq +85^\circ C$ for OP-21G and OP-21H, unless otherwise noted.

PARAMETER	SYMBOL	CONDITIONS	OP-21A/E			OP-21F			OP-21G/H			UNITS
			MIN	TYP	MAX	MIN	TYP	MAX	MIN	TYP	MAX	
Average Input Offset Voltage Drift (Notes 1, 2)	TCV_{OS}	Unnulled	—	0.5	1.0	—	1.0	2.0	—	2.5	5.0	$\mu V/^\circ C$
	TCV_{OSn}	Nulled	—	—	—	—	—	—	—	—	—	—
Input Offset Voltage	V_{OS}		—	75	200	—	200	500	—	500	1000	μV
Input Offset Current	I_{OS}	$V_{CM} = 0$	—	0.7	5	—	0.7	6	—	0.8	8	nA
Input Bias Current	I_B	$V_{CM} = 0$	—	50	110	—	60	130	—	70	165	nA
Input Voltage Range	IVR		-14.3/13.2	—	—	-14.3/13.2	—	—	-14.3/13.2	—	—	V
Common-Mode Rejection Ratio	CMRR	No Load, $V_S = \pm 15V$, $-14.5V \leq V_{CM} \leq 13.2V$	96	105	—	86	100	—	80	95	—	dB
Power Supply Rejection Ratio	PSRR	$V_S = \pm 2.5V$ to $\pm 15V$, No Load	—	4	10	—	6	18	—	18	57	$\mu V/V$
Large-Signal Voltage Gain	A_{VO}	$V_S = \pm 15V$, $R_L = 20k\Omega$, $V_O = \pm 10V$	500	1500	—	250	1300	—	250	1000	—	V/mV
Output Voltage Swing	V_O	$V_S = \pm 15V$, $R_L = 20k\Omega$	-13.5/13.8	—	—	-13.5/13.7	—	—	-13.5/13.6	—	—	V
Supply Current	I_{SY}	$V_S = \pm 2.5V$, No Load	—	205	275	—	215	330	—	230	360	μA
		$V_S = \pm 15V$, No Load	—	275	360	—	285	430	—	300	500	

NOTES:

1. Sample tested.
2. TCV_{OSn} is guaranteed by unnulled TCV_{OS} and device design.

2

OP-21

DICE CHARACTERISTICS (125°C TESTED DICE AVAILABLE)

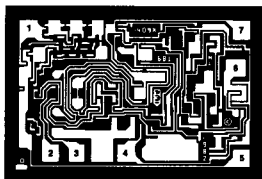

DIE SIZE 0.069 × 0.046 inch, 3174 sq. mils
(1.75 × 1.17 mm, 2.05 sq. mm)

1. BALANCE
2. INVERTING INPUT
3. NONINVERTING INPUT
4. V⁻
5. BALANCE
6. OUTPUT
7. V⁺

ELECTRICAL CHARACTERISTICS at $V_S = \pm 15V$, $T_A = +25^\circ C$ for OP-21N and OP-21G devices; $T_A = +125^\circ C$ for OP-21NT and OP-21GT devices, unless otherwise noted.

PARAMETER	SYMBOL	CONDITIONS	OP-21NT LIMIT	OP-21N LIMIT	OP-21GT LIMIT	OP-21G LIMIT	UNITS
Input Offset Voltage	V_{OS}		200	100	500	200	μV MAX
Input Offset Current	I_{OS}	$V_{CM} = 0$	4	4	5	5	nA MAX
Input Bias Current	I_B	$V_{CM} = 0$	100	100	120	120	nA MAX
Input Voltage Range	IVR		-14.3 +13.5	-14.5 +13.5	-14.3 +13.5	-14.5 +13.5	V MIN
Common-Mode Rejection Ratio	CMRR	No Load CMVR = IVR	96	100	86	90	dB MIN
Power Supply Rejection Ratio	PSRR	$V_S = \pm 2.5V$ to $\pm 15V$ No Load	10	6	18	10	$\mu V/V$ MAX
Large-Signal Voltage Gain	A_{VO}	$R_L = 10k\Omega$, $V_O = \pm 10V$	500	1000	250	500	V/mV MIN
Output Voltage Swing	V_O	$R_L = 10k\Omega$	-13.5 +13.8	-13.7 +14.0	-13.5 +13.8	-13.7 +13.9	V MIN
Supply Current	I_{SY}	No Load	300	300	360	360	μA MAX

NOTES:

For 25°C characteristics of NT & GT devices, see N & G characteristics respectively.

Electrical tests are performed at wafer probe to the limits shown. Due to variations in assembly methods and normal yield loss, yield after packaging is not guaranteed for standard product dice. Consult factory to negotiate specifications based on dice lot qualification through sample lot assembly and testing.

TYPICAL ELECTRICAL CHARACTERISTICS at $V_S = \pm 15V$, $T_A = +25^\circ C$, unless otherwise noted.

PARAMETER	SYMBOL	CONDITIONS	OP-21NT TYPICAL	OP-21N TYPICAL	OP-21GT TYPICAL	OP-21G TYPICAL	UNITS
Average Input Offset Voltage Drift	TCV_{OS}	Unnulled	0.5	0.5	1	1	$\mu V/^\circ C$
Nullled Input Offset Voltage Drift	TCV_{OSn}	Nullled, $R_p = 10k\Omega$	0.5	0.5	1	1	$\mu V/^\circ C$
Large-Signal Voltage Gain	A_{VO}	$R_L = 10k\Omega$	2000	2000	1500	1500	V/mV
Slew Rate	SR	$R_L = 25k\Omega$ $C_L = 100pF$	0.25	0.25	0.25	0.25	V/ μs
Closed-Loop Bandwidth	BW	$A_{VCL} = +1$ $R_L = 10k\Omega$	600	600	600	600	kHz

TYPICAL PERFORMANCE CHARACTERISTICS

2

OPEN-LOOP GAIN vs TEMPERATURE

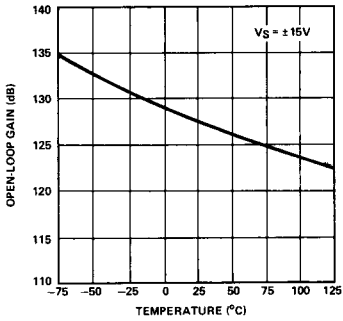

SUPPLY CURRENT vs TEMPERATURE

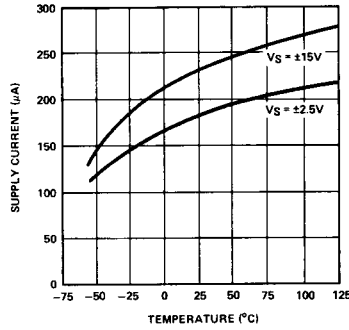

OFFSET CURRENT vs TEMPERATURE

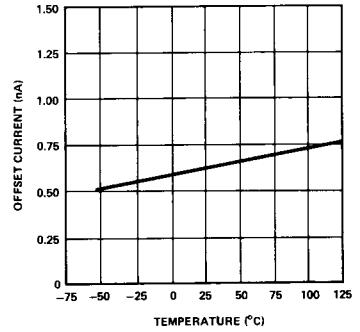

BIAS CURRENT vs TEMPERATURE

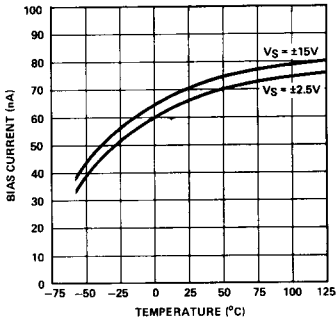

OPEN-LOOP GAIN vs FREQUENCY

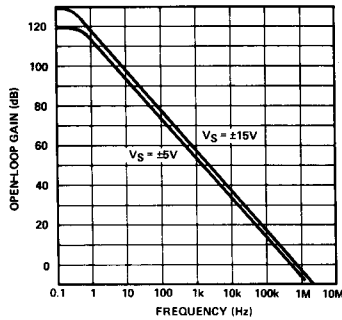

CLOSED-LOOP GAIN vs FREQUENCY

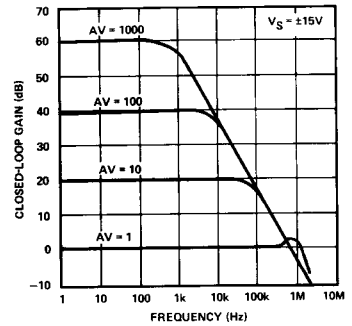

CMRR vs FREQUENCY

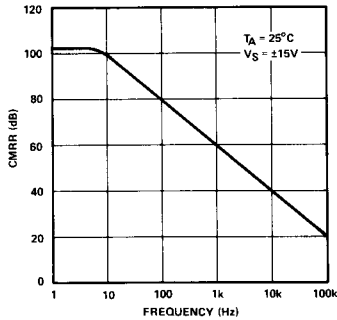

MAXIMUM OUTPUT SWING vs FREQUENCY

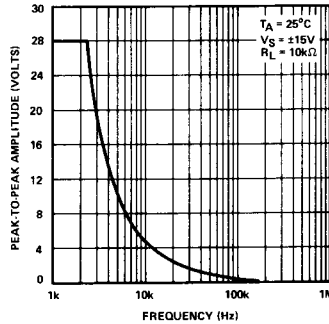

TYPICAL PERFORMANCE CHARACTERISTICS

VOLTAGE NOISE DENSITY vs FREQUENCY

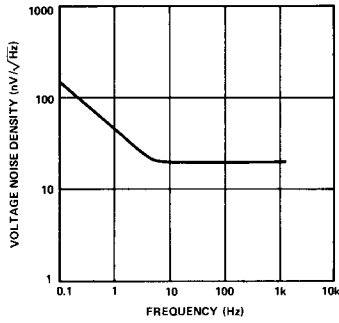

CURRENT NOISE DENSITY vs FREQUENCY

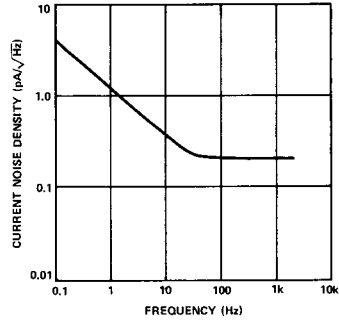

NONINVERTING LARGE-SIGNAL RESPONSE

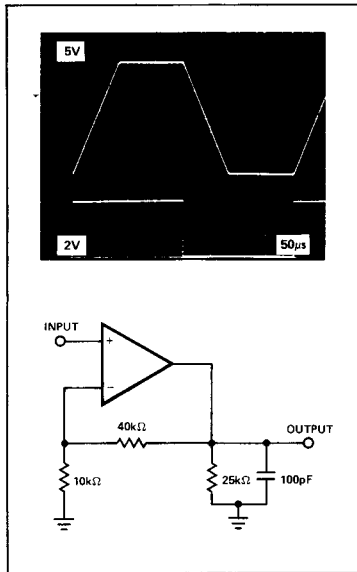

NONINVERTING SMALL-SIGNAL RESPONSE

