

GENERAL DESCRIPTION

The 1030/1090MHz, 50V or 52V 1011GN-1600VG is an internally matched, common source, class AB, GaN on SiC HEMT transistor capable of providing greater than 1600 Watts of pulsed output power with over 18.5 dB gain and greater than 70% drain efficiency under pulse formats that include 32us pulse width, 2% duty cycle; Mode-S ELM; and IFF. The transistor is internally pre-matched for optimal performance and utilizes gold metallization and eutectic attach to provide highest reliability and superior ruggedness. Best Size, Weight, and Power (SWaP) output stage designs can be achieved by taking advantage of the small footprint single-ended industry standard Gemini packaged device with single gate and drain bias feeds.

CASE OUTLINE 55-Q11A Common Source

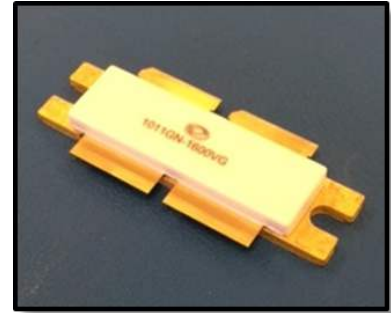

0.400"x1.610"

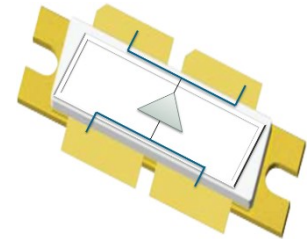

Single-Ended

ABSOLUTE MAXIMUM RATINGS

Maximum Power Dissipation

Device Dissipation @ 25°C 2850W

Maximum Voltage and Current

Drain-Source Voltage (V_{DSS}) 150 V
Gate-Source Voltage (V_{GS}) -8 to +0 V

Maximum Temperatures

Storage Temperature (T_{STG}) -55 to +125° C
Operating Junction Temperature +200° C

ELECTRICAL CHARACTERISTICS @ 25°C, 50V, 32μs Pulse Width, 2% Duty Cycle

Symbol	Characteristics	Test Conditions	Min	Typ	Max	Units
P_{IN}	Input Power	$P_{IN} = 22.4W$, Freq=1030MHz	1600	1652		W
G_P	Power Gain	$P_{IN} = 22.4W$, Freq=1030MHz	18.5	18.7		dB
η_D	Drain Efficiency	$P_{IN} = 22.4W$, Freq=1030MHz	65	74		%
Dr	Droop	$P_{IN} = 22.4W$, Freq=1030MHz			0.3	dB
VSWR-T	Load Mismatch Tolerance	$P_o = 1600W$, Freq=1030MHz			3:1	
Θ_{JC}	Thermal Resistance	32μs, 2% duty cycle			0.12	°C/W

- Bias Condition: $V_{dd} = +50V$, $I_{dq} = 200mA$ average current ($V_{gs} = -2.0 \sim -4.5V$ typical)

FUNCTIONAL CHARACTERISTICS @ 25°C

$I_{D(OFF)}$	Drain leakage current	$V_{GS} = -8V$, $V_D = 150V$			128	mA
$I_{G(OFF)}$	Gate leakage current	$V_{GS} = -8V$, $V_D = 0V$			40	mA



1011GN-1600VG

1600 Watts • 50/52 Volts • 32us, 2%
L-Band Avionics 1030/1090 MHz

Export Classification: EAR 99

TYPICAL BROAD BAND PERFORMANCE DATA

32μs Pulse Width, 2% Duty Cycle Pulsing • Idq = 200mA

Freq (Mhz)	V _{DD} (V)	P _{IN} (dBm)	P _{IN} (W)	P _{OUT} (dBm)	P _{OUT} (W)	G _p (dB)	IRL (dB)	I _d (A)	Eff (%)	Droop (dB)
1030	50	43.5	22.4	62.20	1652	18.68	-12.5	0.95	74%	0.15
1030	52	43.5	22.4	62.50	1757	18.95	-12.5	0.97	75%	0.15

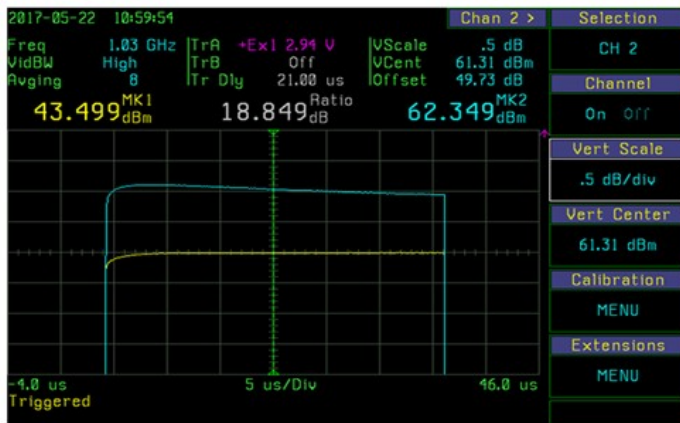
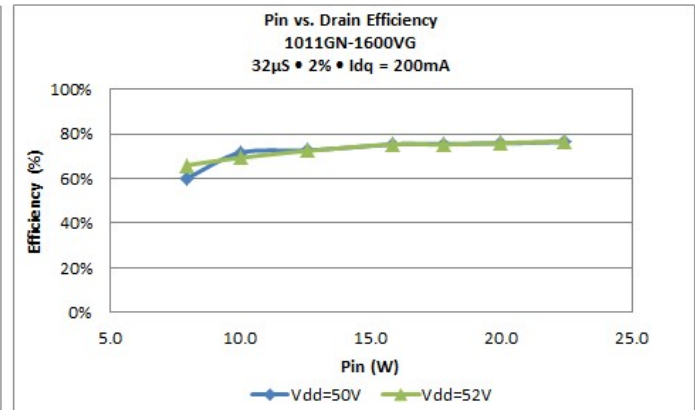
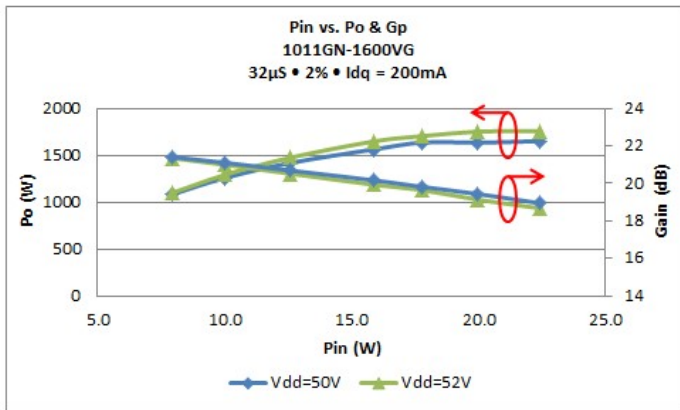

Sample Capture Waveform at 1030MHz

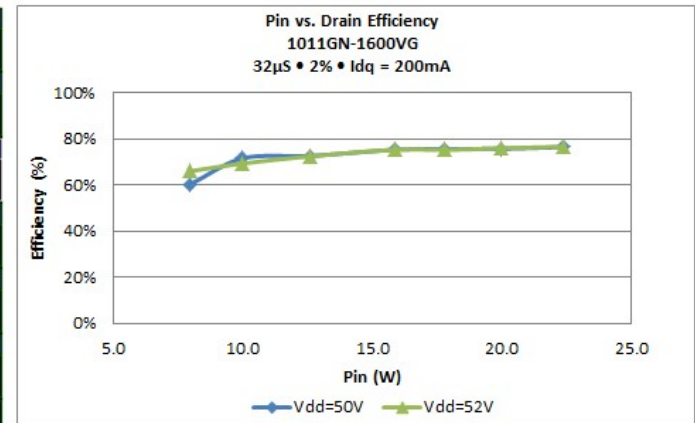



1011GN-1600VG

1600 Watts • 50/52 Volts • 32 μ s, 2%
L-Band Avionics 1030/1090 MHz

Mode-S ELM Pulsing: 32 μ s ON/18 μ s x N=48 pulses, Long Term Duty Cycle 6.4%

Freq (Mhz)	V _{DD} (V)	P _{IN} (dBm)	P _{IN} (W)	Pulse 1								Pulse 48		Droop (dB)
				P _{OUT} (dBm)	P _{OUT} (W)	G _P (dB)	IRL (dB)	G _{P-max} (dB)	I _D (A)	Eff (%)	G _P (dB)	P _{OUT} (dBm)	P _{OUT} (W)	
1030	50	43.5	22.4	18.68	1698	18.80	-12	21.5	2.92	74	18.2	61.7	1466	0.60
1030	52	43.5	22.4	18.95	1756	18.95	-12	21.6	2.93	75	18.3	61.9	1535	0.65

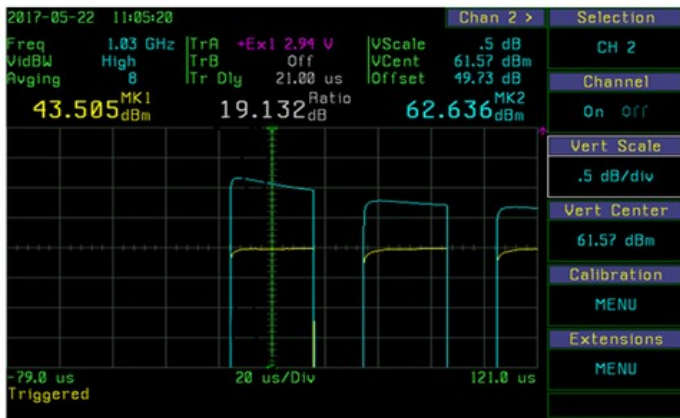
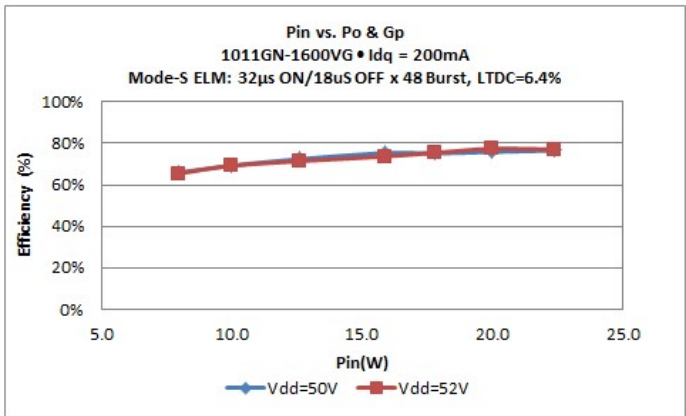
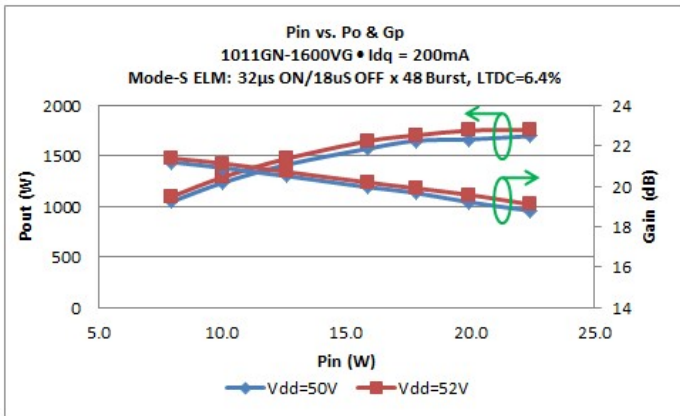

Sample Capture Waveform Mode S-ELM @Pulse 1

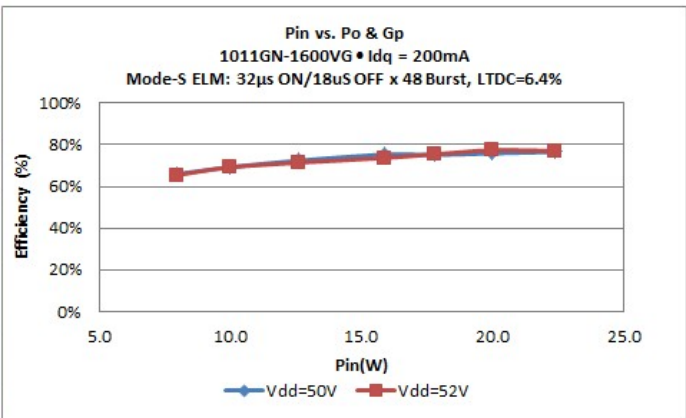



1011GN-1600VG

1600 Watts • 50/52 Volts • 32us, 2%
L-Band Avionics 1030/1090 MHz

TYPICAL OVER TEMPERATURE PERFORMANCE 50V, 32μs, 2% PULSING Top & Bottom, Standard Temperature Map & Hot Spot Transient

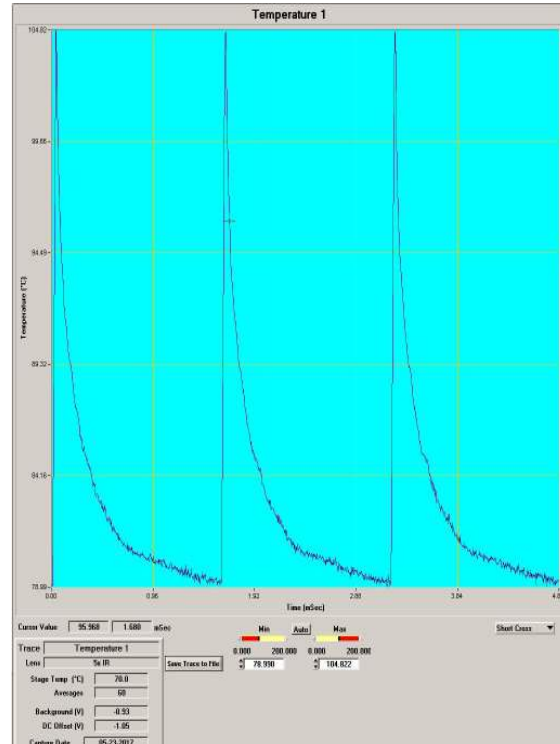
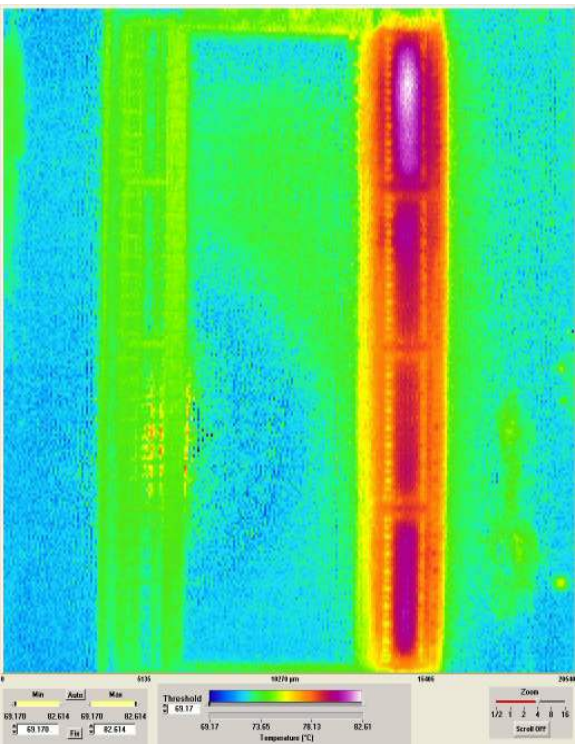
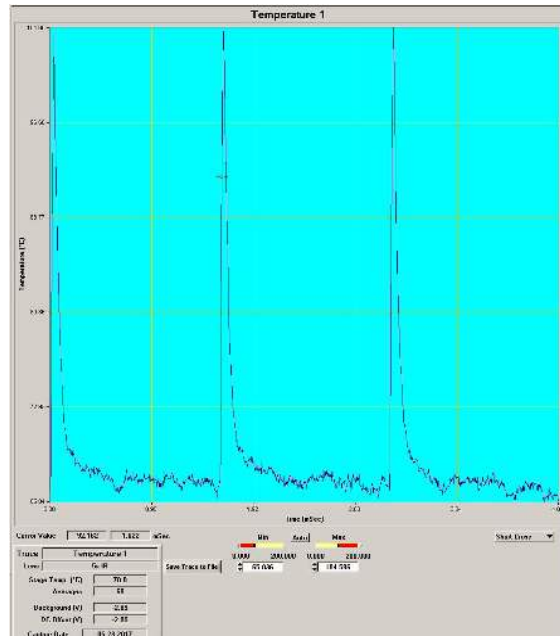
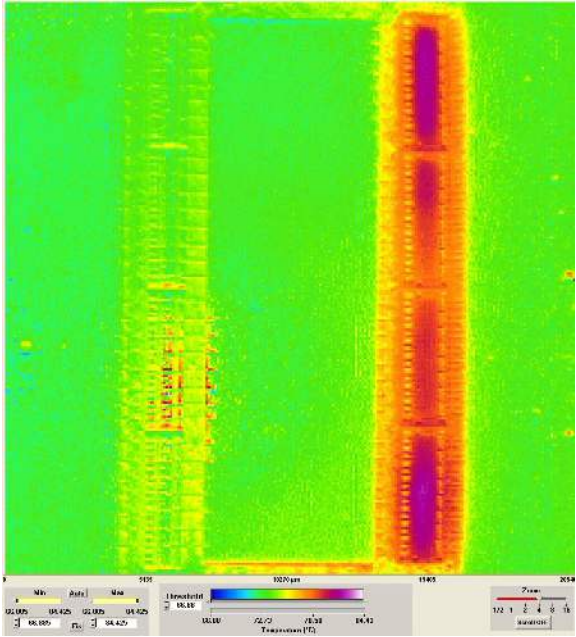

TRANSISTOR IMPEDANCE INFORMATION

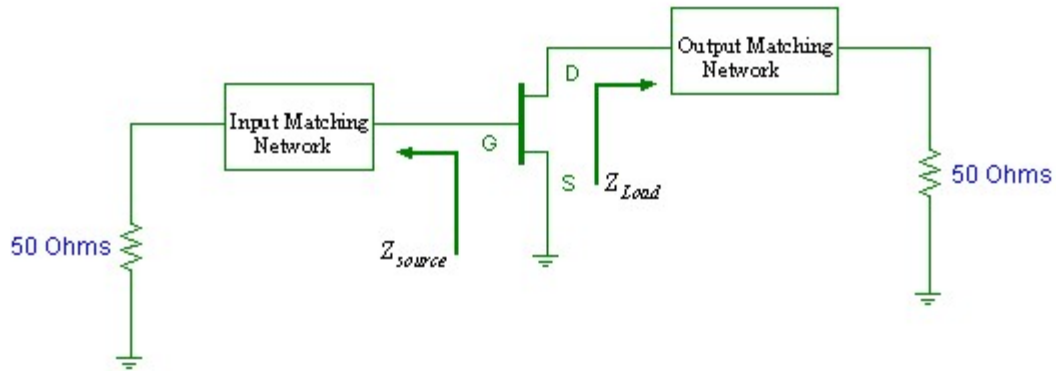

Impedance Data

Freq (GHz)	Z_{Source} (Ω)	Z_{Load} (Ω)
1.03	Contact Manufacturer	Contact Manufacturer

TEST CIRCUIT (inches)

Board Material: Roger Duroid 6010 @ H=25 mils, Er=10.2, 2 Oz Copper

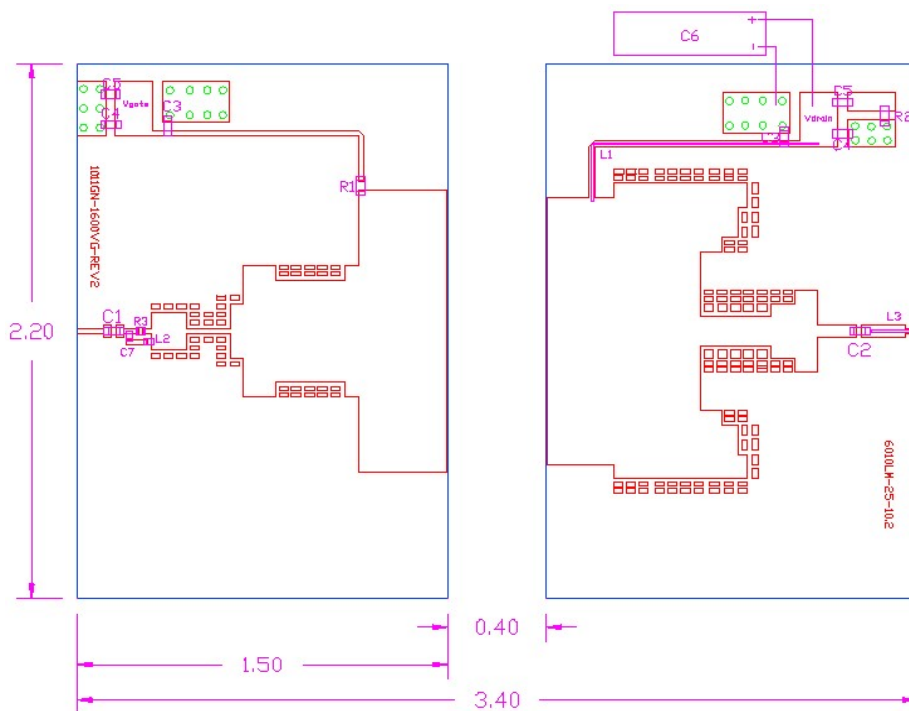

DXF file available upon request

BILL OF MATERIALS

Component List - 1011GN-1600VG

Item	Description	Supplier Part number (from Digikey & others)	Value	Note
C1	Chip Cap size 0603, 250V or 800A from ATC	251R14S101GV4T	100pF	
C2	Chip Cap from PPI (1111C101JW152X), 1500V	PPI (1111C101JW152X), 1500V	100pF	Stand it up
C3	Chip Cap size 0603, 250V or 800A from ATC	251R14S101GV4T	100pF	
C4	Chip Cap size 0805, 1000V	CAP CER 1000PF 1KV X7R 0805	1000pF	
C5	Chip Cap size 1210, 100V (digikey: 445-6043-1-ND)	CAP CER 4.7UF 100V X7S 1210	4.7uF	Stand it up
C6	Electrolytic Cap (63V)	UVR1J682MRD (for 6800µF)	1000-6800uF	
C7	Chip Cap size 0603- ATS 600S	600L9R1BT200T	9.1pF	
R1	Chip Resistor size 0805	RC0805FR-0711R5L	11.5 ohms	
R2	Chip Resistor size 0805	ERA-6AEB222V	2.2 Ohms	
R3	Chip Resistor size 0805	ERJ-6ENF3160V	316 Ohms	
L2	Chip inductor size 1608 (Venkel: LMCI1608-1N2ST)	Venkel: LMCI1608-1N2ST	1.2nH	
L1	22 AWG Copper Wire On RF Choke	Any	L=1160 Mil	
L3	22 AWG Copper Wire On RF Choke	Any	L=180 Mil	
Board: Duroid 6010LM - 25 Mil Thick - Er = 10.2, 2 Oz Copper				
== > Place small wire on top of the output 50 ohms line & Use C6=6800µF for Mode S signal				

Application Circuit (1030-1090) MHz
Board Material: Roger Duroid 6010 @ H=25 mils, Er=10.2, 2 Oz Copper

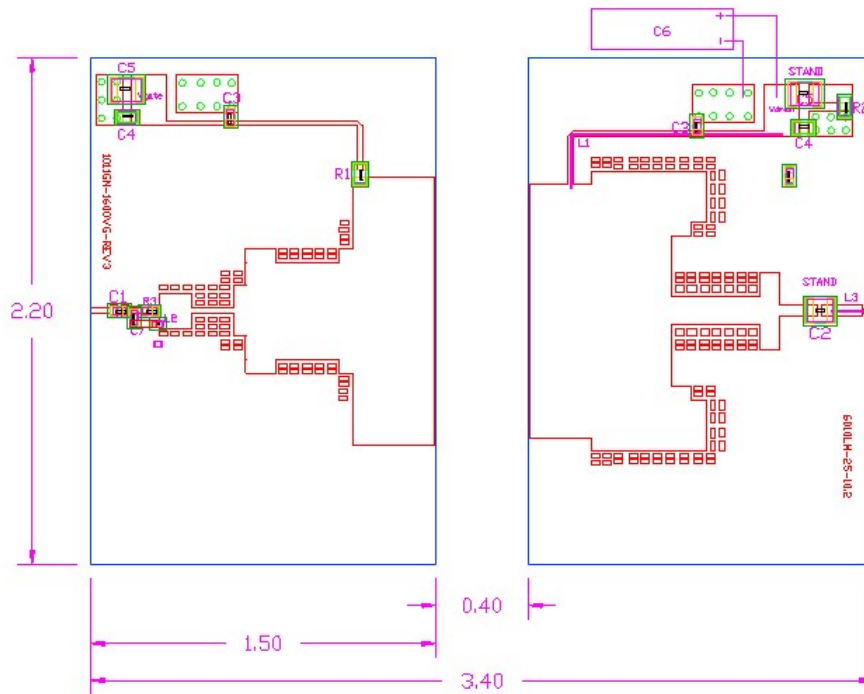

DXF file available upon request

55-Q11A PACKAGE DRAWING mm (inches)

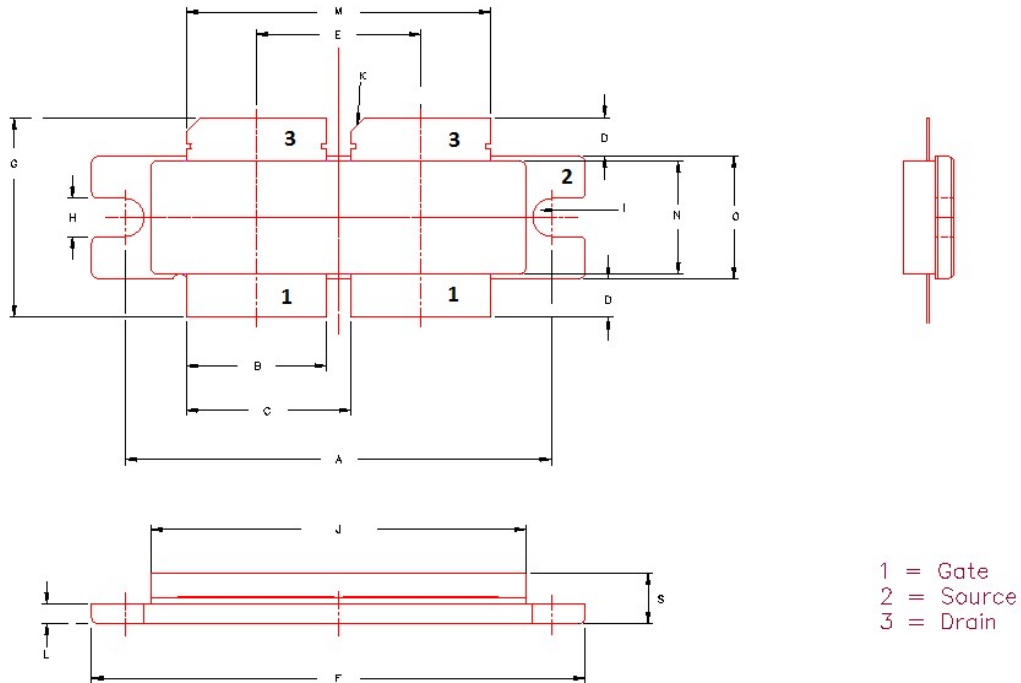

Dimension	Min (mil)	Min (mm)	Max (mil)	Max (mm)
A	1395	35.43	1405	35.68
B	450	11.43	470	11.94
C	530	13.46	550	13.97
D	117	2.97	137	3.48
E	535	13.59	545	13.84
F	1610	40.89	1630	41.40
G	644	16.36	664	16.86
H	122	3.10	128	3.25
I	R=.0625		R=1.59	
J	1218	30.93	1242	31.55
K	47 x 45°±5°		1.19x 4°±5°	
L	63	1.60	65	1.65
M	990	25.15	1010	25.65
N	365	9.27	375	9.53
O	398	10.11	406	10.31
S	158	4.01	172	4.37



1011GN-1600VG

1600 Watts • 50/52 Volts • 32us, 2%
L-Band Avionics 1030/1090 MHz

©2021 MICROCHIP Technology Inc. All rights reserved.

Trademarks and registered trademarks are the property of their respective owners.
All information herein is subject to change without notice.

Corporate Headquarters
Microchip Technology Inc.
2355 West Chandler Blvd.
Chandler, Arizona, USA 85224-6199
(480) 792-7200

Web: www.microchip.com
Email: info@microchip.com