

100 V, 1 A power Schottky rectifier

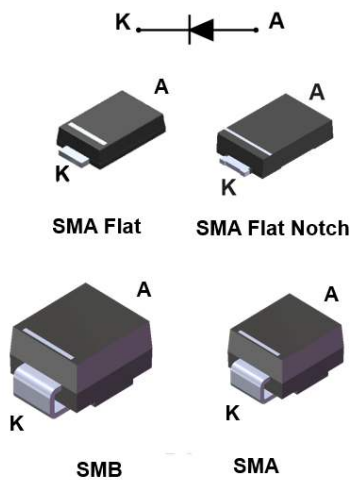

Features

- Negligible switching losses
- High junction temperature capability
- Low leakage current
- Good trade off between leakage current and forward voltage drop
- Avalanche capability specified
- [ECOPACK2](#) halogen-free component

Description

Schottky rectifiers designed for high frequency miniature switched mode power supplies such as adaptors and on board DC/DC converters.

Packaged in SMA, SMA Flat, SMA Flat Notch, or SMB, this diode is ideal for use in lighting and telecom power applications.

Product status	
STPS1H100	
Product summary	
Symbol	Value
$I_{F(AV)}$	1 A
V_{RRM}	100 V
$T_{j(max.)}$	175 °C
$V_{F(max.)}$	0.62 V

1 Characteristics

Table 1. Absolute ratings (limiting values at 25 °C, unless otherwise specified)

Symbol	Parameter	Value	Unit		
V_{RRM}	Repetitive peak reverse voltage	100	V		
$I_{F(RMS)}$	Forward rms current	10	A		
$I_{F(AV)}$	Average forward current, $\delta = 0.5$	SMA	$T_L = 150\text{ °C}$	1	A
		SMB, SMA Flat	$T_L = 155\text{ °C}$		
		SMA Flat Notch	$T_L = 160\text{ °C}$		
I_{FSM}	Surge non repetitive forward current	$t_p = 10\text{ ms sinusoidal}$	50	A	
P_{ARM}	Repetitive peak avalanche power	$t_p = 10\text{ }\mu\text{s}, T_j = 125\text{ °C}$	108	W	
T_{stg}	Storage temperature range	-65 to +175	°C		
T_j	Maximum operating junction temperature ⁽¹⁾	+175	°C		

1. $(dP_{tot}/dT_j) < (1/R_{th(j-a)})$ condition to avoid thermal runaway for a diode on its own heatsink.

Table 2. Thermal parameters

Symbol	Parameter	Max. value	Unit	
$R_{th(j-l)}$	Junction to lead	SMA	30	°C/W
		SMB	25	
		SMA Flat, SMA Flat Notch	20	

Table 3. Static electrical characteristics

Symbol	Parameter	Test conditions	Min.	Typ.	Max.	Unit
$I_R^{(1)}$	Reverse leakage current	$T_j = 25\text{ °C}$	$V_R = V_{RRM}$	-	4	μA
		$T_j = 125\text{ °C}$		-	0.2	0.5
$V_F^{(2)}$	Forward voltage drop	$T_j = 25\text{ °C}$	$I_F = 1\text{ A}$	-	0.77	V
		$T_j = 125\text{ °C}$		-	0.58	
		$T_j = 25\text{ °C}$	$I_F = 2\text{ A}$	-	0.86	
		$T_j = 125\text{ °C}$		-	0.65	

1. Pulse test: $t_p = 5\text{ ms}, \delta < 2\%$

2. Pulse test: $t_p = 380\text{ }\mu\text{s}, \delta < 2\%$

To evaluate the conduction losses, use the following equation:

$$P = 0.54 \times I_{F(AV)} + 0.08 \times I_{F(RMS)}^2$$

1.1 Characteristics (curves)

Figure 1. Average forward power dissipation versus average forward current

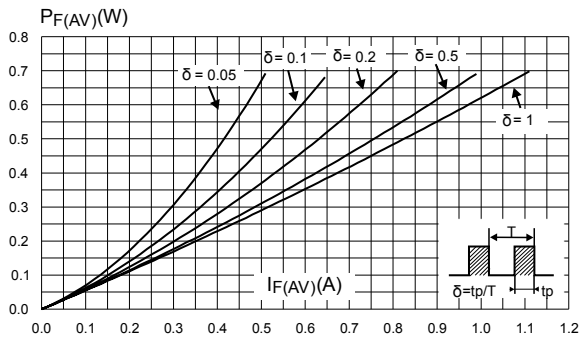

Figure 2. Average forward current versus ambient temperature ($\delta = 0.5$)

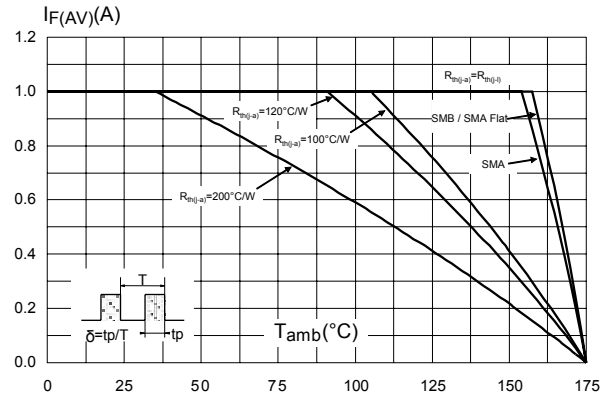

Figure 3. Normalized avalanche power derating versus junction temperature ($T_j = 125^\circ\text{C}$)

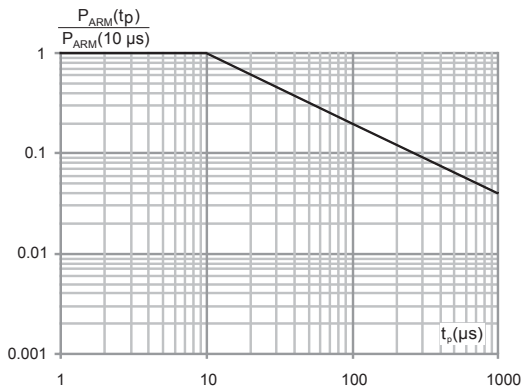

Figure 4. Junction capacitance versus reverse voltage applied (maximum values)

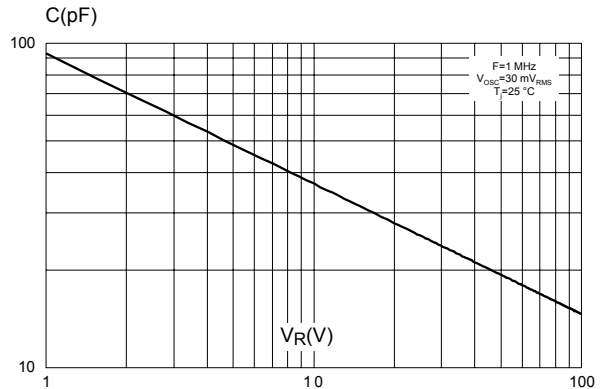

Figure 5. Relative variation of thermal impedance junction to ambient versus pulse duration

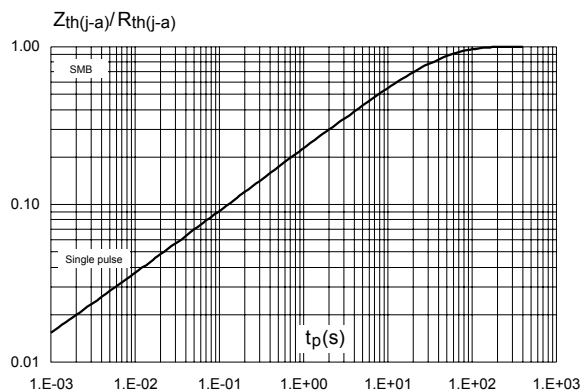

Figure 6. Relative variation of thermal impedance junction to ambient versus pulse duration

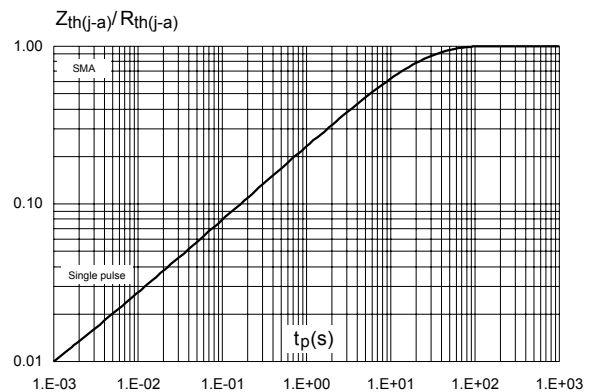

Figure 7. Relative variation of thermal impedance junction to ambient versus pulse duration

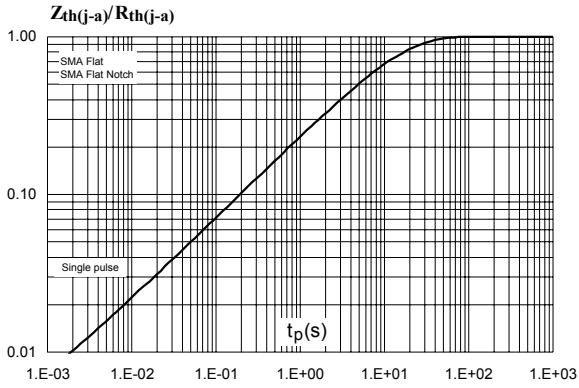

Figure 8. Reverse leakage current versus reverse voltage applied (typical values)

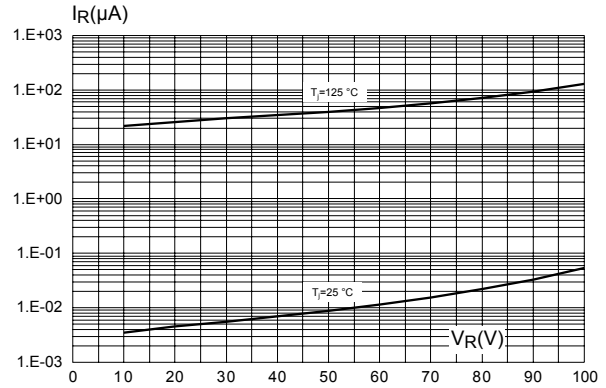

Figure 9. Forward voltage drop versus forward current (maximum values)

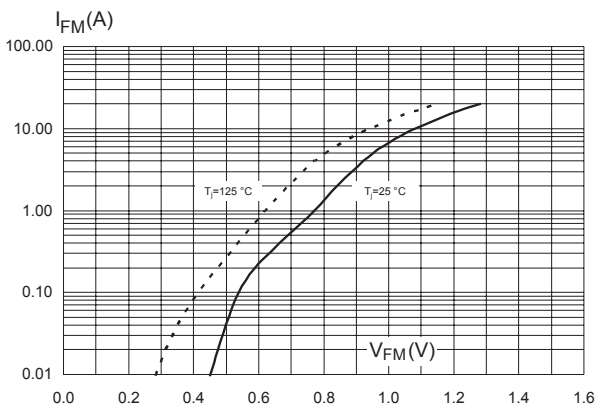

Figure 10. Thermal resistance junction to ambient versus copper surface under each lead (SMB)

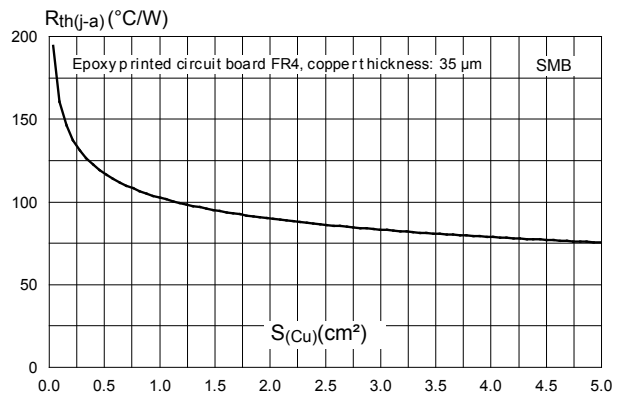

Figure 11. Thermal resistance junction to ambient versus copper surface under each lead

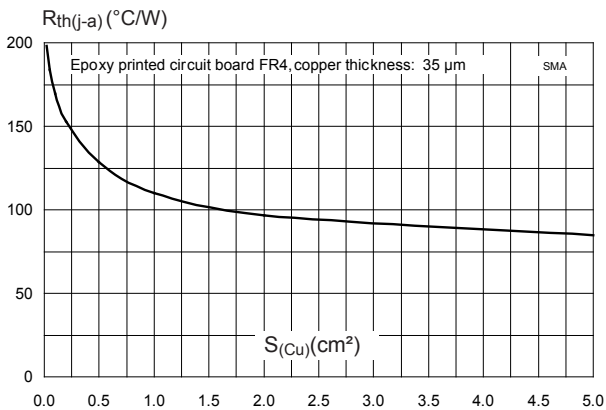
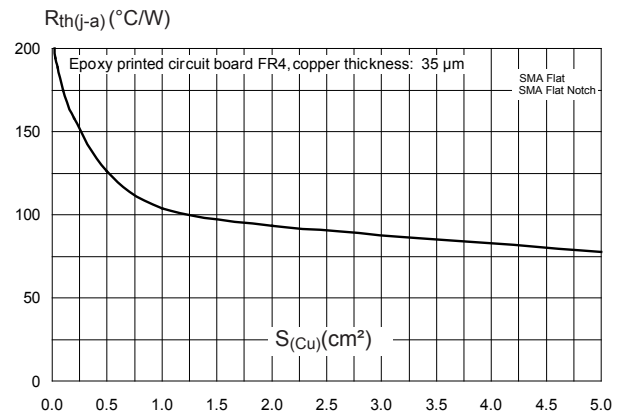

Figure 12. Thermal resistance junction to ambient versus copper surface under each lead



2 Package information

In order to meet environmental requirements, ST offers these devices in different grades of **ECOPACK** packages, depending on their level of environmental compliance. ECOPACK specifications, grade definitions and product status are available at: www.st.com. ECOPACK is an ST trademark.

2.1 SMB package information

- Epoxy meets UL94, V0
- Lead-free package

Figure 13. SMB package outline

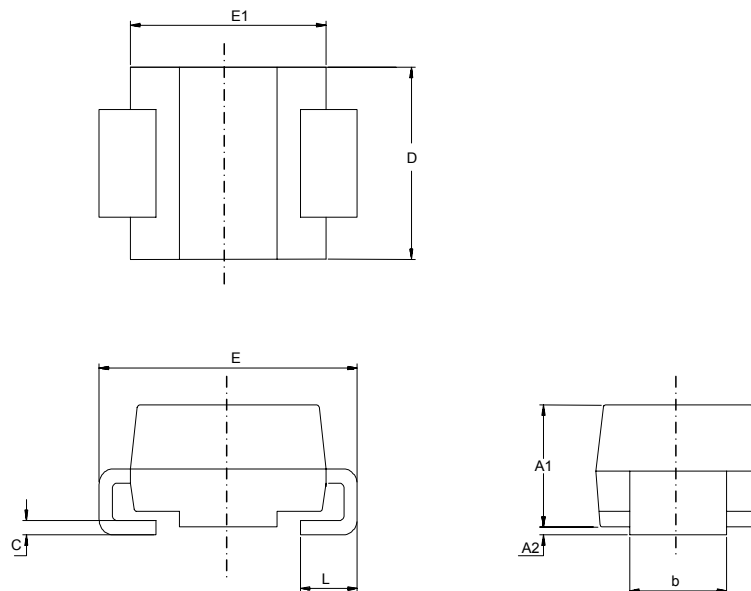
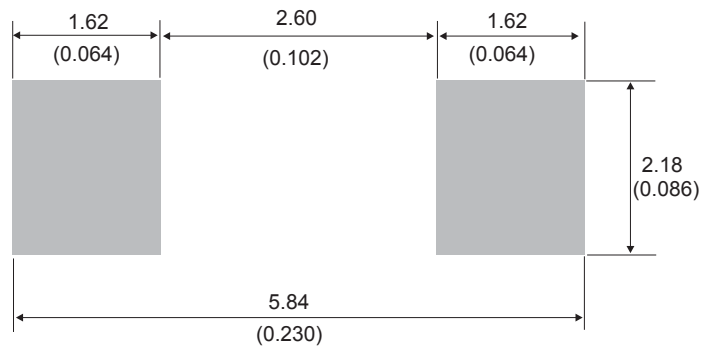

Table 4. SMB package mechanical data

Ref.	Dimensions			
	Millimeters		Inches (for reference only)	
	Min.	Max.	Min.	Max.
A1	1.90	2.45	0.0748	0.0965
A2	0.05	0.20	0.0020	0.0079
b	1.95	2.20	0.0768	0.0867
c	0.15	0.40	0.0059	0.0157
D	3.30	3.95	0.1299	0.1556
E	5.10	5.60	0.2008	0.2205
E1	4.05	4.60	0.1594	0.1811
L	0.75	1.50	0.0295	0.0591

Figure 14. SMB recommended footprint



2.2 SMA package information

- Epoxy meets UL94, V0
- Lead-free package

Figure 15. SMA package outline

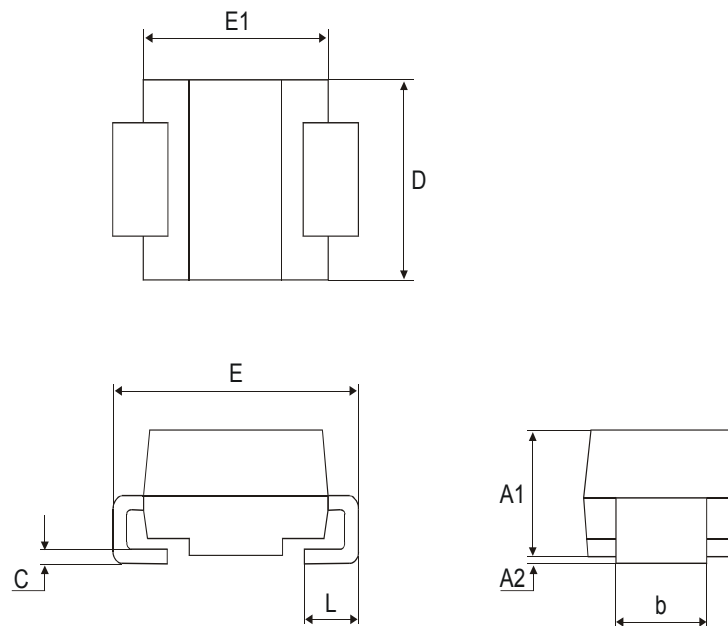
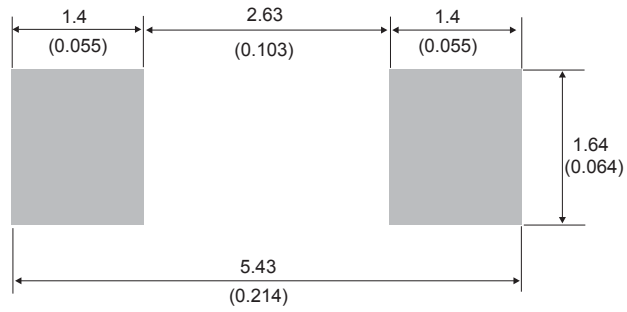

Table 5. SMA package mechanical data

Ref.	Dimensions			
	Millimeters		Inches	
	Min.	Max.	Min.	Max.
A1	1.90	2.45	0.075	0.097
A2	0.05	0.20	0.002	0.008
b	1.25	1.65	0.049	0.065
c	0.15	0.40	0.006	0.016
D	2.25	2.90	0.089	0.114
E	4.80	5.35	0.189	0.211
E1	3.95	4.60	0.156	0.181
L	0.75	1.50	0.030	0.059

Figure 16. SMA recommended footprint in mm (inches)



2.3 SMA Flat package information

- Epoxy meets UL94, V0
- Lead-free package

Figure 17. SMA Flat package outline

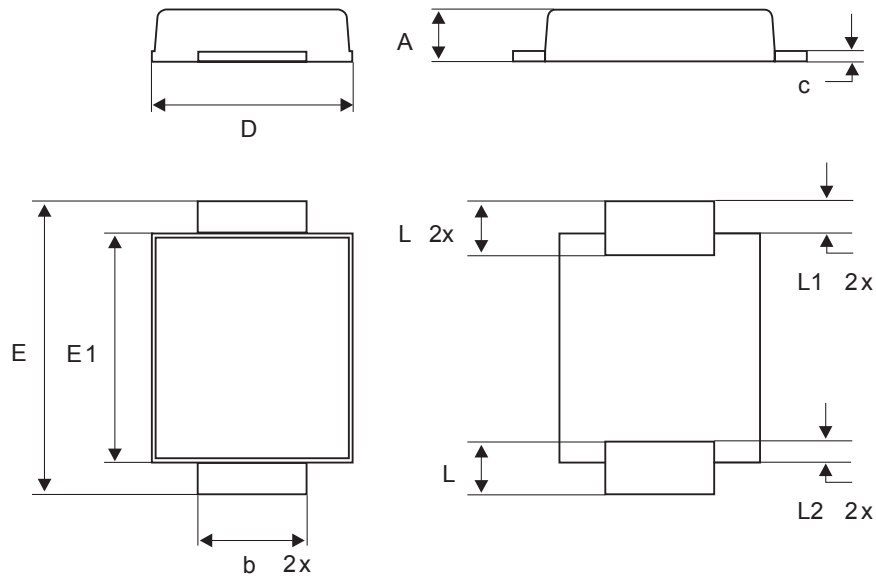
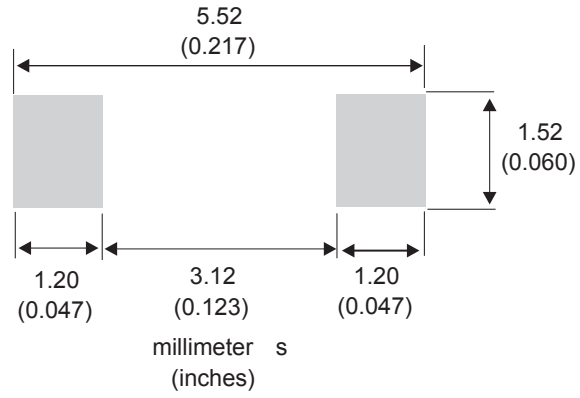

Table 6. SMA Flat package mechanical data

Ref.	Dimensions					
	Millimeters			Inches (for reference only)		
	Min.	Typ.	Max.	Min.	Typ.	Max.
A	0.90		1.10	0.035		0.044
b	1.25		1.65	0.049		0.065
c	0.15		0.40	0.005		0.016
D	2.25		2.95	0.088		0.117
E	4.80		5.60	0.188		0.221
E1	3.95		4.60	0.155		0.182
L	0.75		1.50	0.029		0.060
L1		0.50			0.020	
L2		0.50			0.020	

Figure 18. SMA Flat recommended footprint in mm (inches)



2.4 SMA Flat Notch package information

- Epoxy meets UL94, V0
- Cooling method: by conduction (C)
- Band indicates cathode

Figure 19. SMA Flat Notch package outline

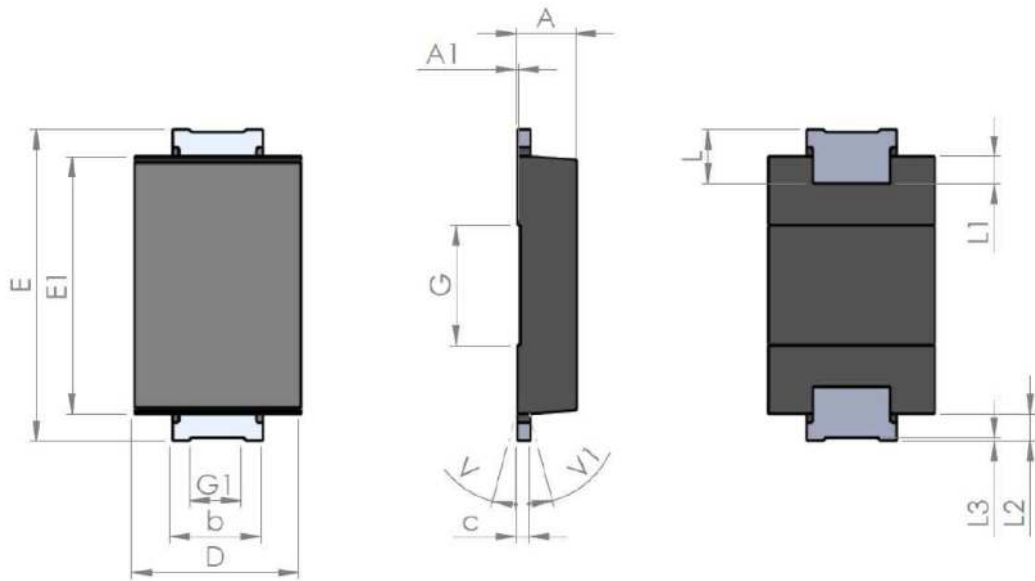
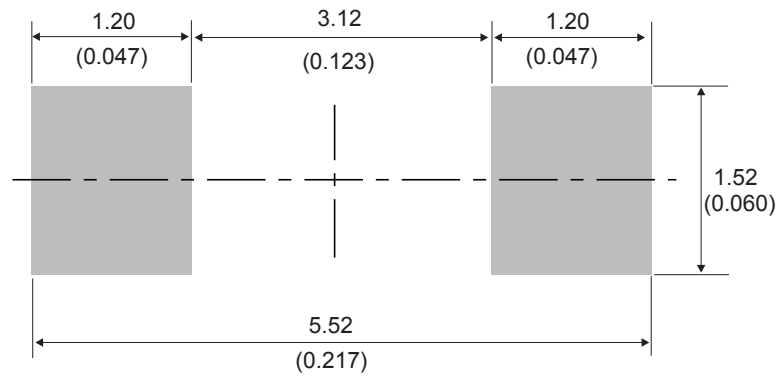

Table 7. SMA Flat Notch package mechanical data

Ref.	Dimensions					
	Millimeters			Inches (for reference only)		
	Min.	Typ.	Max.	Min.	Typ.	Max.
A1	0.90		1.10	0.035		0.044
A1		0.05			0.002	
b	1.25		1.65	0.049		0.065
C	0.15		0.40	0.005		0.016
D	2.25		2.90	0.088		0.115
E	5.00		5.35	0.196		0.211
E1	3.95		4.60	0.155		0.182
G		2.00			0.079	
G1		0.85			0.033	
L	0.75		1.20	0.029		
L1		0.45			0.018	
L2		0.45			0.018	
L3		0.05			0.002	
V			8°			8°
V1			8°			8°

Figure 20. SMA Flat Notch recommended footprint in mm (inches)



3 Ordering Information

Table 8. Ordering information

Order code	Marking	Package	Weight	Base qty.	Delivery mode
STPS1H100A	S11	SMA	0.068 g	5000	Tape and reel
STPS1H100U	G11	SMB	0.107 g	2500	Tape and reel
STPS1H100AF	F11	SMA Flat	0.035 g	10 000	Tape and reel
STPS1H100AFN	A11	SMA Flat Notch	0.039 g	10 000	Tape and reel

Revision history

Table 9. Document revision history

Date	Version	Changes
Jul-2003	4A	Last update.
Aug-2004	5	SMA package dimensions update. Reference A1 max changed from 2.70 mm (0.106 inc.) to 2.03 mm (0.080 inc).
18-Sep-2008	6	Reformatted to current standards. Added SMAflat package.
06-Apr-2018	7	Updated Table 1. Absolute ratings (limiting values at 25 °C, unless otherwise specified) , Figure 3. Normalized avalanche power derating versus junction temperature (T_j = 125 °C) . Removed "Normalized avalanche power derating versus junction temperature".
08-Oct-2019	8	Added Section 2.4 SMA Flat Notch package information .

IMPORTANT NOTICE – PLEASE READ CAREFULLY

STMicroelectronics NV and its subsidiaries (“ST”) reserve the right to make changes, corrections, enhancements, modifications, and improvements to ST products and/or to this document at any time without notice. Purchasers should obtain the latest relevant information on ST products before placing orders. ST products are sold pursuant to ST’s terms and conditions of sale in place at the time of order acknowledgement.

Purchasers are solely responsible for the choice, selection, and use of ST products and ST assumes no liability for application assistance or the design of Purchasers’ products.

No license, express or implied, to any intellectual property right is granted by ST herein.

Resale of ST products with provisions different from the information set forth herein shall void any warranty granted by ST for such product.

ST and the ST logo are trademarks of ST. For additional information about ST trademarks, please refer to www.st.com/trademarks. All other product or service names are the property of their respective owners.

Information in this document supersedes and replaces information previously supplied in any prior versions of this document.

© 2019 STMicroelectronics – All rights reserved