

Features

- Epitaxial Planar Die Construction
- Complementary PNP Types Available (DDTA)
- Built-In Biasing Resistors, R1≠R2
- **Lead Free/RoHS Compliant (Note 2)**
- **"Green" Device (Note 3 and 4)**

Mechanical Data

- Case: SOT-523
- Case Material: Molded Plastic. UL Flammability Classification Rating 94V-0
- Moisture Sensitivity: Level 1 per J-STD-020C
- Terminals: Solderable per MIL-STD-202, Method 208
- Lead Free Plating (Matte Tin Finish annealed over Alloy 42 leadframe)
- Terminal Connections: See Diagram
- Marking & Date Code Information: See Table Below & Page 4
- Ordering Information: See Page 4
- Weight: 0.002 grams (approximate)

P/N	R1 (NOM)	R2 (NOM)	Marking
DDTC113ZE	1KΩ	10KΩ	N02
DDTC123YE	2.2KΩ	10KΩ	N05
DDTC123JE	2.2KΩ	47KΩ	N06
DDTC143XE	4.7KΩ	10KΩ	N09
DDTC143FE	4.7KΩ	22KΩ	N10
DDTC143ZE	4.7KΩ	47KΩ	N11
DDTC114YE	10KΩ	47KΩ	N14
DDTC114WE	10KΩ	4.7KΩ	N15
DDTC124XE	22KΩ	47KΩ	N18
DDTC144VE	47KΩ	10KΩ	N21
DDTC144WE	47KΩ	22KΩ	N22

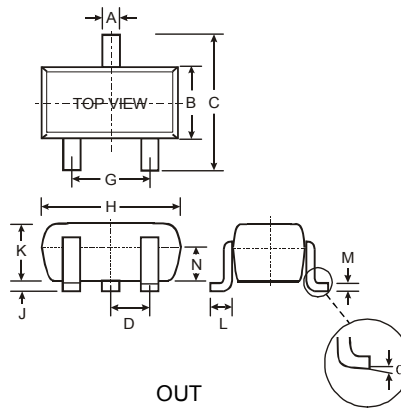

SOT-523			
Dim	Min	Max	Typ
A	0.15	0.30	0.22
B	0.75	0.85	0.80
C	1.45	1.75	1.60
D	—	—	0.50
G	0.90	1.10	1.00
H	1.50	1.70	1.60
J	0.00	0.10	0.05
K	0.60	0.80	0.75
L	0.10	0.30	0.22
M	0.10	0.20	0.12
N	0.45	0.65	0.50
α	0°	8°	—

All Dimensions in mm

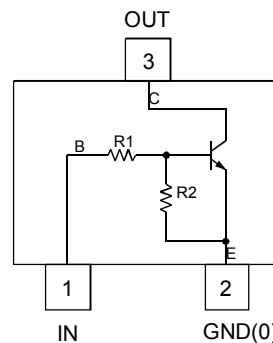

Schematic and Pin Configuration

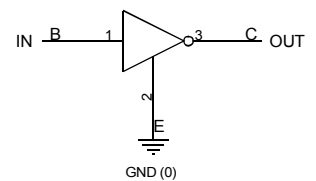

Equivalent Inverter Circuit

Maximum Ratings @_TA = 25°C unless otherwise specified

Characteristic	Symbol	Value	Unit
Supply Voltage (3) to (2)	V _{CC}	50	V
Input Voltage, (1) to (2)	V _{IN}	DDTC113ZE: -5 to +10 DDTC123YE: -5 to +12 DDTC123JE: -5 to +12 DDTC143XE: -7 to +20 DDTC143FE: -6 to +30 DDTC143ZE: -5 to +30 DDTC114YE: -6 to +40 DDTC114WE: -10 to +30 DDTC124XE: -10 to +40 DDTC144VE: -15 to +40 DDTC144WE: -10 to +40	V
Output Current	I _O	DDTC113ZE: 100 DDTC123YE: 100 DDTC123JE: 100 DDTC143XE: 100 DDTC143FE: 100 DDTC143ZE: 100 DDTC114YE: 70 DDTC114WE: 100 DDTC124XE: 50 DDTC144VE: 30 DDTC144WE: 30	mA
Output Current	I _C (Max)	All: 100	mA

- Notes:
1. Mounted on FR4 PC Board with recommended pad layout at <http://www.diodes.com/datasheets/ap02001.pdf>.
 2. No purposefully added lead.
 3. Diodes Inc.'s "Green" policy can be found on our website at http://www.diodes.com/products/lead_free/index.php.
 4. Product manufactured with Date Code UO (week 40, 2007) and newer are built with Green Molding Compound. Product manufactured prior to Date Code UO are built with Non-Green Molding Compound and may contain Halogens or Sb2O3 Fire Retardants.

Thermal Characteristics @ $T_A = 25^\circ\text{C}$ unless otherwise specified

Characteristic	Symbol	Value	Unit
Power Dissipation	P_d	150	mW
Thermal Resistance, Junction to Ambient Air (Note 1)	$R_{\theta JA}$	833	$^\circ\text{C}/\text{W}$
Operating and Storage Temperature Range	T_j, T_{STG}	-55 to +150	$^\circ\text{C}$

Electrical Characteristics @ $T_A = 25^\circ\text{C}$ unless otherwise specified

Characteristic	Symbol	Min	Typ	Max	Unit	Test Condition	
Input Voltage	$V_{I(off)}$	DDTC113ZE	0.3			V	$V_{CC} = 5V, I_O = 100\mu\text{A}$
		DDTC123YE	0.3				
DDTC123JE		0.5					
DDTC143XE		0.3					
DDTC143FE		0.3					
DDTC143ZE		0.5					
DDTC114YE		0.3					
DDTC114WE		0.8					
DDTC124XE		0.4					
DDTC144VE		1.0					
DDTC144WE		0.8					
Input Voltage	$V_{I(on)}$	DDTC113ZE			3.0	V	$V_O = 0.3V, I_O = 20\text{mA}$ $V_O = 0.3V, I_O = 20\text{mA}$ $V_O = 0.3V, I_O = 5\text{mA}$ $V_O = 0.3V, I_O = 20\text{mA}$ $V_O = 0.3V, I_O = 3\text{mA}$ $V_O = 0.3V, I_O = 5\text{mA}$ $V_O = 0.3V, I_O = 1\text{mA}$ $V_O = 0.3V, I_O = 2\text{mA}$ $V_O = 0.3V, I_O = 2\text{mA}$ $V_O = 0.3V, I_O = 2\text{mA}$ $V_O = 0.3V, I_O = 2\text{mA}$
		DDTC123YE			3.0		
		DDTC123JE			1.1		
		DDTC143XE			2.5		
		DDTC143FE			1.3		
		DDTC143ZE			1.3		
		DDTC114YE			1.4		
		DDTC114WE			3.0		
		DDTC124XE			2.5		
		DDTC144VE			5.0		
		DDTC144WE			4.0		
Output Voltage	$V_{O(on)}$		0.1	0.3	V	$I_O/I_I = 5\text{mA}/0.25\text{mA}$ DDTC123JE $I_O/I_I = 5\text{mA}/0.25\text{mA}$ DDTC143ZE $I_O/I_I = 5\text{mA}/0.25\text{mA}$ DDTC114YE $I_O/I_I = 10\text{mA}/0.5\text{mA}$ All Others	
Input Current	I_I	DDTC113ZE			7.2	mA	$V_I = 5V$
		DDTC123YE			3.8		
		DDTC123JE			3.6		
		DDTC143XE			1.8		
		DDTC143FE			1.8		
		DDTC143ZE			1.8		
		DDTC114YE			0.88		
		DDTC114WE			0.88		
		DDTC124XE			0.36		
		DDTC144VE			0.16		
		DDTC144WE			0.16		
Output Current	$I_{O(off)}$			0.5	μA	$V_{CC} = 50V, V_I = 0V$	
DC Current Gain	G_I	DDTC113ZE	33				$V_O = 5V, I_O = 5\text{mA}$ $V_O = 5V, I_O = 10\text{mA}$ $V_O = 5V, I_O = 10\text{mA}$ $V_O = 5V, I_O = 10\text{mA}$ $V_O = 5V, I_O = 10\text{mA}$ $V_O = 5V, I_O = 10\text{mA}$ $V_O = 5V, I_O = 5\text{mA}$ $V_O = 5V, I_O = 10\text{mA}$ $V_O = 5V, I_O = 5\text{mA}$ $V_O = 5V, I_O = 5\text{mA}$ $V_O = 5V, I_O = 5\text{mA}$
		DDTC123YE	33				
		DDTC123JE	80				
		DDTC143XE	30				
		DDTC143FE	68				
		DDTC143ZE	80				
		DDTC114YE	68				
		DDTC114WE	24				
		DDTC124XE	68				
		DDTC144VE	33				
		DDTC144WE	56				
Input Resistor Tolerance	ΔR_1	-30		+30	%		
Resistance Ratio Tolerance	$\Delta R_2/R_1$	-20		+20	%		
Gain-Bandwidth Product*	f_T		250		MHz	$V_{CE} = 10V, I_E = 5\text{mA}, f = 100\text{MHz}$	

* Transistor – For Reference Only

TYPICAL CURVES – DDTC123JE

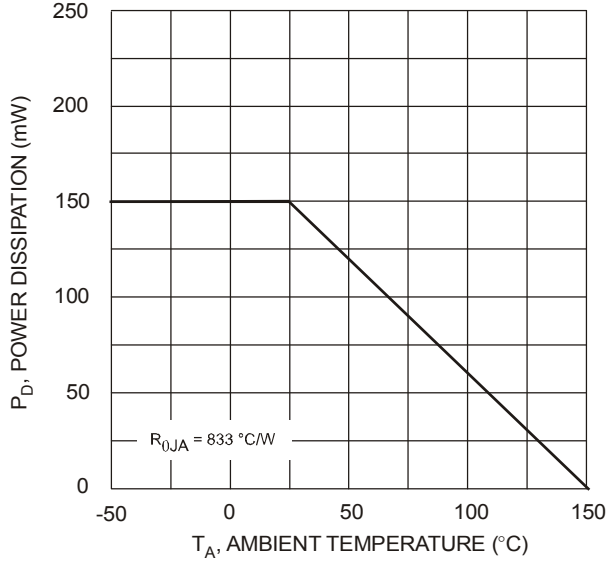

Fig. 1 Derating Curve

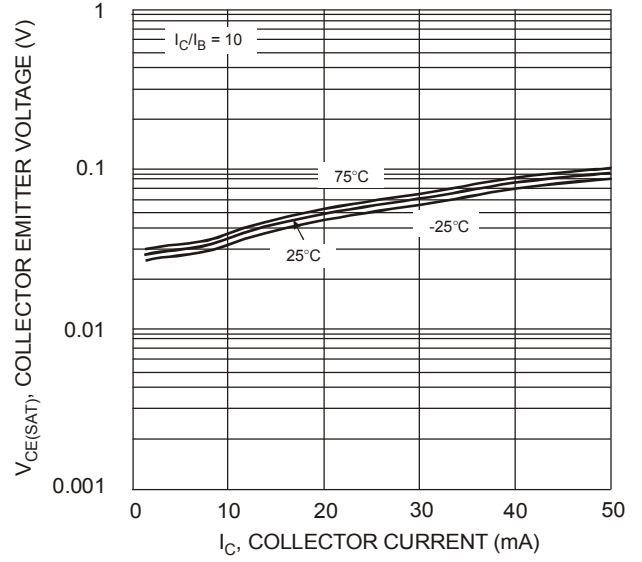

Fig. 2 $V_{CE(SAT)}$ vs. I_C

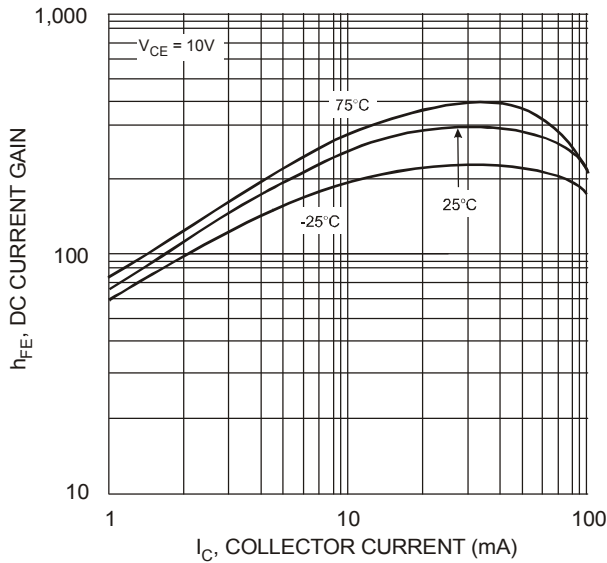

Fig. 3 DC Current Gain

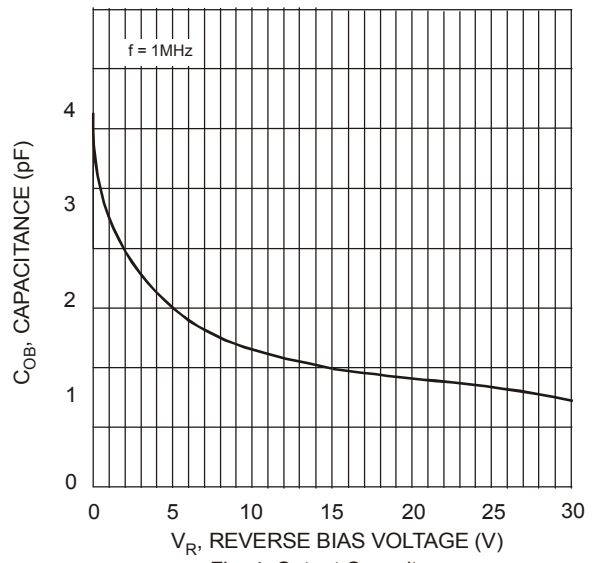

Fig. 4 Output Capacitance

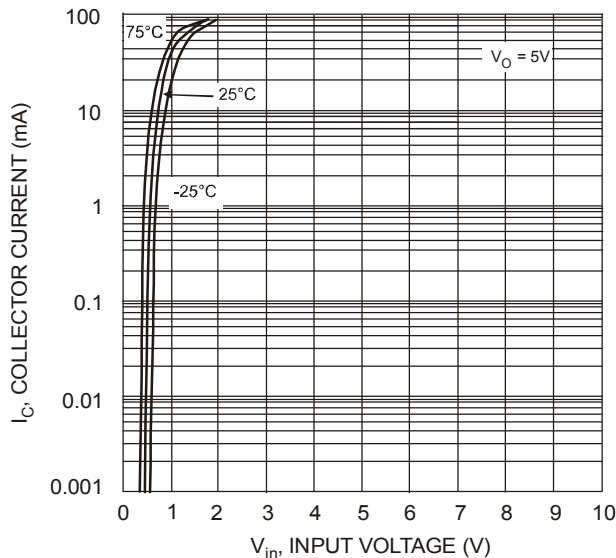

Fig. 5 Collector Current vs. Input Voltage

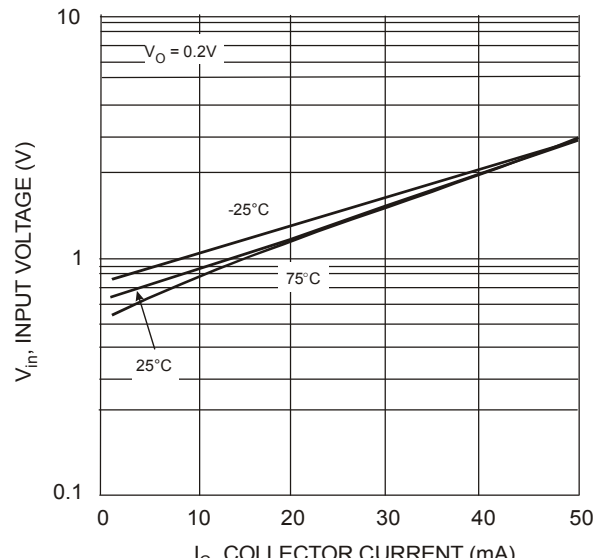

Fig. 6 Input Voltage vs. Collector Current

Ordering Information (Note 5)

Device	Packaging	Shipping
DDTC113ZE-7-F	SOT-523	3000/Tape & Reel
DDTC123YE-7-F	SOT-523	3000/Tape & Reel
DDTC123JE-7-F	SOT-523	3000/Tape & Reel
DDTC143XE-7-F	SOT-523	3000/Tape & Reel
DDTC143FE-7-F	SOT-523	3000/Tape & Reel
DDTC143ZE-7-F	SOT-523	3000/Tape & Reel
DDTC114YE-7-F	SOT-523	3000/Tape & Reel
DDTC114WE-7-F	SOT-523	3000/Tape & Reel
DDTC124XE-7-F	SOT-523	3000/Tape & Reel
DDTC144VE-7-F	SOT-523	3000/Tape & Reel
DDTC144WE-7-F	SOT-523	3000/Tape & Reel

Notes: 5. For packaging details, go to our website at <http://www.diodes.com/datasheets/ap02007.pdf>.

Marking Information

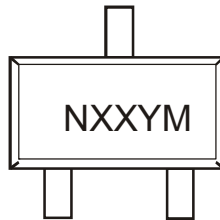

Nxx = Product Type Marking Code (See Page 1, e.g. N02 = DDTC113ZE)
 YM = Date Code Marking
 Y = Year ex: T = 2006
 M = Month ex: 9 = September

Date Code Key

Year	2002	2003	2004	2005	2006	2007	2008	2009	2010	2011	2012
Code	N	P	R	S	T	U	V	W	X	Y	Z

Month	Jan	Feb	Mar	Apr	May	Jun	Jul	Aug	Sep	Oct	Nov	Dec
Code	1	2	3	4	5	6	7	8	9	O	N	D

IMPORTANT NOTICE

Diodes Incorporated and its subsidiaries reserve the right to make modifications, enhancements, improvements, corrections or other changes without further notice to any product herein. Diodes Incorporated does not assume any liability arising out of the application or use of any product described herein; neither does it convey any license under its patent rights, nor the rights of others. The user of products in such applications shall assume all risks of such use and will agree to hold Diodes Incorporated and all the companies whose products are represented on our website, harmless against all damages.

LIFE SUPPORT

Diodes Incorporated products are not authorized for use as critical components in life support devices or systems without the expressed written approval of the President of Diodes Incorporated.