

DATASHEET

Lepida

SR4L054 • lamiiANT[®]



Features

- Lepida is a high performance antenna for 5G, 4G and LTE applications
- The antenna supports the following bands: B71 (617-698 MHz), LTE 700, GSM850, GSM900, DCS1800, PCS1900, WCDMA2100, B7 (2500-2690 MHz), B40 (2300 – 2400 MHz), B78 (3300-3800MHz)
- Lepida's unique design delivers high efficiency across all bands: DFI (Designed for Integration)
- This antenna is especially suitable for applications demanding the highest performance and/or high reliability applications e.g. automotive and aerospace
- The robust design ensures excellent coplanarity and is very resistant to bow and twist during re-flow.
- Dimensions: (50.6 x 10.6 x 3.3)
- Surface Mount Device (SMD) supplied in Tape & Reel
- ROHS and REACH Compliant

Contents

1.	Description	2
2.	Applications	2
3.	General data	2
4.	Part number	3
5.	RF characteristics	3
6.	RF performance	4
6.1.	Return loss	4
6.2.	VSWR	4
6.3.	Efficiency	5
6.4.	Antenna pattern	6
7.	Antenna dimensions	13
8.	Schematic symbol and pin definition	14
9.	Antenna footprint	14
10.	Electrical interface	15
10.1.	Transmission line	15
10.2.	Matching circuit	15
11.	Antenna integration guide	16
11.1.	Antenna placement	16
11.2.	Host PCB layout	16
11.3.	Host PCB clearance	17
12.	Reference board	18
12.1.	Reference board matching circuit	18
13.	Soldering	19
14.	Hazardous material regulation conformance	19
15.	Packaging	19
15.1.	Optimal storage conditions	19
15.2.	Tape characteristics	20
15.3.	Reel dimensions	21
15.4.	Box dimensions	21
15.5.	Bag properties	22
15.6.	Reel label information	22

1. Description

The Lepida wide-band 5G/4G antenna is part of Antenova's lamiiANT family of surface mount antennas. Lepida's unique design delivers the highest efficiency across a 600MHz to 3800MHz spectrum. Lepida requires a ground plane on the host PCB to radiate effectively and the antenna itself requires a clearance underneath. Depending on the device environment, Lepida requires an external matching circuit to tune the antenna within the target device. Antenova provides a matching service to assist our customers optimise antenna efficiency, for further details please contact your local Antenova office.

The device comes supplied on tape and reel for ease of manufacturing via pick and place.

2. Applications

Lepida is ideally suited to applications demanding the highest performance and/or high reliability applications including:

- Automotive
- Aerospace/UAVs
- Smart metering
- Remote monitoring
- 5G router

3. General data

FREQUENCY	617 – 698 MHz 698 – 798 MHz 824 – 960 MHz 1710 – 2170 MHz 2300 – 2400 MHz 2500 – 2690 MHz 3300 – 3800 MHz
POLARIZATION	Linear
OPERATING TEMPERATURE	-40°C to 140°C
ENVIRONMENTAL CONDITION TEST	ISO16750-4 5.1.1.1/5.1.2.1/5.3.2
IMPEDANCE WITH MATCHING	50 Ω
WEIGHT	4.0g
ANTENNA TYPE	SMD
DIMENSIONS	50.6 x 10.6 x 3.3 (mm)

4. Part number

LEPIDA
SR4L054



5. RF characteristics

	617-798MHZ	824-960MHZ	1710-2170MHZ
PEAK GAIN	0.50dBi	1.00dBi	2.50dBi
AVERAGE GAIN (LINEAR)	-1.50dBi	-1.50dBi	-1.50dBi
AVERAGE EFFICIENCY	>55%	>65%	>65%
MAXIMUM RETURN LOSS	-6dB	-6dB	-6dB
MAXIMUM VSWR	2.2:1	2.5:1	2.5:1

	2300-2400MHZ	2500-2690MHZ	3300-3800MHZ
PEAK GAIN	1.60dBi	0.50dBi	1.00dBi
AVERAGE GAIN (LINEAR)	-2.00dBi	-1.50dBi	-1.50dBi
AVERAGE EFFICIENCY	>65%	>65%	>65%
MAXIMUM RETURN LOSS	-10dB	-10dB	-5dB
MAXIMUM VSWR	2.1:1	1.8:1	3.8:1

All data measured on Antenova's evaluation PCB Part
No. SR4L054-EVB-2

6. RF performance

6.1. Return loss

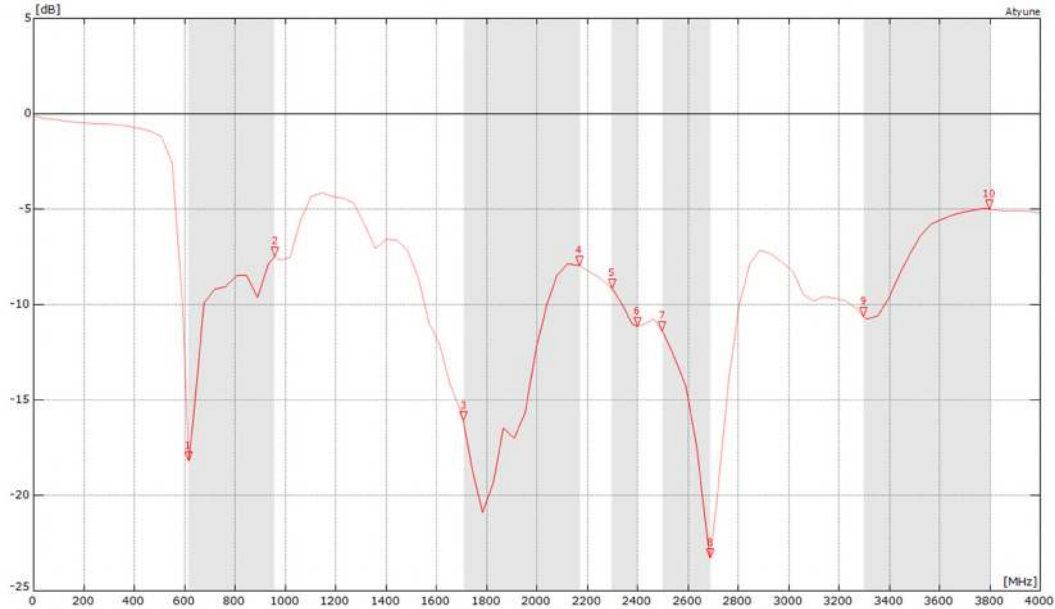

6.2. VSWR

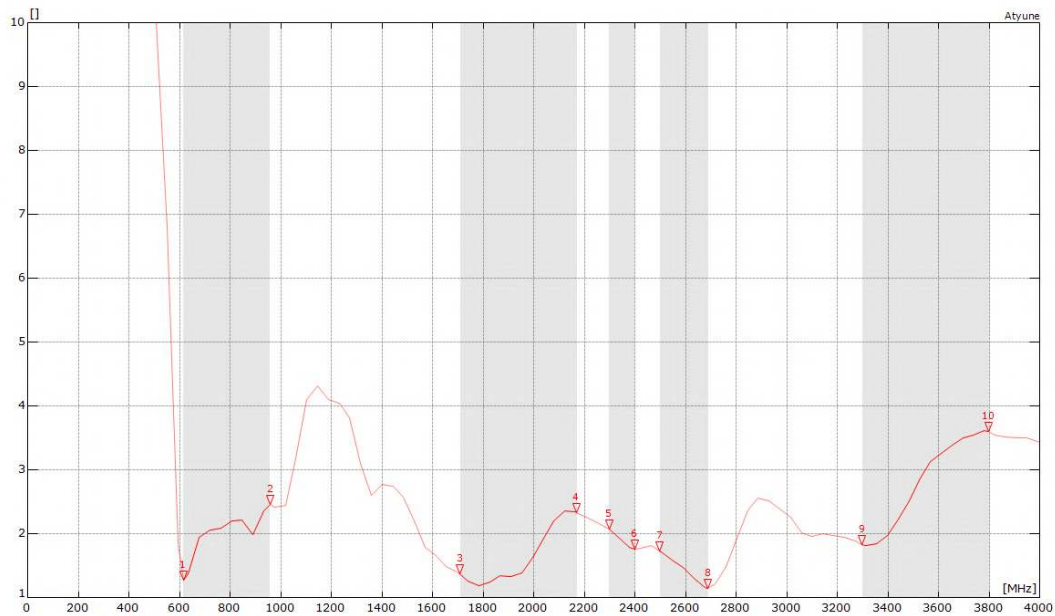

6.3. Efficiency

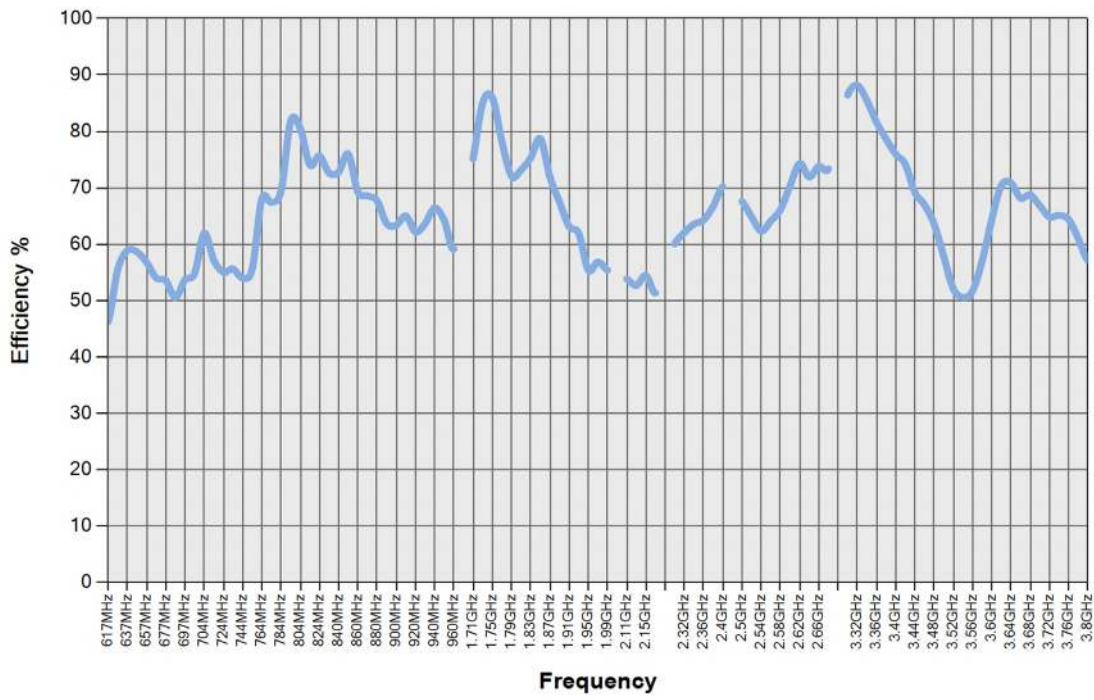

6.4. Antenna pattern

6.4.1. 617 MHz – 698MHz

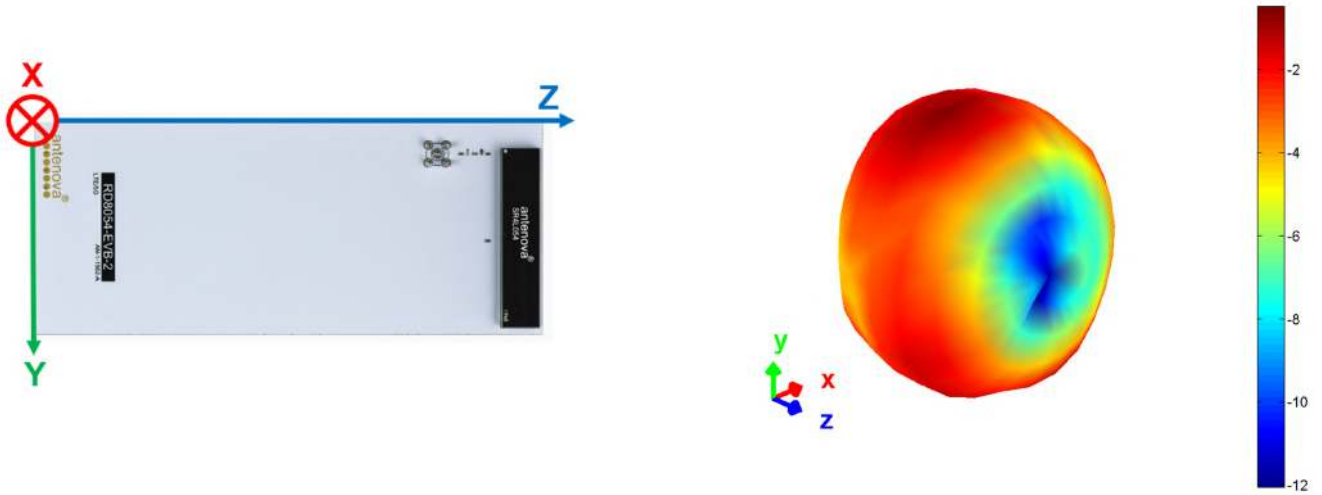

3D pattern at 657MHz

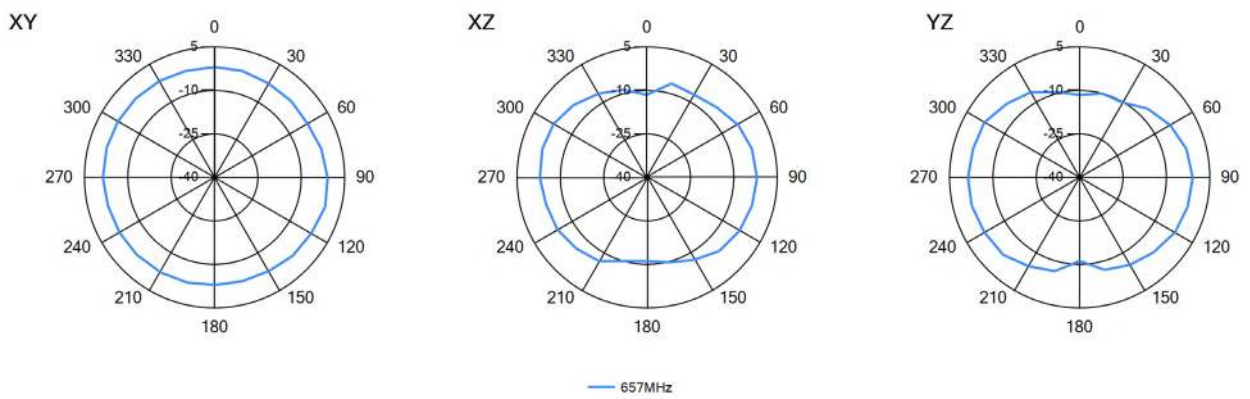

6.4.2. 698 MHz – 798 MHz

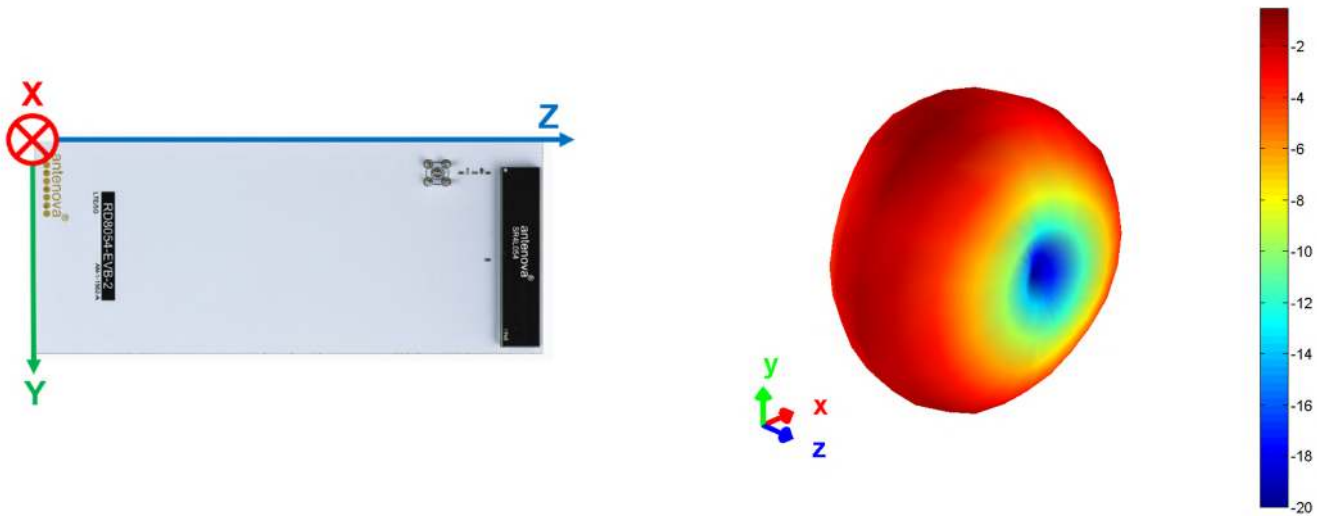

3D pattern at 734MHz

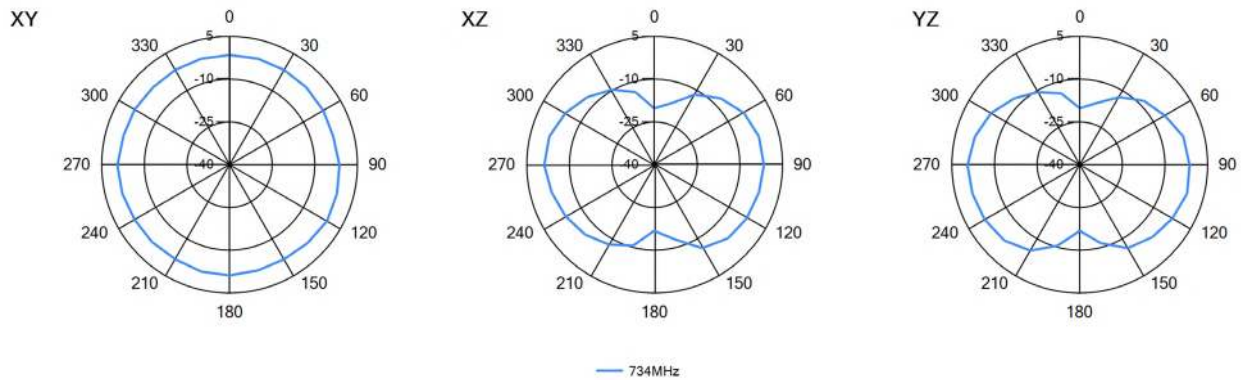

6.4.3. 824 MHz – 960 MHz

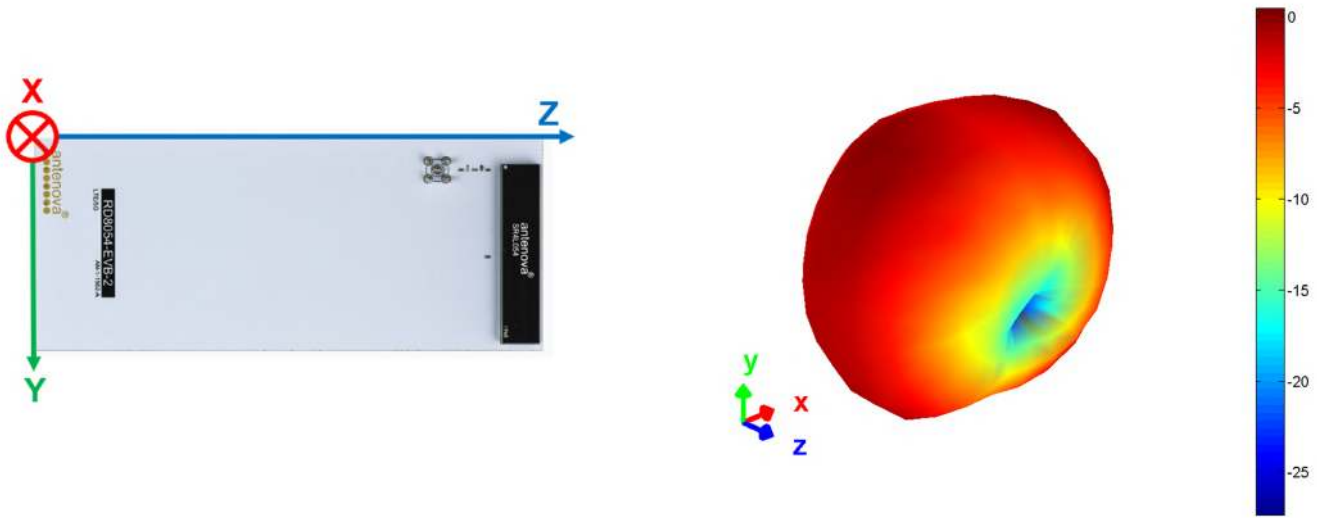

3D pattern at 900MHz

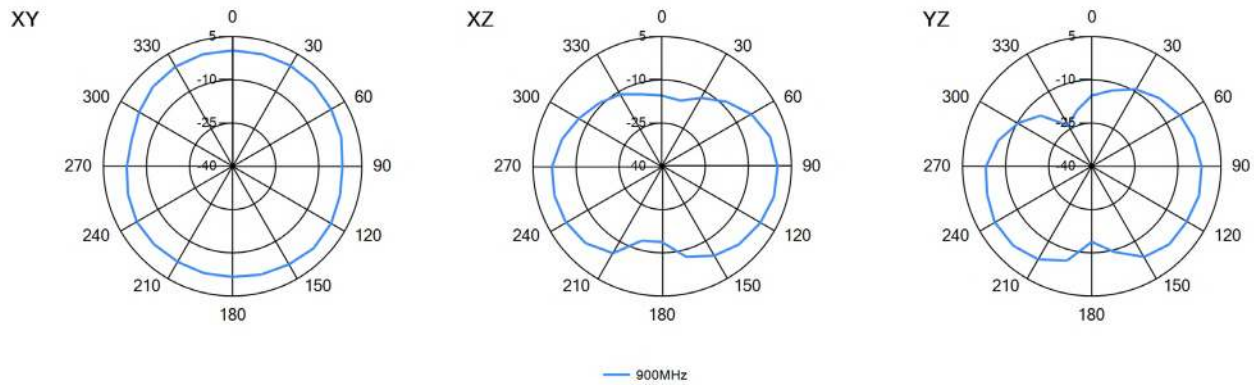

6.4.4. 1710 MHz – 2170 MHz

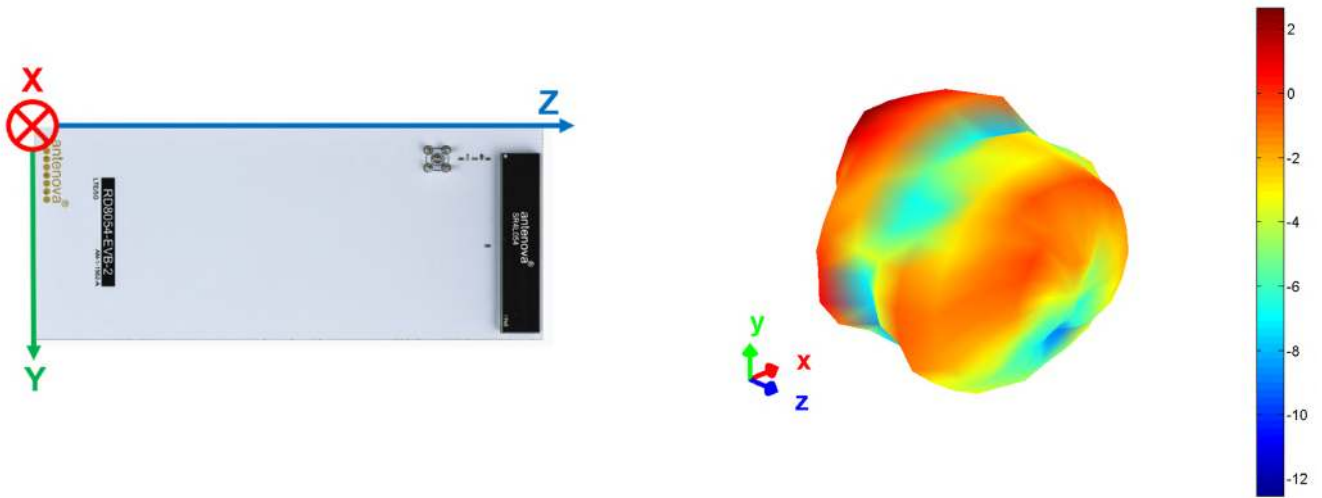

3D pattern at 1930MHz

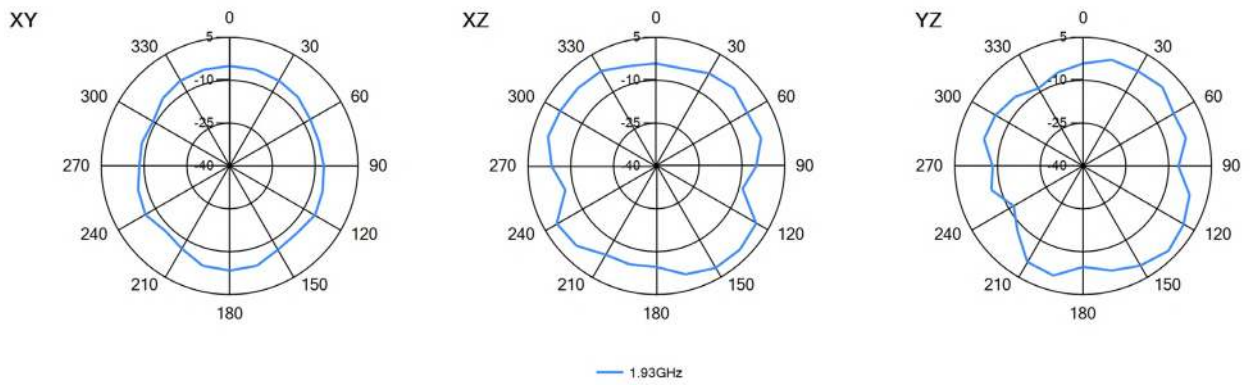

6.4.5. 2300 MHz – 2400 MHz

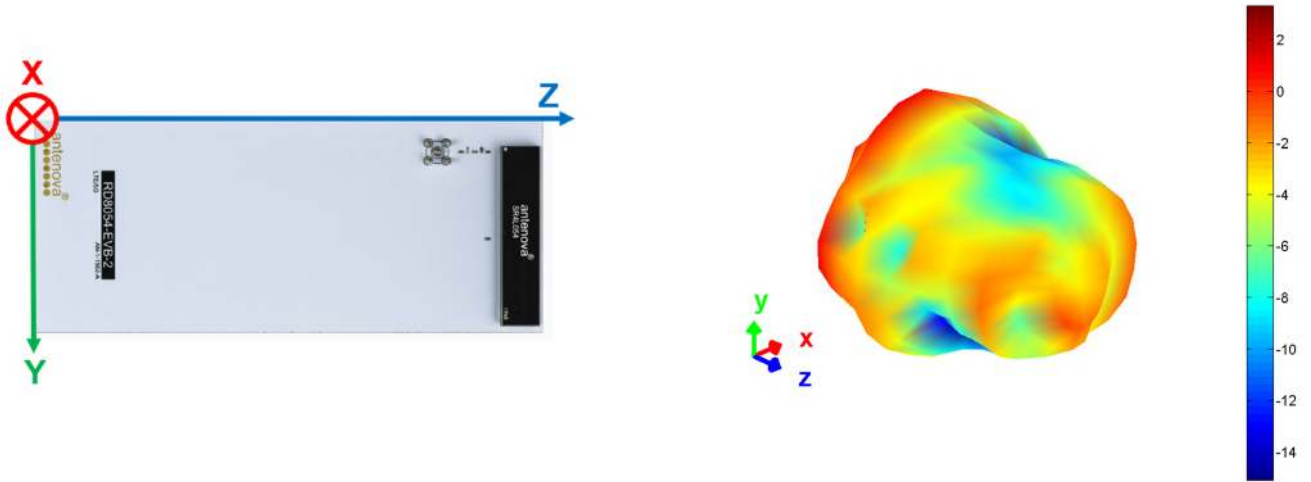

3D pattern at 2340MHz

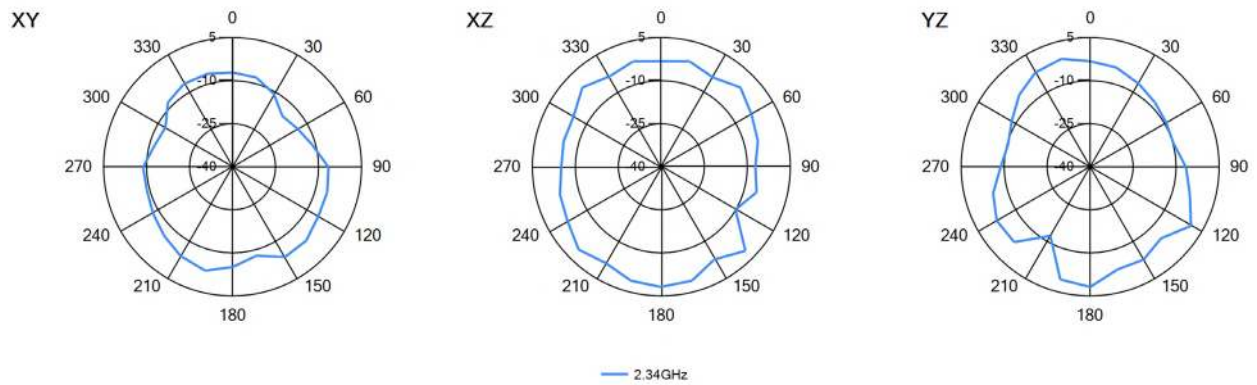

6.4.6. 2500 MHz – 2690 MHz

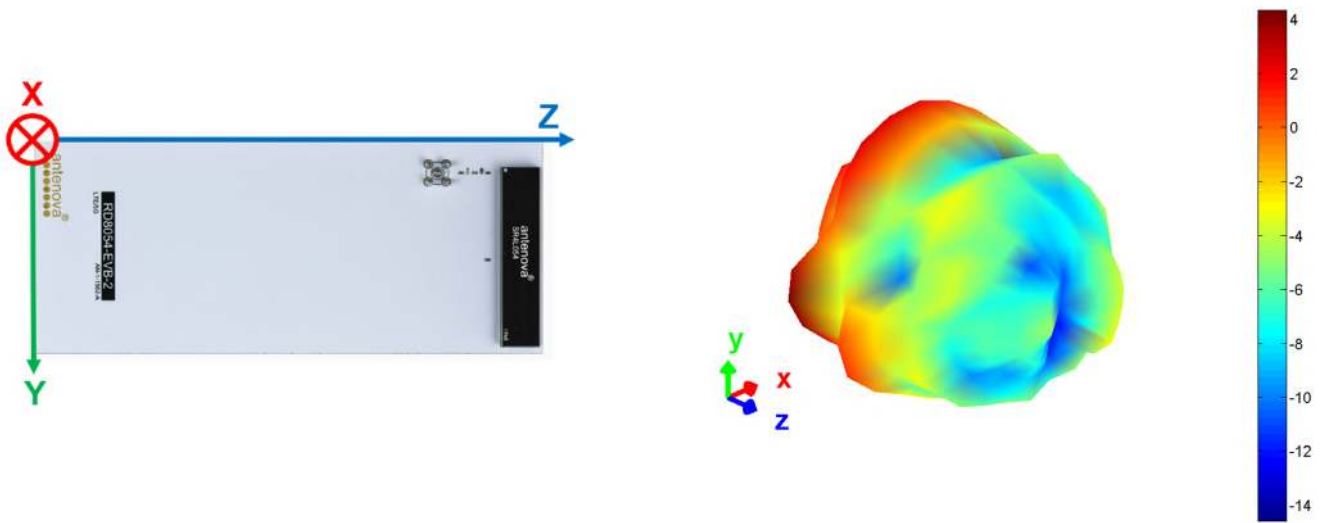

3D pattern at 2600MHz

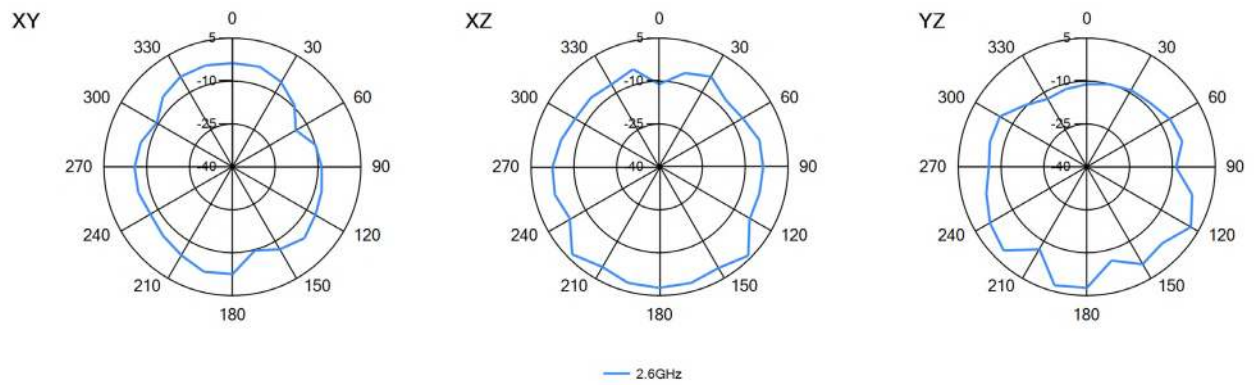

6.4.7. 3300 MHz – 3800 MHz

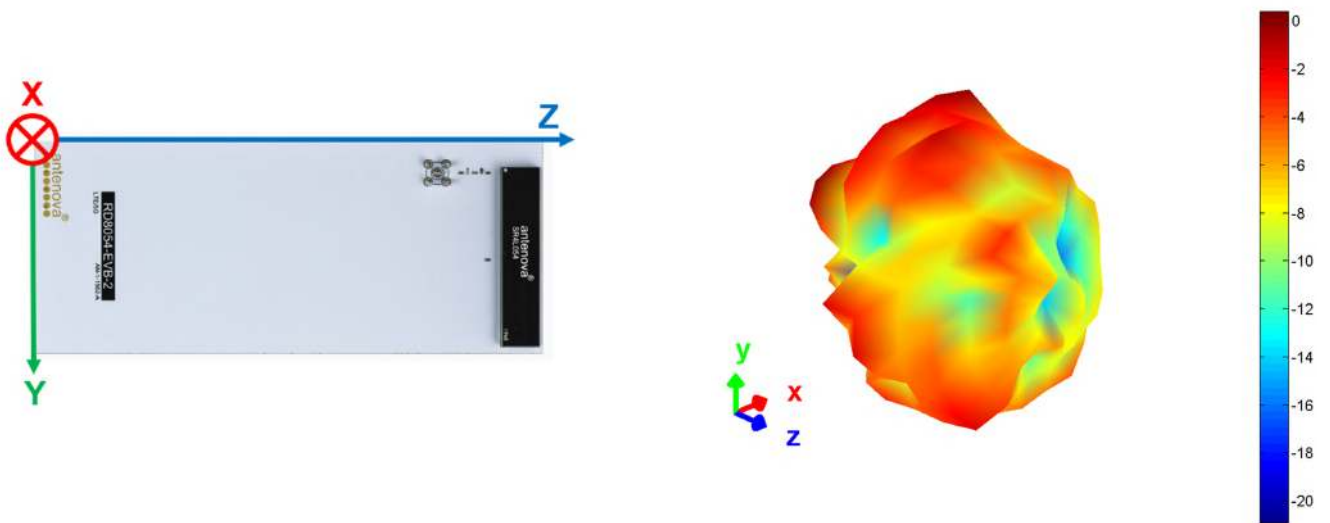

3D pattern at 3540MHz

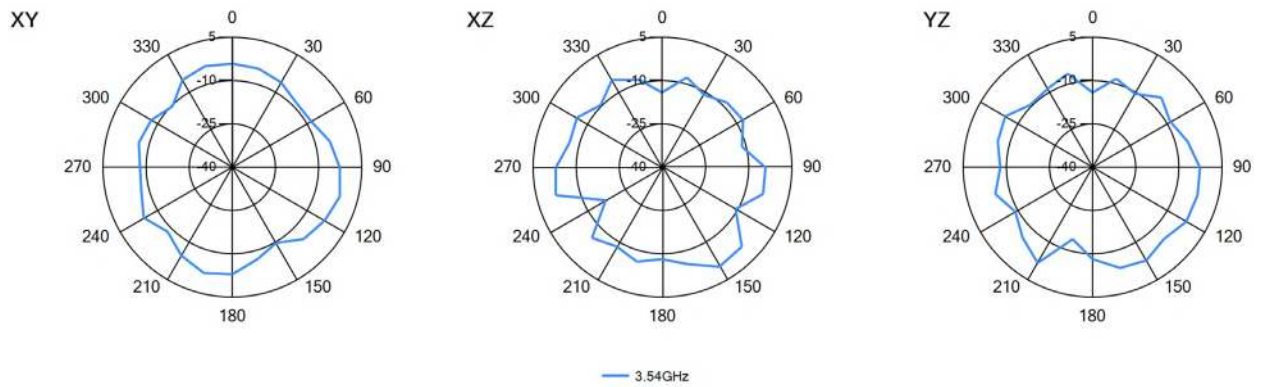

7. Antenna dimensions

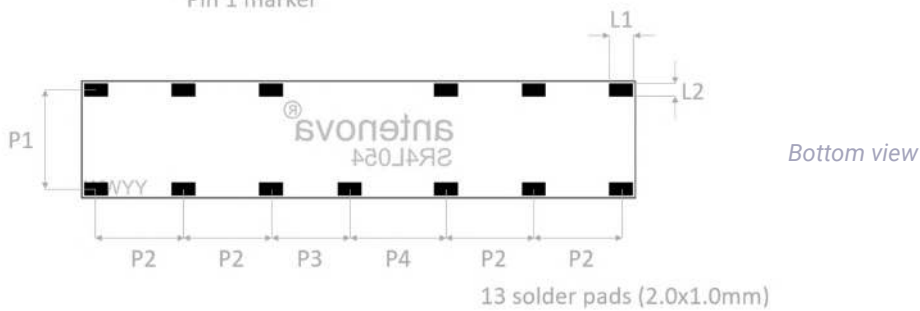

L	W	H
Length	Width	Height
50.6 ± 0.1	10.6 ± 0.1	3.3 ± 0.1

L1	L2	P1	P2	P3	P4
2.0	1.0	9.0	8.0	7.2	9.0

All dimensions in (mm)

8. Schematic symbol and pin definition

The circuit symbol for the antenna is shown below. The antenna has 13 pins with only two as functional. All other pins are for mechanical strength.

PIN	DESCRIPTION
1	Feed
4	Return/GND
2, 3, 5, 6, 7, 8, 9, 10, 11, 12, 13,	Not used (Mechanical only)

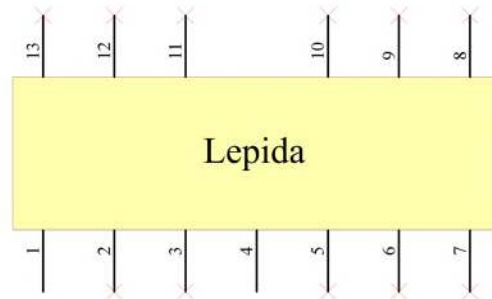

9. Antenna footprint

The recommended host PCB footprint is below.

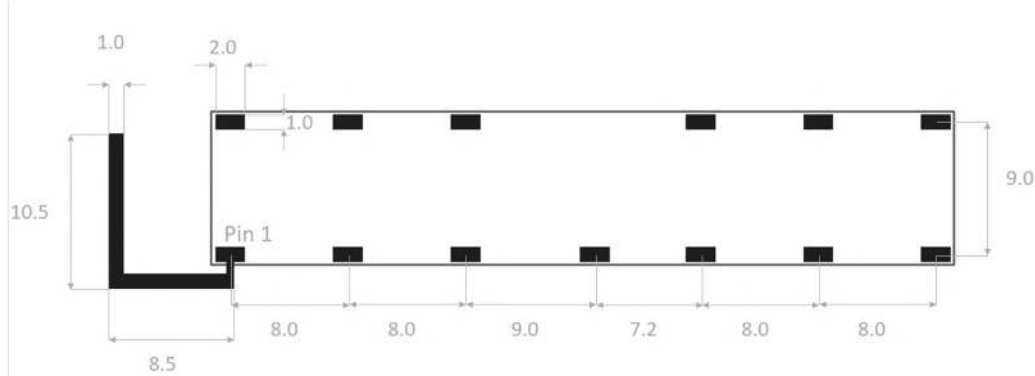

13 copper pads all 2.0 x 1.0 (mm)

10. Electrical interface

10.1. Transmission line

All transmission lines should be designed to have a characteristic impedance of 50Ω.

- The length of the transmission lines should be kept to a minimum
- Any other parts of the RF system like transceivers, power amplifiers, etc, should also be designed to have an impedance of 50 Ω

Once the material for the PCB has been chosen (PCB thickness and dielectric constant), a coplanar transmission line can easily be designed using any of the commercial software packages that are available for transmission line design. For the chosen PCB thickness, copper thickness and substrate dielectric constant, the program will calculate the appropriate transmission line width and gaps on either side of the track so that the characteristic impedance of the co-planar transmission is 50 Ω.

10.2. Matching circuit

The antenna requires a matching circuit that must be optimized for each product. The matching circuit will require up to six components and the following circuit should be designed into the host PCB. Not all components may be required but should be included as a precaution. The matching network should be placed close to the antenna feed to ensure it is optionally effective in tuning the antenna.

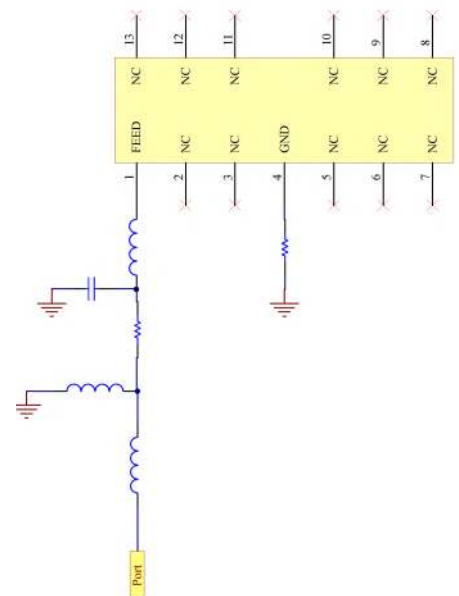

11. Antenna integration guide

11.1. Antenna placement

Whatever size the host PCB is, the antenna should be ideally placed on the host PCB's shortest edge with the longest GND.

Ideally the antenna requires clearance in 5 spatial directions as shown below. Where this cannot be achieved you should keep as many clear as possible and no less than 3. Please note performance will degrade with less clearances.

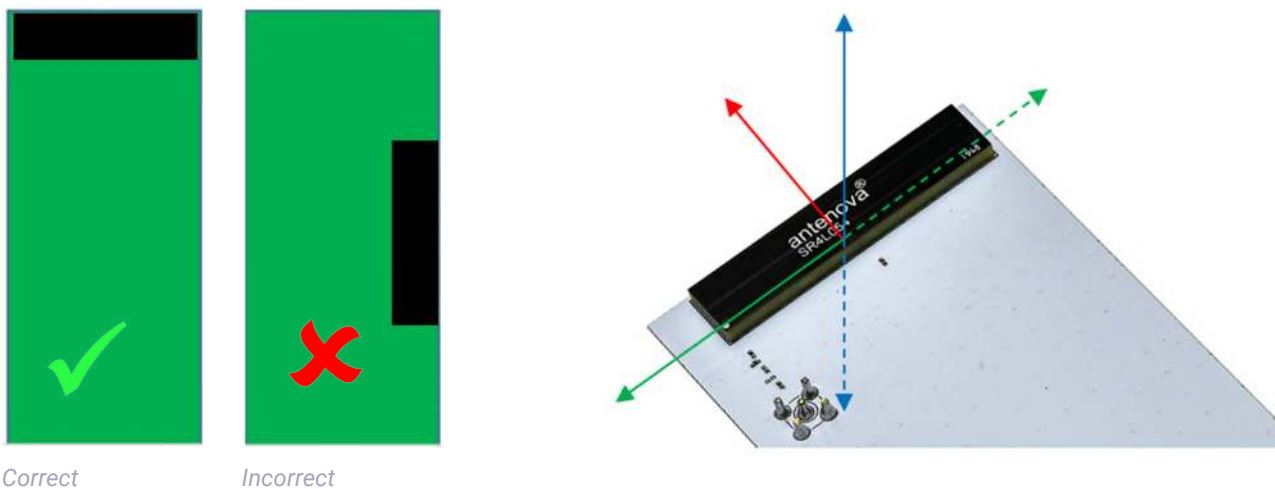

11.2. Host PCB layout

The host PCB must allow that the footprint and clearance meets the antenna specification. This example of a PCB layout shows the antenna footprint with clearance.

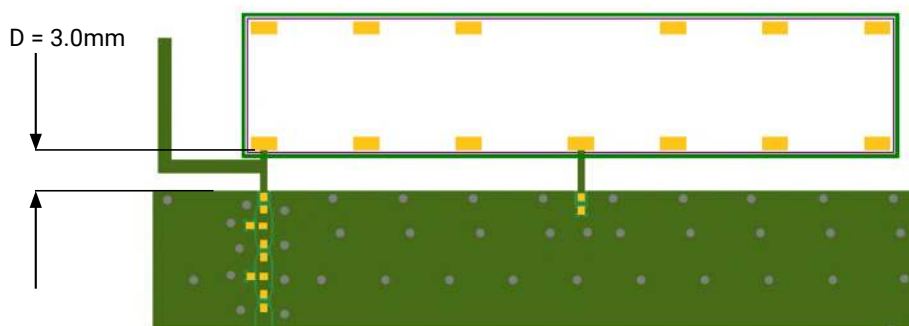

Example host layout

The distance D is the gap required from the antenna SMD pad edge to the ground plane. This should be maintained along the edge the antenna is placed.

11.3. Host PCB clearance

The diagram below shows the antenna footprint and clearance through all layers on the PCB. Only the antenna pads and connections to feed and GND are present within this clearance area.

Placement of components and GND with traces adjacent to the antenna should maintain a minimum clearance of 15mm from either side. The antenna should therefore be placed in the corner to only have one side affected.

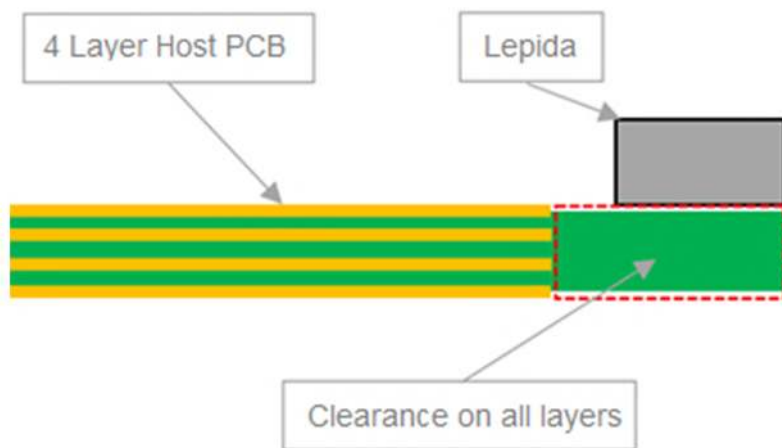

12. Reference board

The reference board has been designed for evaluation purposes of SR4L054 and includes an SMA female connector.

To order a reference board please see antenova.com



12.1. Reference board matching circuit

DESIGNATOR	TYPE	VALUE	DESCRIPTION
C1	Capacitor	0.5pF	Maruta GJM15 series
L2	Inductor	10nH	Murata LQG15HN series
L3	Inductor	1.5nH	Murata LQG15HN series
L1, R1, R2	Resistor	0Ω	Any

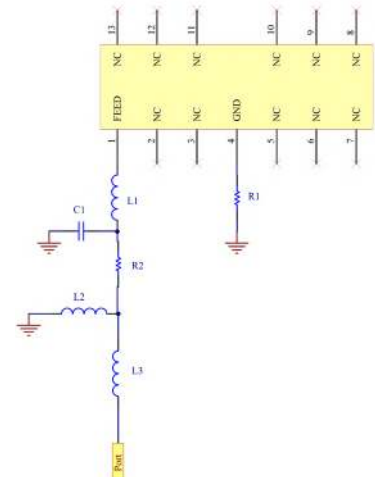

13. Soldering

This antenna is suitable for lead free soldering. The reflow profile should be adjusted to suit the device, oven and solder paste, while observing the following conditions:

- The maximum temperature should not exceed 240 °C
- For lead free soldering, a maximum temperature of 255 °C for no more than 20 seconds is permitted.
- The antenna should not be exposed to temperatures exceeding 120 °C more than 3 times during the soldering process.

14. Hazardous material regulation conformance

The antenna has been tested to conform to RoHS requirements. A certificate of conformance is available from Antenova's website.

15. Packaging

15.1. Optimal storage conditions

TEMPERATURE	-10°C to 40°C
HUMIDITY	Less than 75% RH
SHELF LIFE	24 Months
STORAGE PLACE	Away from corrosive gas and direct sunlight
PACKAGING	Reels should be stored in unopened sealed manufacturer's plastic packaging.

Note: Storage of open reels of antennas is not recommended due to possible oxidization of pads on antennas. If short term storage is necessary, then it is highly recommended that the bag containing the antenna reel is re-sealed and stored in conditions as described in the tabel above.

The shelf life of the antenna is 2 years provided the factory seal on the package has not been broken.

15.2. Tape characteristics

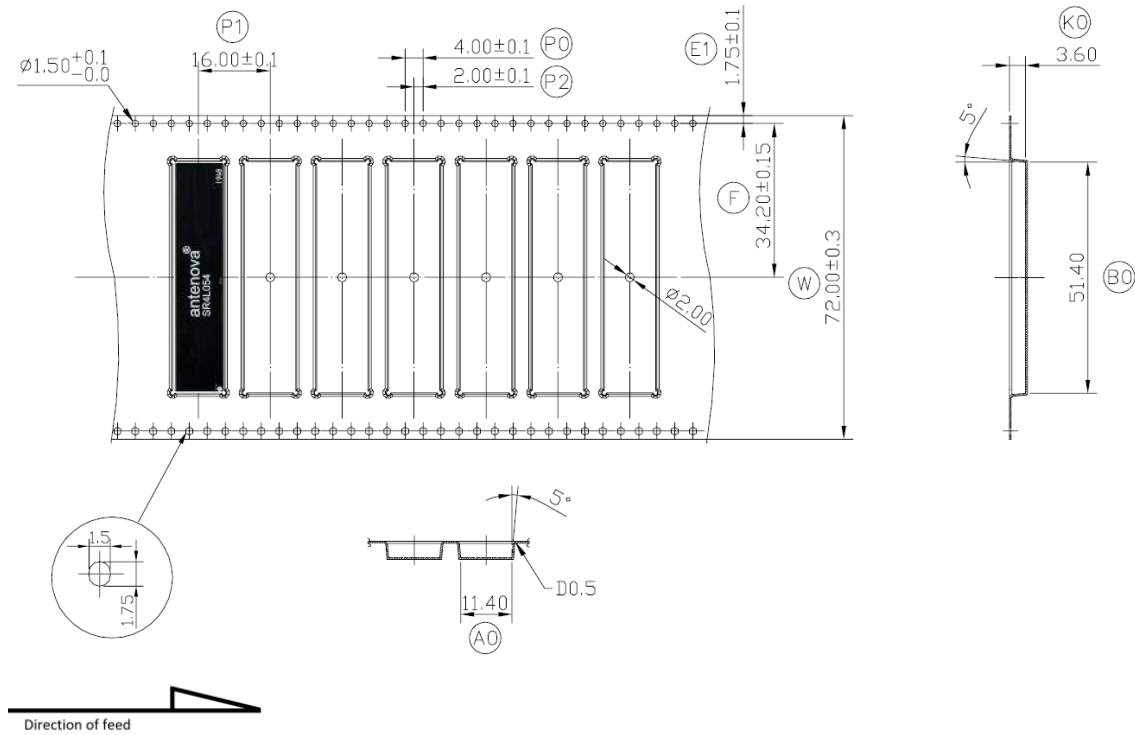

Ko	Ao	Bo	P0	P1	P2
3.60 ± 0.1	11.40 ± 0.1	51.40 ± 0.1	4.00 ± 0.1	16.00 ± 0.1	2.00 ± 0.1

E1	F	W
1.75 ± 0.1	34.20 ± 0.15	72.00 ± 0.3

All dimensions in (mm)

Notes:

1. Material: PS Black – Thickness: 0.40 ± 0.05mm.
2. Packaging length per 22" reel: 53 Meters (1:6).
3. Component load per 13" reel: 500pcs

15.3. Reel dimensions

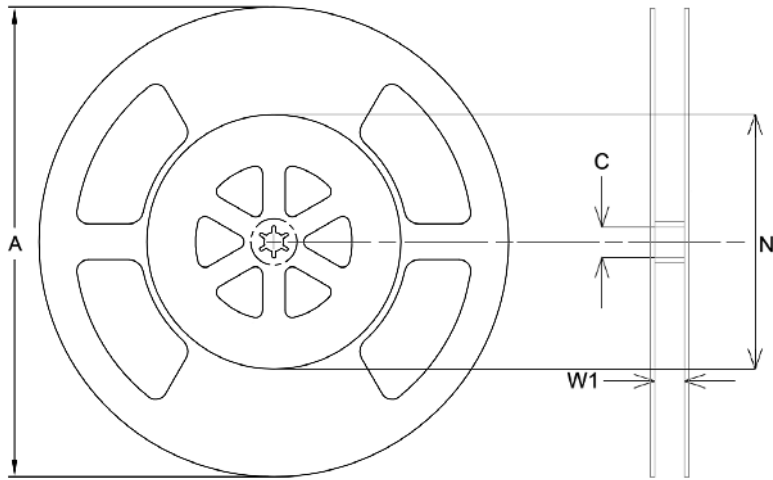

A	C	N	W1
329.0 ± 1.5	13.3 ± 0.5	178.0 ± 1.5	73.0 ± 1.0

All dimensions in (mm)

15.4. Box dimensions

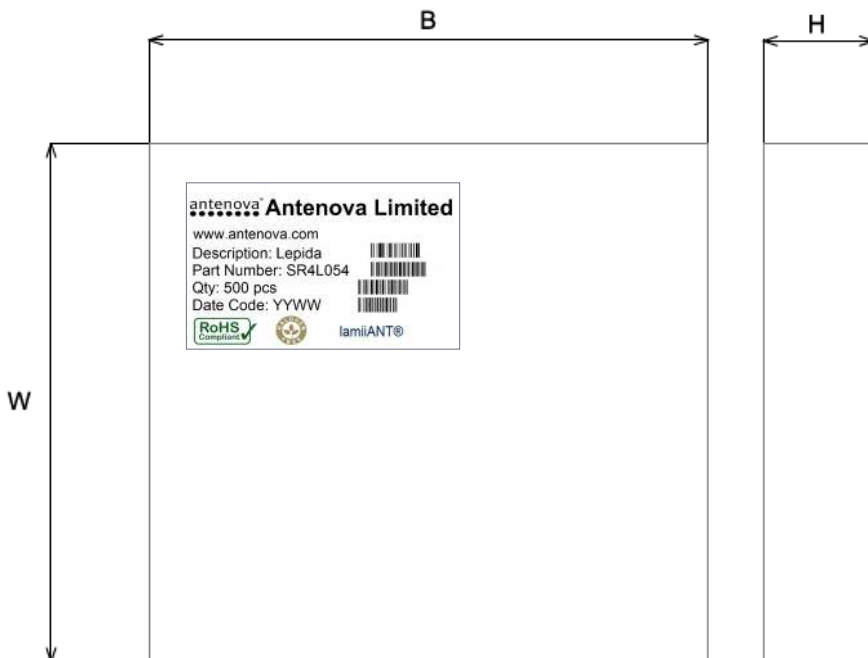

WIDTH (W)	BREADTH (B)	HEIGHT (H)
351mm	349mm	75mm

15.5. Bag properties

Reels are supplied in protective plastic packaging.

15.6. Reel label information



Quality statements

Antenova’s products conform to REACH and RoHS legislation. For our statements regarding these and other quality standards, please see antenova.com.



Antenova reserves all rights to the contents of this document. Antenova gives no warranties based solely on the accuracy or completeness of the contents of this document and reserves the right to make changes to the specifications of the products described herein at any time and without notice.

Antenna design, integration and test resources

Product designers – the details contained in this datasheet will help you to complete your embedded antenna design. Please follow our technical advice carefully to obtain optimum antenna performance.

It is our goal that every one of our customers creates a high performing wireless product using Antenova's antennas. You will find a wealth of design resources, calculators and case studies to aid your design on our website.

Antenova's design laboratories are equipped with the latest antenna design tools and test chambers. We provide antenna design, test and technical integration services to help you complete your design and obtain the required certifications.

If you cannot find the antenna you require in our product range, please contact us to discuss creating a bespoke antenna to meet your requirement exactly.

Share knowledge with **RF experts** around the world.

ask.antenova is a global forum for designers and engineers working with wireless technology.

[VISIT ASK.ANTENOVA](https://ask.antenova.com)

Visit [antenova.com](https://www.antenova.com)

Order antenna samples and evaluation boards, and read our antenna resources

[VISIT ANTENOVA.COM](https://www.antenova.com)

Request a quotation for antennas by volume:

sales@antenova.com

Global headquarters

Antenova Ltd, 2nd Floor Titan Court, 3 Bishop Square, Hatfield, AL10 9NA

+44 (0) 1223 810600