

Z710

8MP Outdoor Mini Dome with D/N, Adaptive IR, Superior WDR, SLLS, Fixed Lens



- 8 Megapixel
- Day & Night with Superior Low Light Sensitivity and Adaptive IR LED
- Fixed Lens with f2.8mm/F2.0
- Superior WDR
- H.265 Compression
- Wide Angle
- Event trigger, response and notification

► Specifications

Device

Product Type	Mini Dome
Maximum Resolution	8MP
Application Environment	Outdoor
Image Sensor	Progressive Scan CMOS
Sensor Size	1/3 "
Day / Night	Yes
Low Light Sensitivity	Superior
Minimum Illumination	Color: 0.05 lux at F2.0 (AGC on); B/W: 0 (IR LED on)
Mechanical IR Cut Filter	Yes
IR LED	Adaptive IR LED (850 nm)
IR Working Distance	40m
Electronic Shutter	1-1/100000 second (manual mode); 1-1/100000 second (auto mode)
S/N Ratio	56 dB

Lens

Focal Length	Fixed focal, f2.8mm
--------------	---------------------

Aperture	F2.0
Iris	Fixed iris
Focus	Fixed focus
Horizontal Viewing Angle	90°
Vertical Viewing Angle	48.7°
Viewing Angle Adjustment	Pan: 0°-360°, Tilt: 0°-68°, Rotation: 0°-360°

Video

Compression	H.265, H.264 (Baseline/ Main profile), MJPEG
Maximum Frame Rate vs. Resolution	20 fps at 3840 x 2160 30 fps at 2944 x 1656 30 fps at 2560 x 1440 30 fps at 1920 x 1080 20 fps at 1280 x 720 20 fps at 704 x 576
Multi-Streaming	Simultaneous triple streams
Wide Dynamic Range	Superior WDR (120 dB)
Image Enhancement	White Balance, Backlight compensation (BLC), Strong Light Suppression, Brightness, Contrast, Saturation, Sharpness, Automatic gain control, Defogging
Digital Noise Reduction	2D + 3D DNR
Privacy Mask	4 configurable regions
Text Overlay	Yes
Built-in Analytics	Tampering Detection
Image Orientation	Flip, Mirror

Network

Network Protocol & Service	IPv4, TCP, UDP, DHCP, HTTP, HTTPS, DNS, DDNS, NTP, RTP, RTSP, RTCP, SMTP, FTP, IGMP, ICMP, ARP, UPnP, SSL, QoS
Ethernet Port	1 x Ethernet (10/100 Base-T), RJ-45 connector

Event

Event Trigger	Video motion detection
Event Response	E-mail notification with snapshots, Upload snapshot to FTP server

Integration

ONVIF Compliant	Yes, Profile S
-----------------	----------------

Interface

Operating Button	No
------------------	----

General

Power Source	DC 12V, PoE (IEEE802.3af)
Weight	384g (0.85lb)
Dimensions	(Ø x H): 109mm x 81mm (4.3" x 3.2")
Environmental Casing	Weatherproof (IP68), Vandal proof (IK10)
Operating Temperature	-35°C ~ 60°C (-31°F ~ 140°F)
Operating Humidity	10% - 95% RH

Approvals

CE Class B, FCC Class B, IP68, IK10

Warranty

2 Year(s). For extended warranty offering, see <http://www.acti.com/support/warranty>

▶ Photo Indication



- 1 DC 12V Power Input
- 2 Ethernet Port



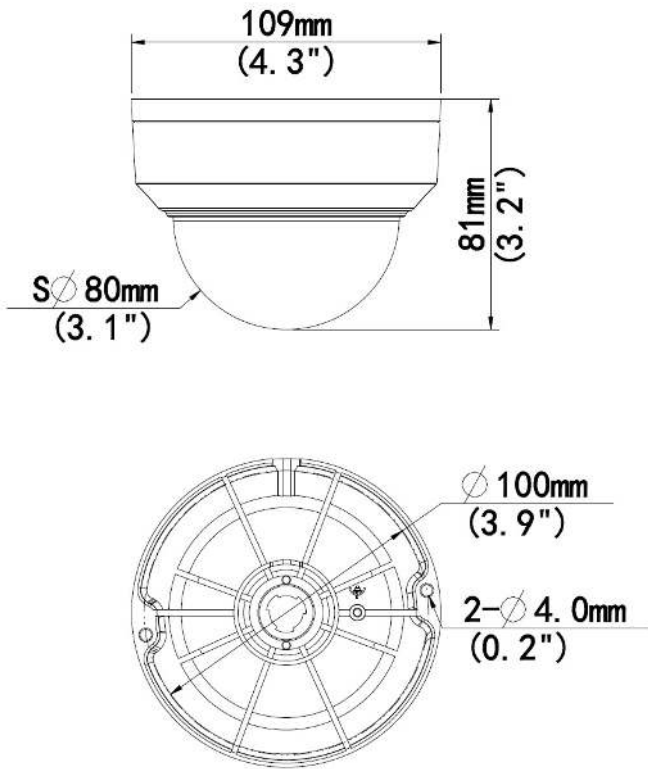









▶ Dimension Diagram



Unit: mm [inch]

► Related Products

Mounting Accessories - Camera Mount



PMAX-0111		Straight Tube (for D5x, D9x, E5x, E9x, E9xx/M)
PMAX-0112		Extension Tube (for D5x, D9x, E5x, E9x, E9xx/M)
PMAX-0122		Straight Tube (for A71, A88, A9x,)
PMAX-0123		Extension Tube (for A71, A88, A9x,)
PMAX-0318		Wall Mount (for A88, A92, A94, A96, Z91, Z94, Z95, Z77, Z710, A61, A62, A71)
PMAX-0323		Wall Mount with Built-in Junction Box (for Z91, Z94, Z95, Z77, Z81, Z82, Z85, Z86)
PMAX-0506		Pole Mount (for A31, A4x, E78, E9x, E9xx), supports 2" to 3" Poles
PMAX-0527		Pole Mount (for Z4x, Z710, Z8x, Z9x, A7x), supports 2.64" to 5" Poles
PMAX-0532		Pole Mount (Z710, Z8x, Z9x, A7x), supports 2.6" to 5" Poles
PMAX-0712		Junction box (for Z91, Z92, Z94, Z95, Z77)
PMAX-0816		Converter Ring, 1.0" NPT for Third-Party Mounting Accessories, White
PMAX-0820		Gang Box Converter (for A71, A74, Z91, Z94, Z95), supports 4" Round and 4" Octagon Boxes
PMAX-1402		Mount Kit (for A91, A92, Z91, A61, A62, A71)

Note: Some mounting accessories may need additional accessories for installation. Please check www.acti.com/mountingselector for more information.

Power Supply Accessories - Power Adapter

PPBX-0012		Power Adapter AC 100~240V (US), for A3x, A4x, A88, A9x, Z31, Z8x, Z9x
PPBX-0013		Power Adapter AC 100~240V (EU), for A3x, A4x, A88, A9x, Z31, Z8x, Z9x
PPBX-0014		Power Adapter AC 100~240V (UK), for A3x, A4x, A88, A9x, Z31, Z8x, Z9x

Power Supply Accessories - PoE Injector

PPOE-0002		PoE Injector IEEE 802.3af compliant, AC 100~240V, with universal connectors
PPOE-0101		High PoE Injector IEEE 802.3at compliant, AC 100~240V, with universal connectors (for A416, A418, B913, B923, B934, Q450, Q75, VMGB-400, VMGB-603, VMGB-604, Z36, Z37, Z71, Z710, Z952)
PPOE-0106		High PoE Injector IEEE 802.3at compliant, AC 100~240V, with universal connectors (for A416, A418, B913, B923, B934, Q450, Q75, VMGB-60X, Z37, Z71, Z952)