

MAXM17710-MAXM17726

Integrated 4V-60V, 100mA, Himalaya uSLIC Power Module DC-DC Converter with 50mA Linear Regulator

General Description

The Himalaya series of voltage-regulator ICs and power modules enable cooler, smaller, and simpler power-supply solutions. The MAXM17710-MAXM17726 family of dual-output regulators integrate a high efficiency 150mA synchronous step-down DC-DC converter and a high power-supply rejection ratio (PSRR), low noise, 50mA linear regulator into uSLIC™ power modules. The modules operate from a wide input voltage range of 4V to 60V. The step-down converter and linear regulator can deliver output currents up to 150mA and 50mA, respectively. MAXM17710-MAXM17714 modules offer fixed 3.3V output from the DC-DC converter. MAXM17715-MAXM17720 modules offer fixed 5V output from the DC-DC converter. MAXM17721-MAXM17726 modules offer adjustable output voltage from the DC-DC converter. The output of the DC-DC converter serves as the input to the linear regulator. The linear regulators offer fixed output voltages between 1.2V and 3.3V in different modules. Refer to the [Ordering Information](#) for a complete list of part numbers. The modules significantly reduce design complexity, manufacturing risks and offer a true plug-and-play power supply solution, reducing time to market.

The modules employ peak current mode control architecture for step-down converters. To reduce input inrush current, the modules offer a fixed soft-start of 5.1ms (typ) for the step-down converter and 1.1ms (typ) for the linear regulator.

The modules are available in a low profile, compact 10-pin (2.6mm x 3mm x 1.5mm) uSLIC package.

Applications

- Industrial Sensors
- Programmable Logic Controller
- Battery-Powered Equipment
- HVAC and Building Control
- LDO Replacement

Benefits and Features

- Easy to Use
 - Wide 4V to 60V Input Step-Down Converter
 - Adjustable and Fixed Output Voltage Modules
 - Internal Inductor and Compensation
 - Up to 150mA Output Current from a Step-Down Converter
 - ±1.3% Accuracy for Linear Regulator Output and ±2% FB Accuracy for Step-Down Converter
 - All Ceramic Capacitors, Compact Layout
 - Built-In 50mA high PSRR Linear Voltage Regulator with Different Output Voltage Options
- High Efficiency
 - Selectable PWM or PFM mode operation
 - PFM Enables Enhanced Light Load Efficiency
 - 2.5µA Shutdown Current
 - 70µA No-Load Supply Current
- Flexible Design
 - Internal Soft-Start and Prebias Startup
 - 350kHz to 2.2MHz Adjustable Switching Frequency with External Synchronization for Step-Down Converters
 - Open-Drain Power-Good Output ($\overline{\text{RESET}}$ Pin)
 - Programmable EN/UVLO Threshold
- Robust Operation
 - Hiccup Overcurrent Protection
 - Overtemperature Protection
 - -40°C to +125°C Ambient Operating Temperature Range/-40°C to +150°C Junction Temperature Range
- Rugged
 - Complies with CISPR22(EN55022) Class B Conducted and Radiated Emissions
 - Passes Drop, Shock, and Vibration Standards: JEESD22-B103, B104, B111

[Ordering Information](#) appears at end of datasheet.

Typical Application Circuit

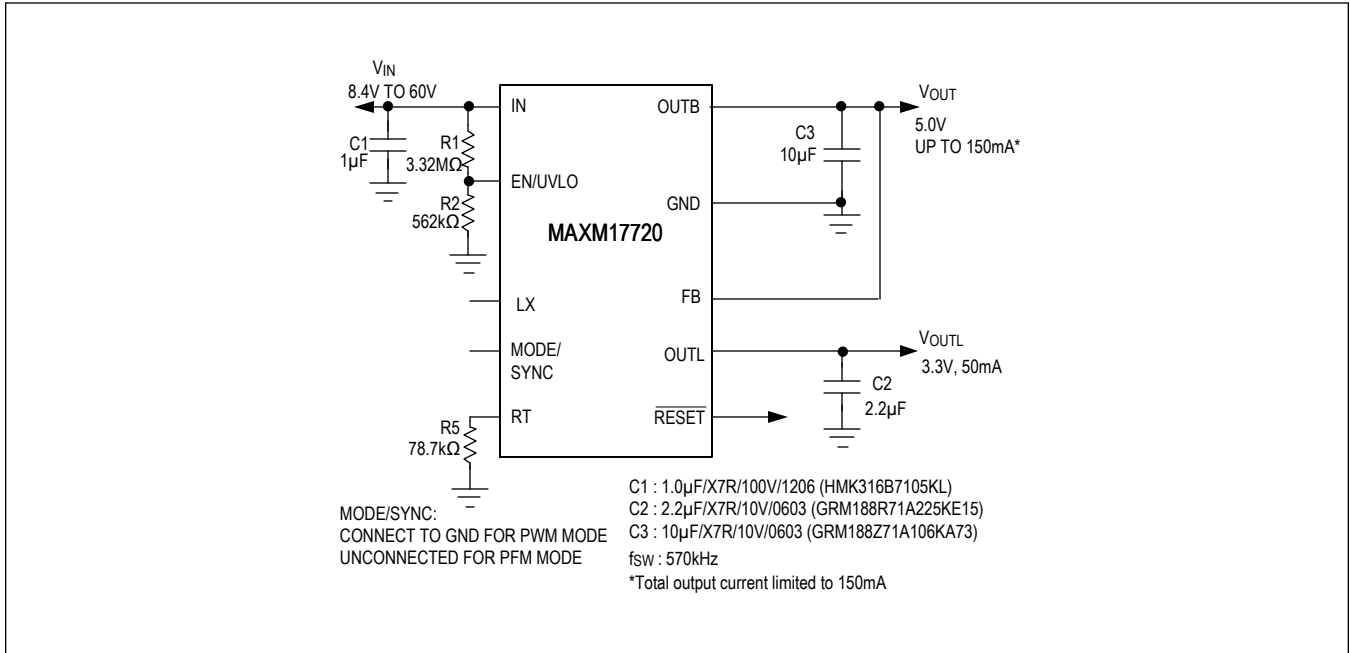

Absolute Maximum Ratings

IN to GND	-0.3V to +70V	FB to GND (adjustable buck output parts)	-0.3V to +6V
LX to GND	-0.3V to IN+0.3V	Output Short-Circuit Duration	Continuous
EN/UVLO to GND	-0.3V to IN+0.3V	Junction Temperature (Note 1)	+150°C
RT, OUTL, MODE/SYNC, RESET to GND	-0.3V to +6V	Storage Temperature Range	-55°C to +125°C
OUTB to GND	-5.5V to lower of (V _{IN} +0.6V) or +6V	Lead Temperature (soldering, 10s)	+260°C
FB to GND (fixed buck output parts)	-5.5V to +6V	Soldering Temperature (reflow)	+260°C

Note 1: Junction temperature greater than +125°C degrades operating lifetimes.

Stresses beyond those listed under "Absolute Maximum Ratings" may cause permanent damage to the device. These are stress ratings only, and functional operation of the device at these or any other conditions beyond those indicated in the operational sections of the specifications is not implied. Exposure to absolute maximum rating conditions for extended periods may affect device reliability.

Package Information

PACKAGE TYPE: 10-PIN uSLIC

Package Code	M102A3+3
Outline Number	21-100094
Land Pattern Number	90-100027
Thermal Resistance, Four-Layer Board (Note 2)	
Junction-to-Ambient (θ_{JA})	45°C/W

For the latest package outline information and land patterns (footprints), go to www.maximintegrated.com/packages. Note that a "+", "#", or "-" in the package code indicates RoHS status only. Package drawings may show a different suffix character, but the drawing pertains to the package regardless of RoHS status.

Note 2: Package thermal resistances is measured on an evaluation board with natural convection.

Electrical Characteristics

(V_{IN} = V_{EN/UVLO} = 24V, V_{OUTB} = 3.3V for MAXM17710-MAXM17714 and 5V for MAXM17715-MAXM17726, V_{FB} = 1.05 × V_{FB-REG}, C_{OUTL} = 2.2μF to GND, V_{GND} = 0V, RT = LX = MODE/SYNC = RESET = unconnected, T_A = -40°C to +125°C, unless otherwise noted. Typical values are at T_A = +25°C. All voltages are referenced to GND, unless otherwise noted.) (Note 3)

PARAMETER	SYMBOL	CONDITIONS	MIN	TYP	MAX	UNITS
INPUT SUPPLY (IN)						
Input Voltage Range	V _{IN}		4		60	V
Input Shutdown Current	I _{IN_SH}	V _{EN/UVLO} = 0V, T _A = +25°C		2.5	4.5	μA
Input Quiescent Current	I _{Q_PFM}			70		μA
	I _{Q_PWM}	V _{FB} = 0.95 × V _{FB-REG} , Normal switching mode, V _{OUTB} > 2.5V		1000		
ENABLE/UVLO (EN/UVLO)						
EN Threshold	V _{ENR}	V _{EN} rising	1.19	1.215	1.24	V
	V _{ENF}	V _{EN} falling	1.068	1.09	1.112	
EN Input Leakage Current	I _{ENLKG}	V _{EN} = 1.3V, T _A = 25°C	-100		+100	nA
BIAS From OUTB						
OUTB Switchover Voltage	V _{OUTB_TH}	OUTB rising	2.725	3	3.21	V
OUTB Switchover Hysteresis	V _{OUTB_HYS}			0.17		V

Electrical Characteristics (continued)

($V_{IN} = V_{EN/UVLO} = 24V$, $V_{OUTB} = 3.3V$ for MAXM17710-MAXM17714 and $5V$ for MAXM17715-MAXM17726, $V_{FB} = 1.05 \times V_{FB-REG}$, $C_{OUTL} = 2.2\mu F$ to GND, $V_{GND} = 0V$, $RT = LX = MODE/SYNC = RESET =$ unconnected, $T_A = -40^\circ C$ to $+125^\circ C$, unless otherwise noted. Typical values are at $T_A = +25^\circ C$. All voltages are referenced to GND, unless otherwise noted.) (Note 3)

PARAMETER	SYMBOL	CONDITIONS	MIN	TYP	MAX	UNITS
SOFT-START						
Soft-Start Time	t_{SS1}		4.4	5.1	5.8	ms
STEP-DOWN CONVERTER FEEDBACK (FB)						
FB Regulation Voltage	V_{FB-REG}	MODE/SYNC = GND, PWM Mode, MAXM17710-MAXM17714	3.216	3.3	3.365	V
		MODE/SYNC = Unconnected, PFM Mode, MAXM17710-MAXM17714	3.216	3.35	3.425	
		MODE/SYNC = GND, PWM Mode, MAXM17715-MAXM17720	4.887	5	5.087	
		MODE/SYNC = Unconnected, PFM Mode, MAXM17715-MAXM17720	4.887	5.075	5.188	
		MODE/SYNC = GND, PWM Mode, MAXM17721-MAXM17726	0.782	0.8	0.814	
		MODE/SYNC = Unconnected, PFM Mode, MAXM17721-MAXM17726	0.782	0.812	0.830	
FB Input Bias Current	I_{FB}	Fixed buck output voltage parts		10		μA
		Adjustable buck output voltage parts, $T_A = 25^\circ C$	-100		+100	nA
OSCILLATOR (RT)						
Switching Frequency Accuracy		$f_{SW} = 350kHz$ to $2.2MHz$	-11		+11	%
Switching Frequency	f_{SW}		536	610	680	kHz
Switching Frequency Adjustable Range			350		2200	kHz
TIMING						
Minimum On-Time	t_{ON_MIN}			75	128	ns
Minimum Off-Time	t_{OFF_MIN}		40	55	80	ns
Minimum Off-Time during SYNC Mode of Operation	$t_{OFF_MIN(SYN C)}$		48	75	100	ns
HICCUP Timeout				51		ms
MODE/SYNC						
MODE/SYNC Internal Pullup Resistor	R_{MODE}	Mode = PFM		32		k Ω
		Mode = PWM		1100		
SYNC Input Frequency			$1.1 \times f_{SW}$		$1.4 \times f_{SW}$	
Minimum SYNC Pulse Width			100			ns
SYNC Threshold	V_{IH}		2.1			V
	V_{IL}				0.8	

Electrical Characteristics (continued)

($V_{IN} = V_{EN/UVLO} = 24V$, $V_{OUTB} = 3.3V$ for MAXM17710-MAXM17714 and $5V$ for MAXM17715-MAXM17726, $V_{FB} = 1.05 \times V_{FB-REG}$, $C_{OUTL} = 2.2\mu F$ to GND, $V_{GND} = 0V$, $RT = LX = MODE/SYNC = RESET =$ unconnected, $T_A = -40^\circ C$ to $+125^\circ C$, unless otherwise noted. Typical values are at $T_A = +25^\circ C$. All voltages are referenced to GND, unless otherwise noted.) (Note 3)

PARAMETER	SYMBOL	CONDITIONS	MIN	TYP	MAX	UNITS
RESET						
RESET Output Level Low		$I_{\overline{RESET}} = 10mA$			400	mV
RESET Output Leakage Current		$T_A = +25^\circ C$, $V_{\overline{RESET}} = 5.5V$	-100		100	nA
Maximum Sink Current into RESET					10	mA
FB Threshold for RESET Rising	V_{FBR}	FB rising	92	95	98	%
FB Threshold for RESET Falling	V_{FBF}	FB falling	89	92	95	%
OUTL Threshold for RESET Rising	V_{OUTLR}	OUTL rising	91.5	94.5	97.5	%
OUTL Threshold for RESET Falling	V_{OUTLF}	OUTL falling	88	91	94	%
RESET Delay After FB and VOUTL Reach 95% Regulation	t_D			2.1		ms
LINEAR REGULATOR INPUT SUPPLY						
Linear Regulator Input Voltage Range	V_{OUTB}		2.35		5	V
Linear Regulator UVLO	V_{OUTB_UVLO}		2.11	2.18	2.25	V
Linear Regulator UVLO Hysteresis	$V_{OUTB_UVLO}(HYS)$			50		mV
LINEAR REGULATOR OUTPUT VOLTAGE (OUTL)						
OUTL Accuracy		$I_{OUTL} = 10mA$, $V_{OUTL} = 1.2V, 1.5V, 1.8V$	-1.5		+1.5	%
		$I_{OUTL} = 10mA$, $V_{OUTL} = 2.5V, 3.0V, 3.3V$	-1.33		+1.33	
Load Regulation		$0.1mA < I_{OUTL} < 50mA$		0.5	0.9	%
Dropout Voltage	V_{DO}	$V_{OUTB} = 100\%$ of nominal value of V_{OUTL} $I_{OUTL} = 50mA$ (Note 4)		200	450	mV
Linear Regulator Current Limit	$I_{LDO-LIM}$		55	84		mA
Soft-Start Time	t_{ss2}			1.1		ms
THERMAL SHUTDOWN						
Thermal-Shutdown Threshold		Temperature rising		160		$^\circ C$
Thermal-Shutdown Hysteresis				20		$^\circ C$

Note 3: All the Electrical Specifications are 100% production tested at $T_A = +25^\circ C$. Specifications over the operating temperature range and relevant supply voltage range are guaranteed by design and characterization.

Note 4: Applicable for linear regulators with nominal output voltages of 2.5V, 3.0V, and 3.3V.

Typical Operating Characteristics

($V_{IN} = V_{EN}/UV_{LO} = 24V$, $V_{GND} = 0V$, $T_A = -40^{\circ}C$ to $+125^{\circ}C$, unless otherwise noted. Typical values are at $T_A = +25^{\circ}C$. All voltages are referenced to GND, unless otherwise noted. The circuit values for different output voltage applications are as in [Table 1](#), unless otherwise noted.)

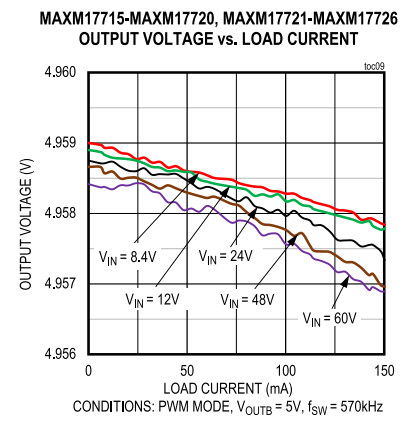
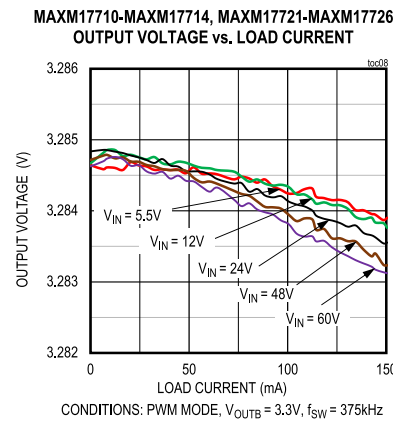
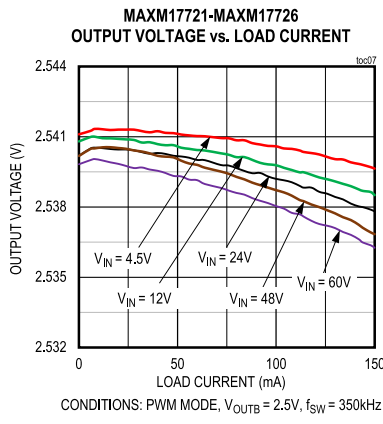
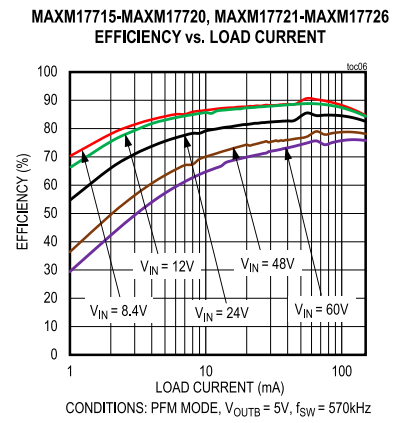
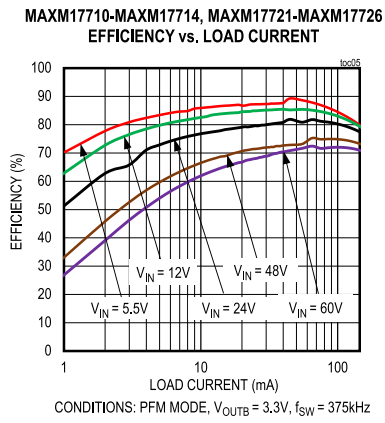
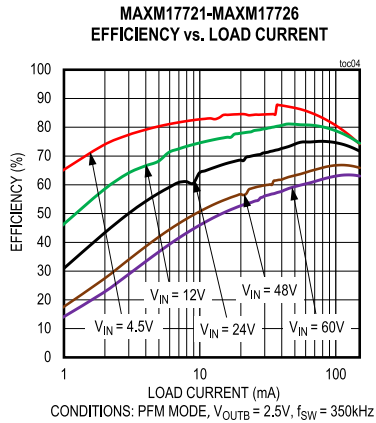
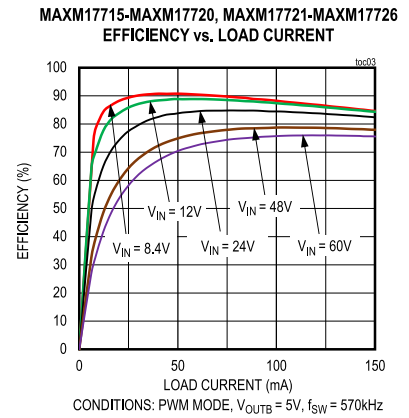
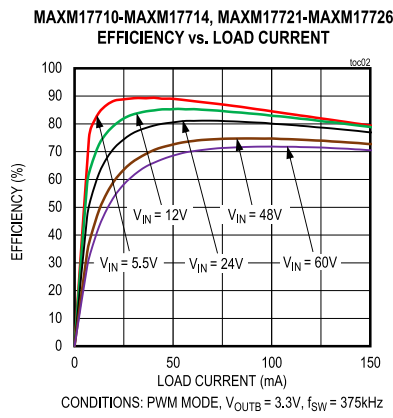
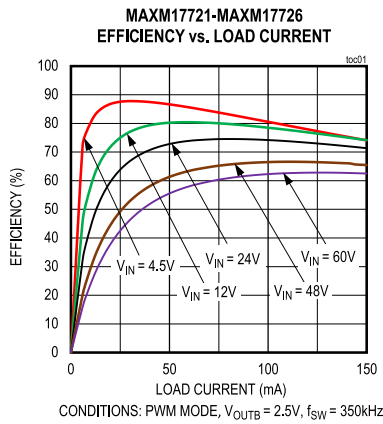

Typical Operating Characteristics (continued)

($V_{IN} = V_{EN}/UV_{LO} = 24V$, $V_{GND} = 0V$, $T_A = -40^{\circ}C$ to $+125^{\circ}C$, unless otherwise noted. Typical values are at $T_A = +25^{\circ}C$. All voltages are referenced to GND, unless otherwise noted. The circuit values for different output voltage applications are as in [Table 1](#), unless otherwise noted.)

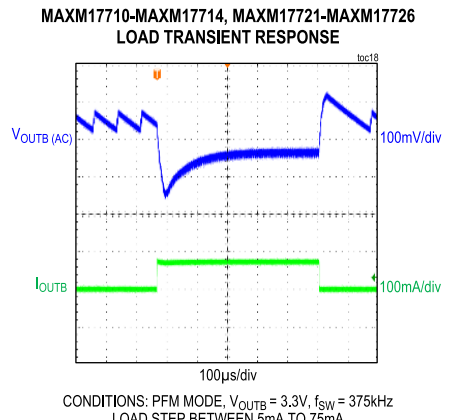
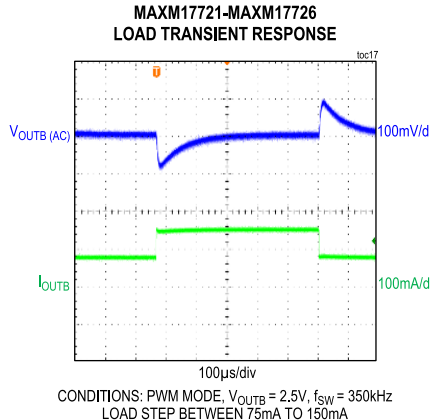
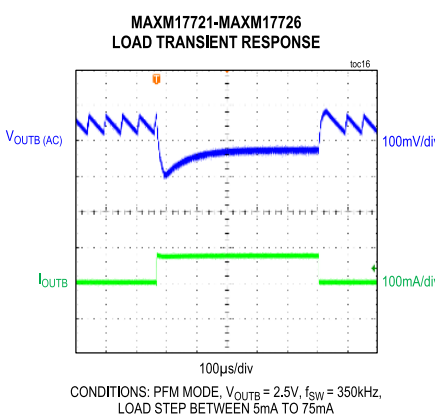
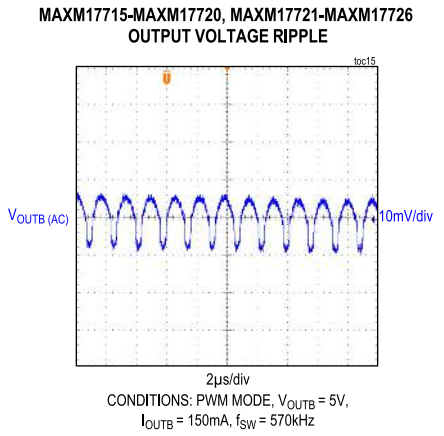
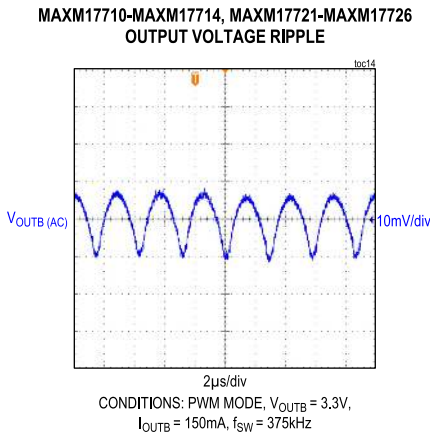
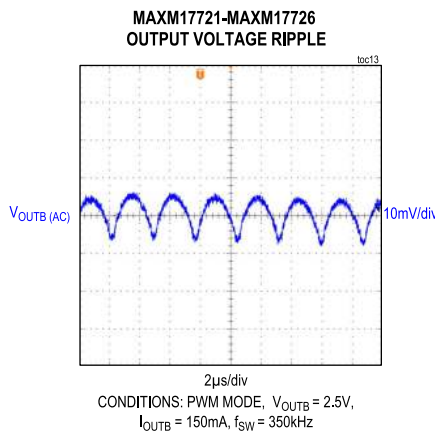
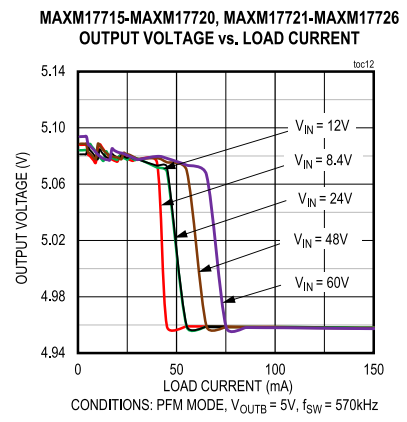
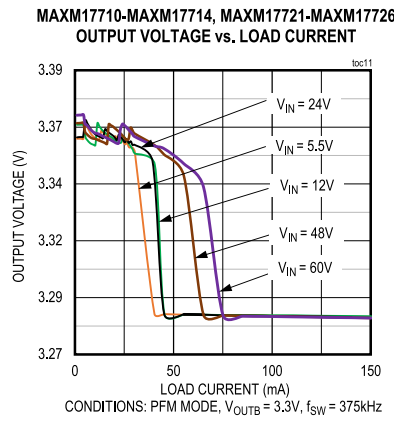
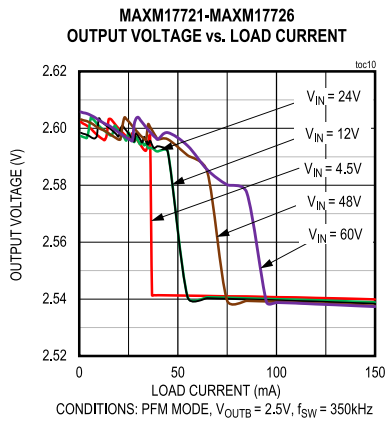

Typical Operating Characteristics (continued)

($V_{IN} = V_{EN/UVLO} = 24V$, $V_{GND} = 0V$, $T_A = -40^{\circ}C$ to $+125^{\circ}C$, unless otherwise noted. Typical values are at $T_A = +25^{\circ}C$. All voltages are referenced to GND, unless otherwise noted. The circuit values for different output voltage applications are as in [Table 1](#), unless otherwise noted.)

MAXM17710-MAXM17714, MAXM17721-MAXM17726
LOAD TRANSIENT RESPONSE

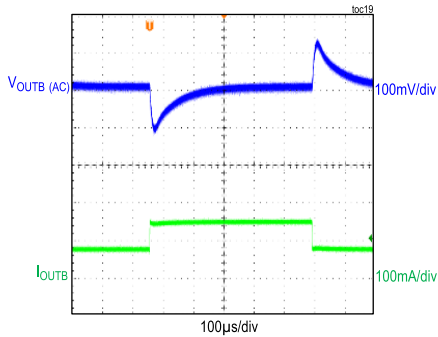

CONDITIONS: PWM MODE, $V_{OUTB} = 3.3V$, $f_{SW} = 375kHz$
LOAD STEP BETWEEN 75mA TO 150mA

MAXM17715-MAXM17720, MAXM17721-MAXM17726
LOAD TRANSIENT RESPONSE

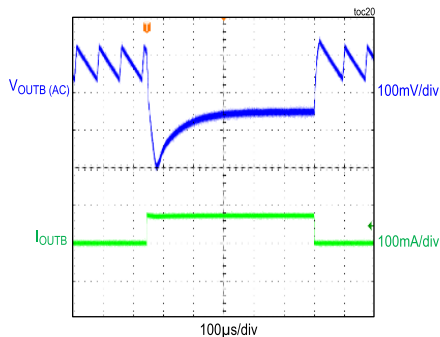

CONDITIONS: PFM MODE, $V_{OUTB} = 5V$, $f_{SW} = 570kHz$
LOAD STEP BETWEEN 5mA TO 75mA

MAXM17715-MAXM17720, MAXM17721-MAXM17726
LOAD TRANSIENT RESPONSE

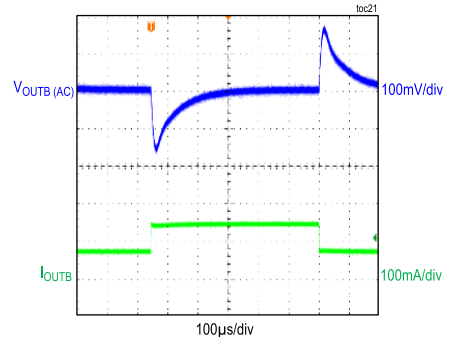

CONDITIONS: PWM MODE, $V_{OUTB} = 5V$, $f_{SW} = 570kHz$
LOAD STEP BETWEEN 75mA TO 150mA

MAXM17724
STARTUP THROUGH ENABLE

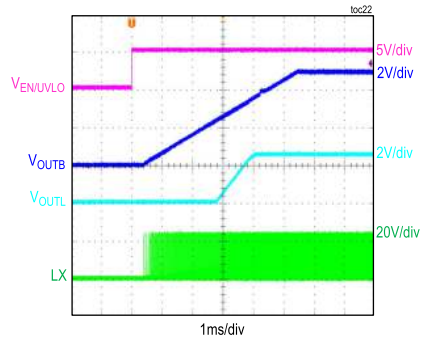

CONDITIONS: PWM MODE, $V_{OUTB} = 5V$, $V_{OUTL} = 2.5V$,
 $I_{OUTB} = 100mA$, $I_{OUTL} = 50mA$, $f_{SW} = 570kHz$

MAXM17724
SHUTDOWN THROUGH ENABLE

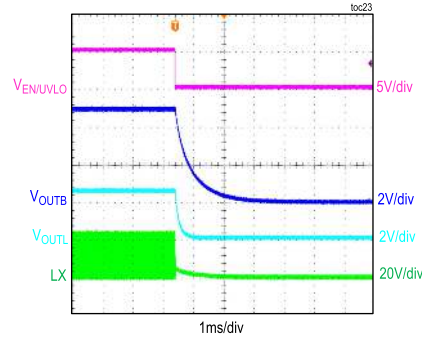

CONDITIONS: PWM MODE, $V_{OUTB} = 5V$, $V_{OUTL} = 2.5V$,
 $I_{OUTB} = 100mA$, $I_{OUTL} = 50mA$, $f_{SW} = 570kHz$

MAXM17724
STARTUP THROUGH ENABLE (1.5V PREBIAS)

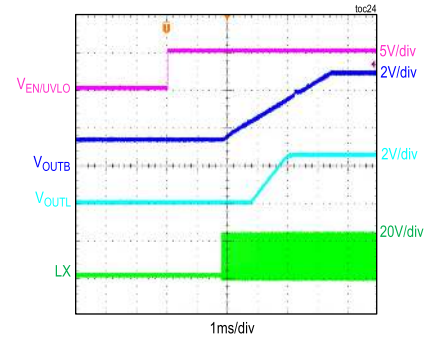

CONDITIONS: PWM MODE, $V_{OUTB} = 5V$, $V_{OUTL} = 2.5V$,
NO LOAD, $f_{SW} = 570kHz$

MAXM17724
STARTUP THROUGH ENABLE (1.5V PREBIAS)

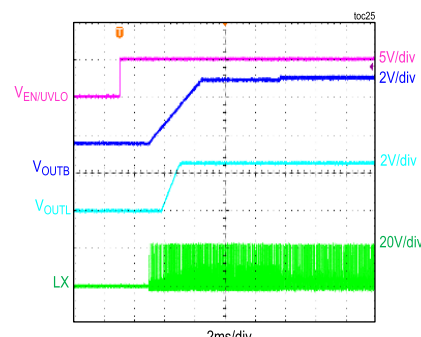

CONDITIONS: PFM MODE, $V_{OUTB} = 5V$, $V_{OUTL} = 2.5V$,
NO LOAD, $f_{SW} = 570kHz$

MAXM17712
STARTUP THROUGH ENABLE

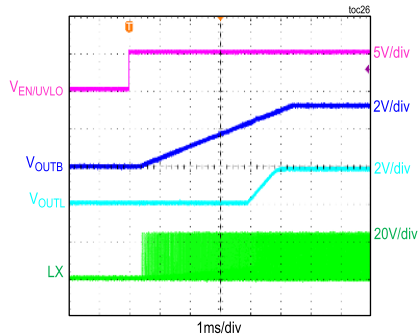

CONDITIONS: PWM MODE, $V_{OUTB} = 3.3V$, $V_{OUTL} = 1.8V$,
 $I_{OUTB} = 100mA$, $I_{OUTL} = 50mA$, $f_{SW} = 375kHz$

MAXM17712
SHUTDOWN THROUGH ENABLE

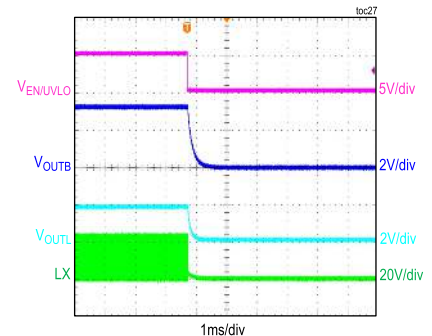

CONDITIONS: PWM MODE, $V_{OUTB} = 3.3V$, $V_{OUTL} = 1.8V$,
 $I_{OUTB} = 100mA$, $I_{OUTL} = 50mA$, $f_{SW} = 375kHz$

Typical Operating Characteristics (continued)

($V_{IN} = V_{EN/UVLO} = 24V$, $V_{GND} = 0V$, $T_A = -40^{\circ}C$ to $+125^{\circ}C$, unless otherwise noted. Typical values are at $T_A = +25^{\circ}C$. All voltages are referenced to GND, unless otherwise noted. The circuit values for different output voltage applications are as in Table 1, unless otherwise noted.)

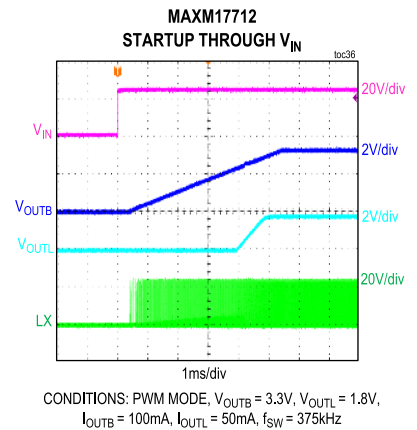
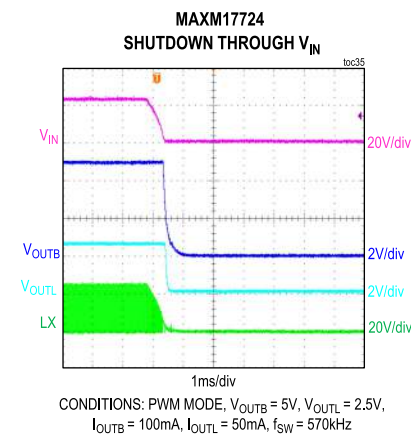
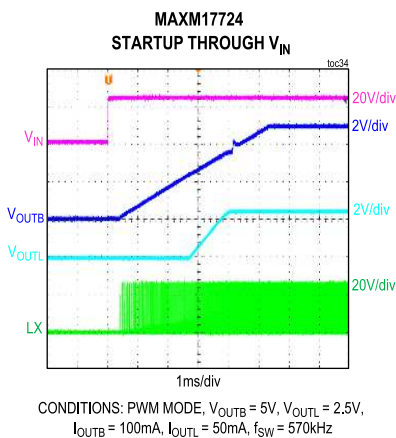
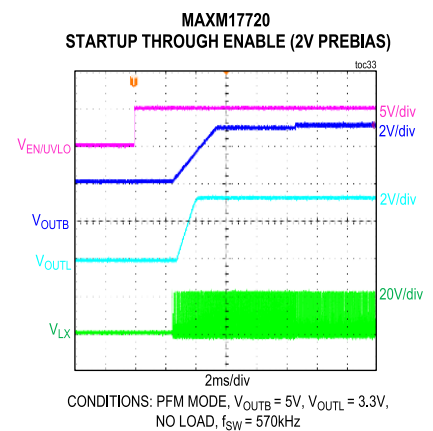
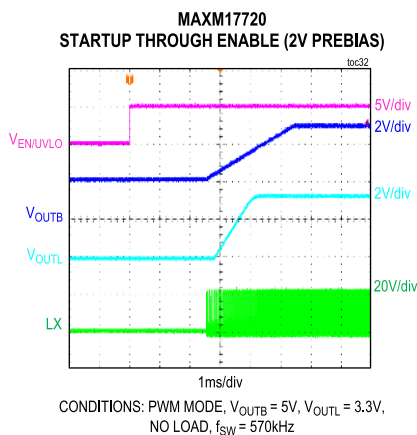
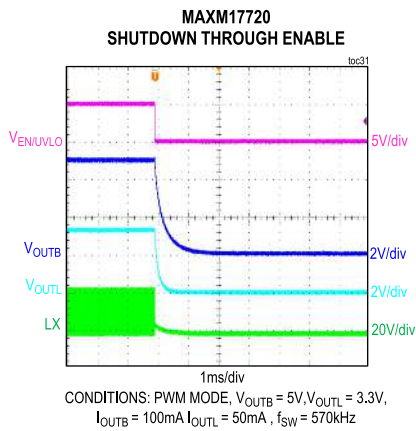
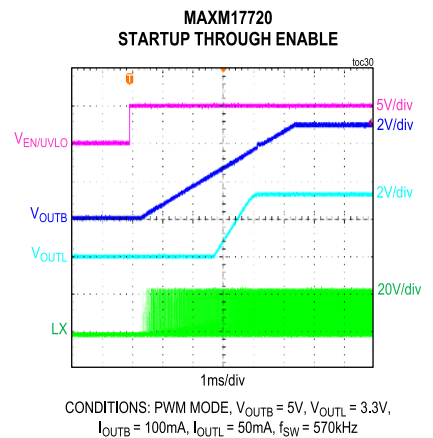
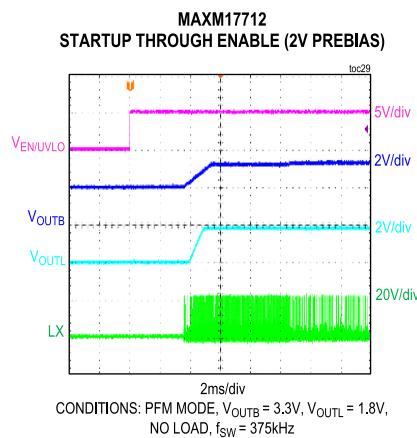
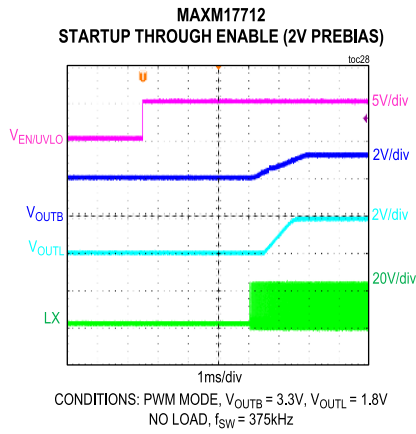

Typical Operating Characteristics (continued)

($V_{IN} = V_{EN}/UVLO = 24V$, $V_{GND} = 0V$, $T_A = -40^{\circ}C$ to $+125^{\circ}C$, unless otherwise noted. Typical values are at $T_A = +25^{\circ}C$. All voltages are referenced to GND, unless otherwise noted. The circuit values for different output voltage applications are as in Table 1, unless otherwise noted.)

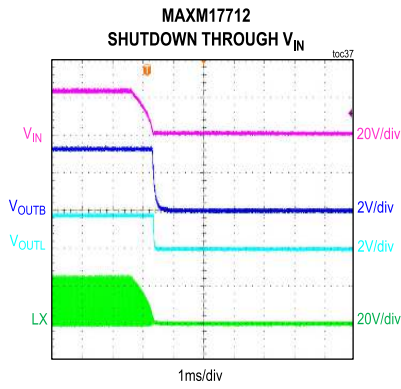

CONDITIONS: PWM MODE, $V_{OUTB} = 3.3V$, $V_{OUTL} = 1.8V$, $I_{OUTB} = 100mA$, $I_{OUTL} = 50mA$, $f_{SW} = 375kHz$

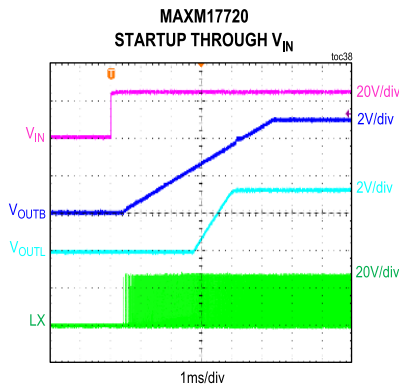

CONDITIONS: PWM MODE, $V_{OUTB} = 5V$, $V_{OUTL} = 3.3V$, $I_{OUTB} = 100mA$, $I_{OUTL} = 50mA$, $f_{SW} = 570kHz$

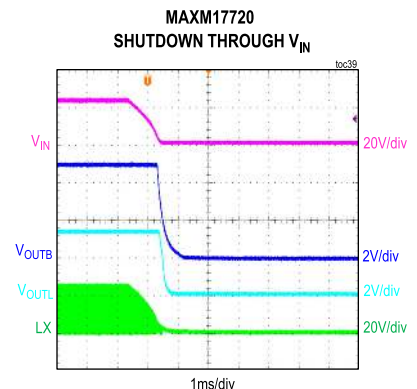

CONDITIONS: PWM MODE, $V_{OUTB} = 5V$, $V_{OUTL} = 3.3V$, $I_{OUTB} = 100mA$, $I_{OUTL} = 50mA$, $f_{SW} = 570kHz$

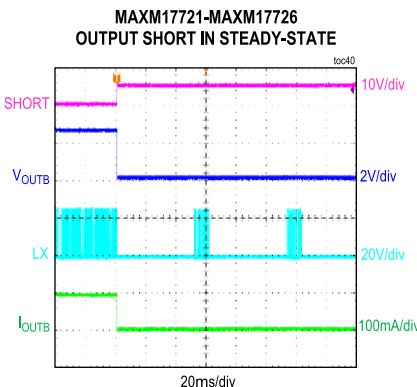

CONDITIONS: PWM MODE, $V_{OUTB} = 2.5V$, $I_{OUTB} = 100mA$, $I_{OUTL} = 50mA$, $f_{SW} = 350kHz$

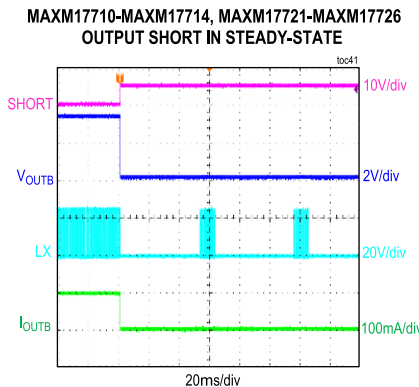

CONDITIONS: PWM MODE, $V_{OUTB} = 3.3V$, $I_{OUTB} = 100mA$, $I_{OUTL} = 50mA$, $f_{SW} = 375kHz$

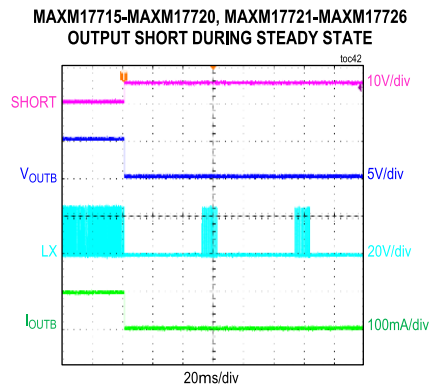

CONDITIONS: PWM MODE, $V_{OUTB} = 5V$, $I_{OUTB} = 100mA$, $I_{OUTL} = 50mA$, $f_{SW} = 570kHz$

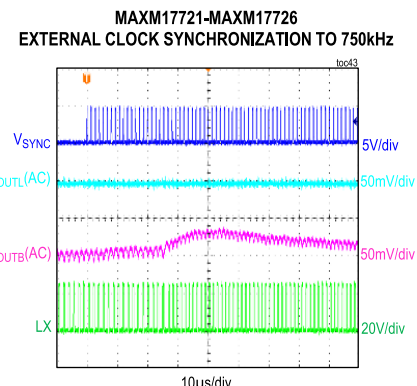

CONDITIONS: PWM MODE, $V_{OUTB} = 5V$, $I_{OUTB} = 100mA$, $I_{OUTL} = 50mA$, $f_{SW} = 570kHz$

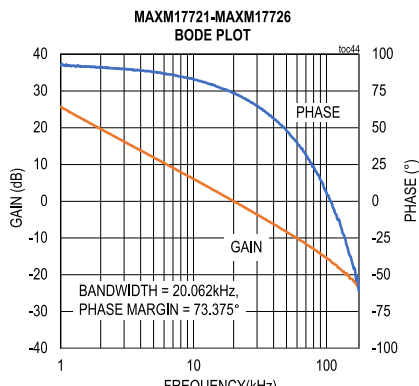

CONDITIONS: PWM MODE, $V_{OUTB} = 2.5V$, $I_{OUTB} = 150mA$, $f_{SW} = 350kHz$

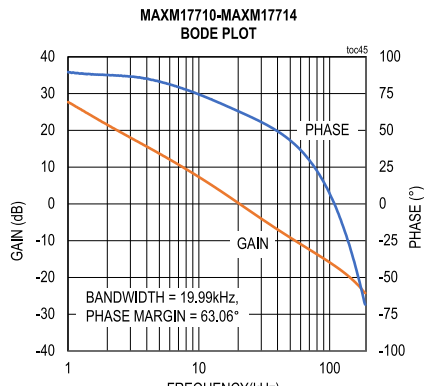

CONDITIONS: PWM MODE, $V_{OUTB} = 3.3V$, $I_{OUTB} = 150mA$, $f_{SW} = 375kHz$

Typical Operating Characteristics (continued)

($V_{IN} = V_{EN}/UV_{LO} = 24V$, $V_{GND} = 0V$, $T_A = -40^{\circ}C$ to $+125^{\circ}C$, unless otherwise noted. Typical values are at $T_A = +25^{\circ}C$. All voltages are referenced to GND, unless otherwise noted. The circuit values for different output voltage applications are as in Table 1, unless otherwise noted.)

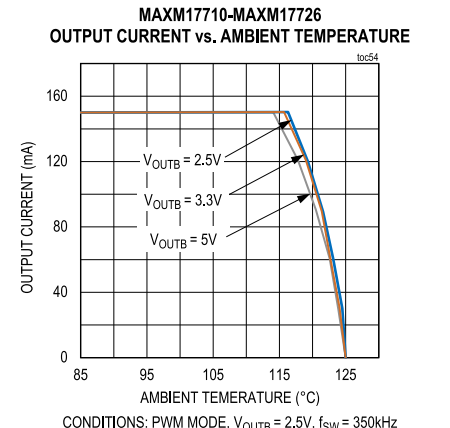
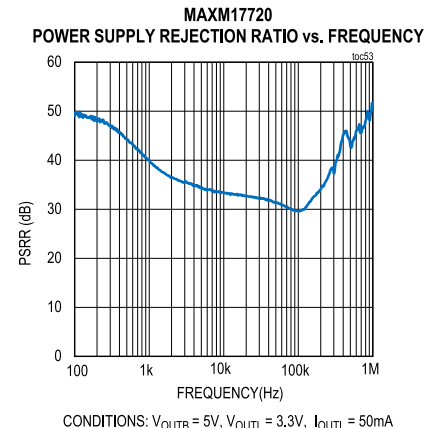
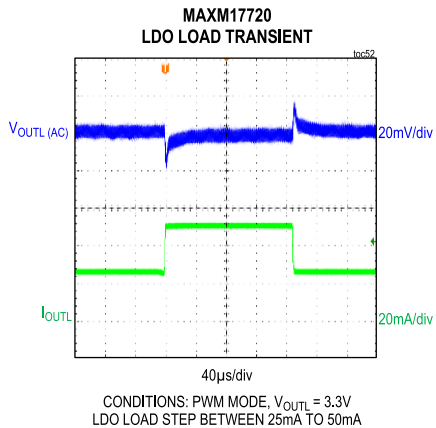
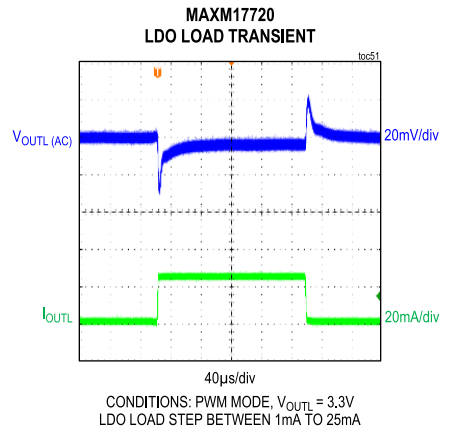
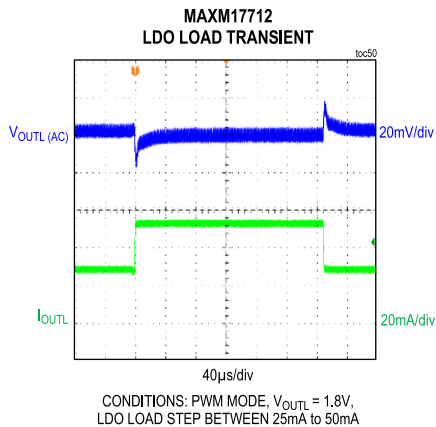
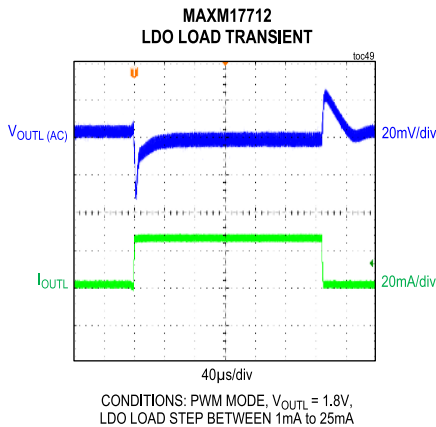
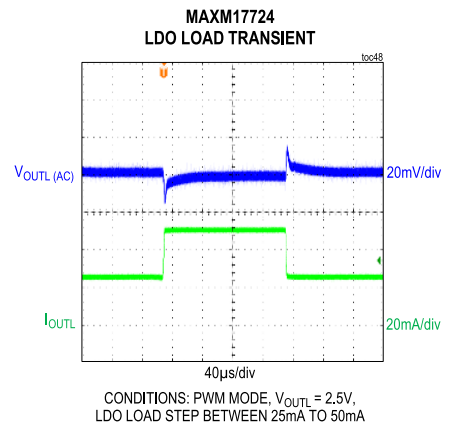
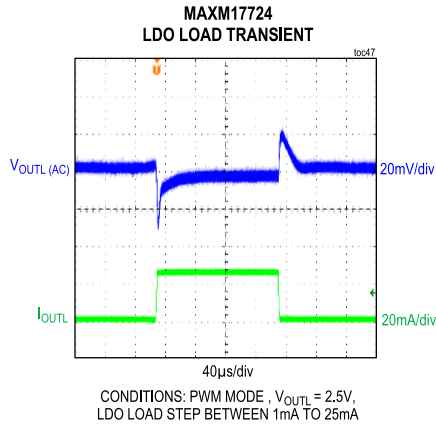
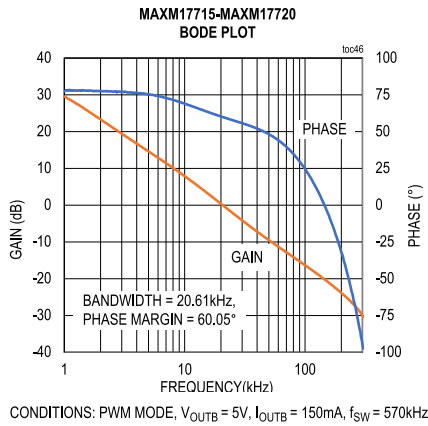

Typical Operating Characteristics (continued)

($V_{IN} = V_{EN}/UVLO = 24V$, $V_{GND} = 0V$, $T_A = -40^{\circ}C$ to $+125^{\circ}C$, unless otherwise noted. Typical values are at $T_A = +25^{\circ}C$. All voltages are referenced to GND, unless otherwise noted. The circuit values for different output voltage applications are as in Table 1, unless otherwise noted.)

MAXM17712 CONDUCTED EMISSIONS PLOT
WITH FILTER $L_{EMI_1} = 82\mu H$, $C_{EMI_1} = 0.47\mu F$, $C_{EMI_2} = 1\mu F$

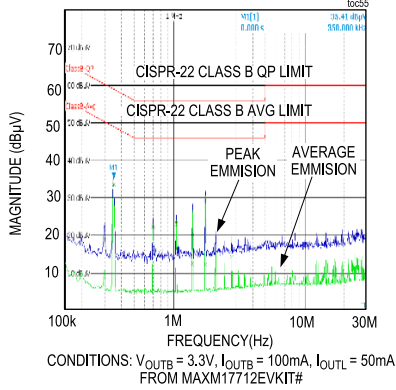

MAXM17712 RADIATED EMISSIONS PLOT
 $L_{EMI_1} = \text{SHORT}$, $C_{EMI_1} = C_{EMI_2} = \text{OPEN}$

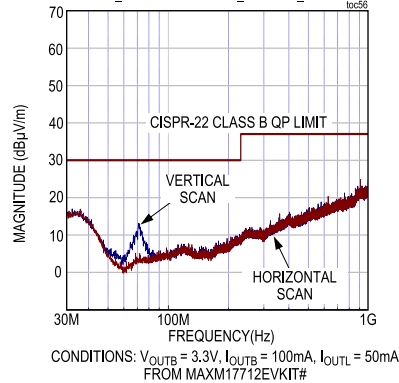

MAXM17720 CONDUCTED EMISSIONS PLOT
WITH FILTER $L_{EMI_1} = 82\mu H$, $C_{EMI_1} = 0.47\mu F$, $C_{EMI_2} = 1\mu F$

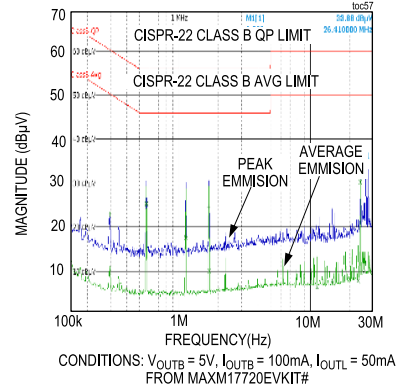

MAXM17720 RADIATED EMISSIONS PLOT
 $L_{EMI_1} = \text{SHORT}$, $C_{EMI_1} = C_{EMI_2} = \text{OPEN}$

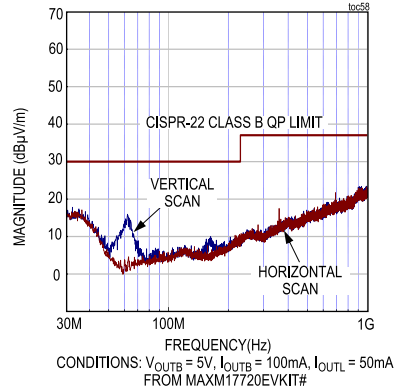

Pin Configuration

MAXM17710-MAXM17726

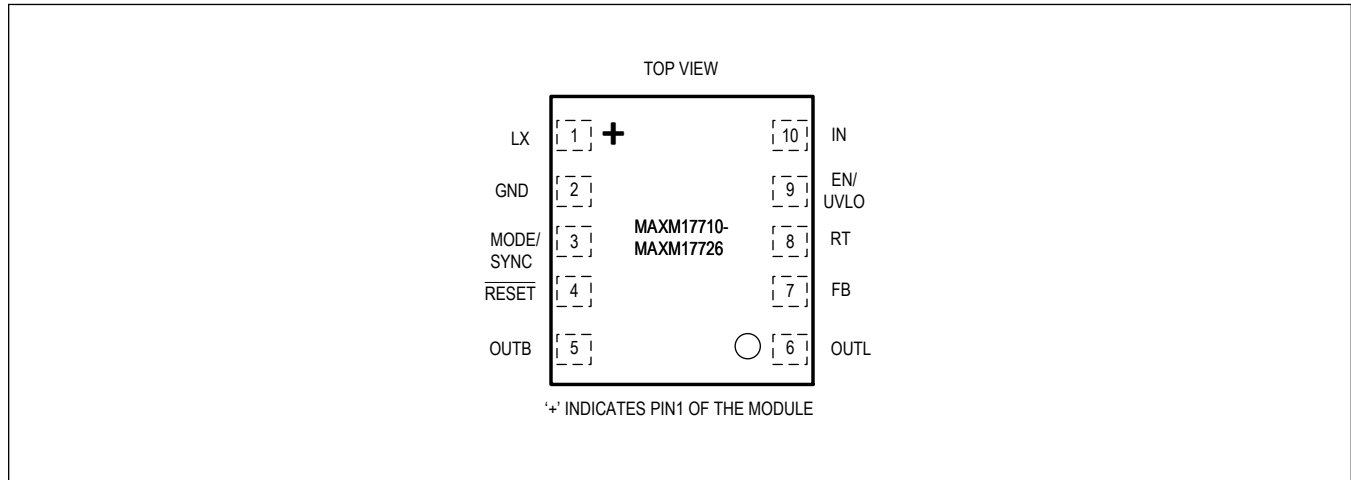

Pin Description

PIN	NAME	FUNCTION
1	LX	Switching Node. Do not connect any external components to the LX pin.
2	GND	Ground. Connect GND to the power ground plane. Connect all the circuit ground connections together at a single point. See the PCB Layout Guidelines section.
3	MODE/SYNC	Mode Selection and External Clock Synchronization Input. Connect the MODE/SYNC pin to the GND pin to enable fixed-frequency PWM operation. Leave MODE/SYNC unconnected for PFM operation. An external clock can be applied to the MODE/SYNC pin to synchronize the internal clock to the external clock. See the Mode Selection and External Clock Synchronization (MODE/SYNC) section for details.
4	RESET	Open-Drain Power-Good Output. Pull up RESET to an external power supply with a resistor. The RESET pin is driven low if FB voltage falls below 92% or OUTL voltage falls below 91.5% of their set value and also when EN/UVLO voltage falls below its threshold value. RESET goes high 2.1ms after FB and OUTL voltages rise above 95% of their set value. RESET functionality is not available in PFM mode of operation.
5	OUTB	Step-Down DC-DC Converter Output Pin. Connect a capacitor from OUTB to GND. This pin is also a linear regulator power-supply input.
6	OUTL	Linear Regulator Output Pin. Connect at least a 2.2µF capacitor across OUTL and GND.
7	FB	Step-Down Converter Feedback Input. For fixed step-down converter output voltage parts, connect FB directly to the output node of the step-down converter. For adjustable step-down converter output voltage parts, connect FB to a resistor-divider between the regulated buck-voltage node and GND. See the Output Voltage Setting section for details.
8	RT	Programmable Switching Frequency Input. Connect a resistor from RT to GND to program the switching frequency from 350kHz to 2.2MHz. Leave the RT pin unconnected for a default 610kHz switching frequency. See the Switching Frequency (RT) section for details.
9	EN/UVLO	Enable/Undervoltage Lockout Input. Drive EN/UVLO high to enable the output voltage. Connect to the midpoint of a resistor divider from IN to GND to set the input voltage at which the device turns on. Pull low to GND to disable the device. See the Setting the Input Undervoltage-Lockout Level section for details.
10	IN	Power Supply Input of the Step-Down Converter. Decouple the IN pin to GND with an X7R 1µF ceramic capacitor.

Functional Diagrams

Block Diagram

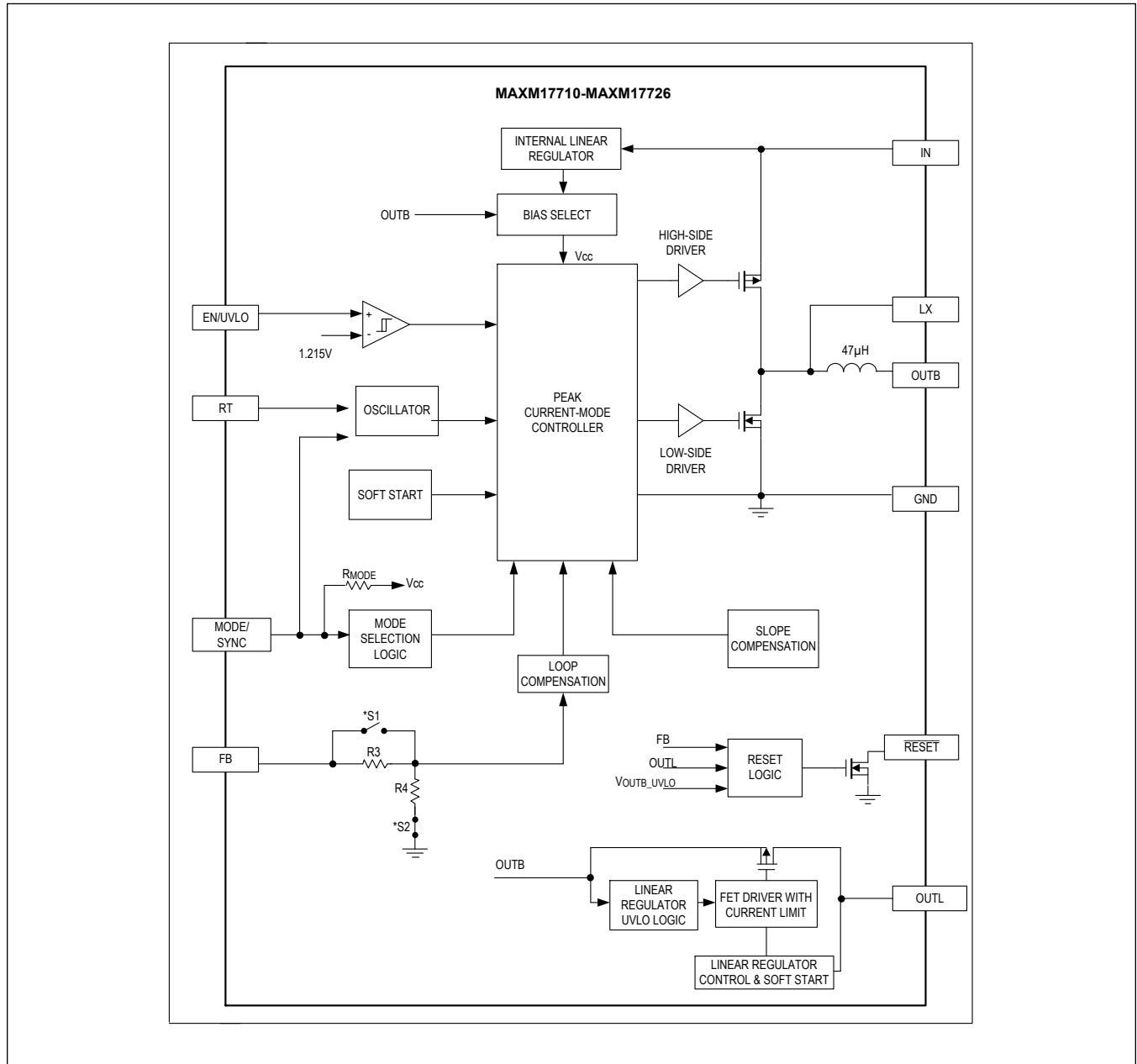

MODULE PART NUMBER	S1	S2	R3 (kΩ)	R4 (kΩ)
MAXM17710-MAXM17714	OPEN	CLOSE	257.6	82.2
MAXM17715-MAXM17720	OPEN	CLOSE	432.43	82.2
MAXM17721-MAXM17726	CLOSE	OPEN	OPEN	OPEN

Detailed Description

The MAXM17710-MAM17726 are a family of dual-output regulator modules integrating a 4V to 60V, 150mA synchronous step-down converter with internal MOSFETs, inductor, and a high PSRR, low-noise, 50mA linear regulator. The step-down converter output is connected to the input of the linear regulator inside the module. The linear regulator can deliver up to 50mA load current. The step-down converter can deliver up to 150mA current, including the current drawn by the linear regulator. The module variants offer different fixed output voltages from the linear regulator, in the range of 1.2V to 3.3V. The MAXM17710-MAXM17720 modules offer fixed output voltage from the DC-DC step-down converter. The MAXM17721-MAXM17726 modules offer adjustable step-down converter output voltage, programmable between 2.5V and 5V. The modules offer independent internal compensation circuits for step-down converters and linear regulators, eliminating the need for external compensation components.

When EN/UVLO is ascertained, an internal power-up sequence ramps up the error-amplifier reference, resulting in an output-voltage soft-start. The soft-start period is fixed internally at 5.1ms. The step-down converter features a peak-current-mode control architecture with programmable switching frequency. The MODE selection pin can be used to operate the converter in pulse-width modulation (PWM) or pulse-frequency modulation (PFM) control schemes.

On the rising edge of the internal clock, the high-side p-MOSFET turns on. An internal error amplifier compares the feedback voltage to a fixed internal reference voltage and generates an error voltage. The error voltage is compared to a sum of the current-sense voltage and a slope-compensation voltage by a PWM comparator to set the ON-time. During the ON-time of the p-MOSFET, the inductor current ramps up. For the remainder of the switching period (OFF-time), the p-MOSFET is kept off and the low-side n-MOSFET is turned ON. During the OFF-time, the inductor releases the stored energy as the inductor current ramps down, providing current to the output. During overload conditions, cycle-by-cycle current-limit feature limits the inductor peak current by turning off the high-side pMOSFET and turning on the low-side nMOSFET.

The FB pin monitors the output voltage of the step-down converter directly (for fixed output voltage variant modules) or through a resistor-divider (for adjustable output voltage variant modules). The output of the linear regulator is monitored internally in the module. The RESET pin transitions to a high-impedance state 2.1ms after both the output voltages reach 95% of their respective programmed values.

Mode Selection and External Clock Synchronization (MODE/SYNC)

The modules feature a MODE/SYNC pin. This pin has two functions, it can be used to synchronize the module to an external clock signal or for selecting the mode of operation to either forced PWM mode or PFM mode. When the MODE/SYNC pin is grounded, the module operates in constant-frequency PWM mode at all loads. When the MODE/SYNC pin is unconnected, the module operates in PFM mode at light loads. When a rising edge is detected at the MODE/SYNC pin, the internal logic changes the mode from PWM to PFM after 16 clock cycles. When a falling edge is detected, the change from PFM to PWM is instantaneous.

In PWM mode of operation, the module output current is allowed to go negative. The PWM operation is useful in frequency-sensitive applications and provides fixed switching frequency at all loads.

The PFM mode disables negative inductor current and additionally skips pulses at light loads for better efficiency. The PFM mode of operation gives higher efficiency at light loads compared to the PWM mode of operation. In PFM mode, the inductor current is forced to a fixed peak (I_{PFM}) of 92mA (typ) in every clock cycle until the output voltage rises to 102% (typ) of the nominal value. Once the output reaches 102% (typ) of the nominal value, both high-side and low-side FETs are turned off and the device enters hibernate operation until the load discharges the output voltage to 101% (typ) of the nominal voltage. Most of the internal blocks are turned off in hibernate operation to reduce quiescent current. After the output voltage falls below 101% (typ) of the nominal value, the module comes out of hibernate operation, turns on all internal blocks, and commences the process of delivering pulses of energy until the output voltage reaches 102% (typ) of the nominal value. The module naturally comes out of PFM mode and serves load requirements in PWM mode when the inductor peak current exceeds I_{PFM} (92mA typ) threshold. The module returns to PFM mode only when the load current is less than half the peak-to-peak inductor ripple current.

The internal oscillator of the module can be synchronized to an external clock signal on the MODE/SYNC pin. The external synchronization clock frequency must be between $1.1 \times f_{SW}$ and $1.4 \times f_{SW}$ where f_{SW} is the frequency programmed by the R_{RT} resistor. When an external clock is applied to MODE/SYNC pin, the internal clock synchronizes

to the external clock frequency (from the original frequency based on the RT setting) after 8 external pulses are detected within 16 internal clock cycles. The minimum external clock on-time and off-time pulse widths should be greater than 100ns. See the MODE/SYNC section in the [Electrical Characteristics](#) table for details.

Linear Regulator Input

The step-down converter output is connected to the input of the linear regulator. The linear regulator can operate in the input voltage range of 2.35V to 5V and can deliver a maximum current of 50mA.

BIAS From OUTB

The OUTB pin also functions as bootstrap input to power up the internal blocks. Switch-over to bootstrap input occurs when V_{OUTB} is above V_{OUTB_TH} . This improves the overall efficiency, since the internal blocks are being powered from the step-down converter output which has less voltage than the input voltage.

Enable/Undervoltage-Lockout Input (EN/UVLO) and Soft-Start

When EN/UVLO voltage is above 1.215V (typ), the internal error-amplifier reference voltage starts to ramp up. The duration of the soft-start ramp is 5.1ms (typ), allowing a smooth increase of the output voltage. Driving EN/UVLO low disables both power MOSFETs and linear regulator as well as other internal circuitry, and reduces V_{IN} quiescent current below 2.5 μ A (typ). The EN/UVLO can be used as an input voltage UVLO adjustment input. An external voltage divider between V_{IN} and EN/UVLO to GND adjusts the input voltage at which the module turns on or turns off. The allowed minimum turn-on/off input voltage is 4V. See the [Setting the Input Undervoltage-Lockout Level](#) section for details. If EN/UVLO is driven from an external signal source, a 1k Ω (min) series resistance is recommended between the signal source and the EN/UVLO pin.

Startup Into a Prebiased Step-Down Converter Output

The devices are capable of soft-start into a prebiased output without discharging the output capacitor in both the PFM and forced-PWM modes. Such a feature is useful in applications where digital integrated circuits with multiple rails are powered.

Reset Output ($\overline{\text{RESET}}$)

The device includes an open-drain $\overline{\text{RESET}}$ output to monitor the step-down converter output voltage and the linear regulator output voltage. To use the RESET feature, the pin has to be pulled up using an external resistor as shown in the typical application circuit.

$\overline{\text{RESET}}$ goes to high impedance, 2.1ms after both the step-down converter and linear regulator outputs rise above 95%(typ) of their nominal set value, respectively.

$\overline{\text{RESET}}$ pulls low after 4 μ s if the step-down converter output voltages fall below 92% or linear regulator output voltage falls below 91.5% of their set value. $\overline{\text{RESET}}$ is also driven low when EN/UVLO voltage falls below its threshold value.

Switching Frequency (RT)

Switching frequency of the device can be programmed from 350kHz to 2.2MHz by using a resistor connected from RT to GND. The switching frequency (f_{SW}) is related to the resistor (R_{RT}) connected at the RT pin by the following equation:

$$R_{RT} = \frac{500}{\left(\frac{11.6}{t_{SW} - 0.045}\right)^{0.5}}$$

$$t_{SW} = \frac{1}{f_{SW}}$$

where R_{RT} is in k Ω and t_{SW} is in μ s. Leave the RT pin unconnected for the default 610kHz switching frequency. The maximum allowable switching frequency for PFM mode of operation is 900kHz.

Overcurrent Protection (OCP)

The MAXM17710-MAXM17726 modules are provided with a robust overcurrent protection scheme that protects the

modules under overload and output short-circuit conditions. Device implements a hysteretic peak current limit protection scheme to protect the internal FETs and inductor under output short-circuit conditions. When the inductor peak current exceeds $I_{PEAK-LIMIT}$ (295mA typ), the high-side switch is turned off and the low-side switch is turned on to reduce the inductor current. After the current is reduced to 150mA (typ), the high-side switch is turned on at the rising edge of the next clock pulse. The part enters hiccup mode if the inductor current hits $I_{PEAK-LIMIT}$ for 16 consecutive times. In hiccup mode, the module is protected by suspending switching for a hiccup time out period (51ms typ). Once the hiccup time-out period expires, the part auto retries to startup with soft-start and the same operation continues until the short is removed and inductor peak current goes below $I_{PEAK-LIMIT}$.

The MAXM17710-MAXM17726 step-down converters are designed to support a maximum load current of 150mA.

Inductor ripple current can be calculated as follows:

$$\Delta I = \left[\frac{V_{IN} - V_{OUTB} - (5.4 \times I_{OUT})}{L \times f_{SW}} \right] \times \left[\frac{V_{OUTB} + (4 \times I_{OUT})}{V_{IN} - (1.4 \times I_{OUT})} \right]$$

$$I_{OUT} = I_{OUTB} + I_{LDO}$$

where

V_{OUTB} = Steady-state output voltage,

V_{IN} = Operating input voltage,

f_{sw} = switching frequency in Hz,

L = Inductor in the step-down converter module (47 μ H \pm 20%),

I_{OUTB} = Step-down converter load current,

I_{LDO} = LDO load current

The following condition should be satisfied at the desired load current, I_{OUT}

$$I_{OUT} + \frac{\Delta I}{2} < 0.245$$

The low-side switch in the step-down converter is protected by the sink current limit. When the low-side sink current exceeds I_{SINK_LIMIT} (105mA typ) the low-side nMOSFET turns off and the current is controlled with a hysteretic ripple of 50mA.

The linear regulator is provided with an overload and short-circuit protection. The module measures and limits the linear regulator output current, I_{LDO} to 84mA (typ). There is no timeout for overload and short-circuit protection at the output of linear regulator. The device would continue to deliver 84mA. If this causes a thermal runaway in the application, then the device would be turned off by the on-chip thermal sensor at the thermal shutdown temperature.

Thermal-Overload Protection

Thermal-overload protection limits the total power dissipation in the module. When the junction temperature exceeds +160°C (typ), an on-chip thermal sensor shuts down the device, turns off the internal power MOSFETs and the linear regulator, allowing the module to cool down. The thermal sensor turns the module on with soft-start after the junction temperature cools by 20°C.

Applications Information

Operating Input Voltage Range

The minimum and maximum operating input voltages for a given output voltage should be calculated as follows:

$$V_{IN(MIN)} = \frac{V_{OUTB} + (I_{OUT(MAX)} \times 5.9)}{1 - t_{OFF_MIN(MAX)} \times f_{SW(MAX)}} + (I_{OUTB(MAX)} \times 2.4)$$

$$V_{IN(MAX)} = \frac{V_{OUTB}}{f_{SW(MAX)} \times t_{ON_MIN(MAX)}}$$

$$f_{SW(MAX)} = f_{SW_SET} \times 1.11$$

$$I_{OUT(MAX)} = I_{OUTB(MAX)} + I_{LDO(MAX)}$$

Also, for duty cycle > 0.5;

$$f_{SW(MIN)} = f_{SW_SET} \times 0.89$$

$$V_{IN(MIN)} > (3.985 \times V_{OUTB}) - (23.05 \times 10^{-6} \times f_{SW(MIN)})$$

where

V_{OUTB} = Steady-state output voltage of step-down converter,

$I_{OUTB(MAX)}$ = Maximum load current of step-down converter,

$I_{LDO(MAX)}$ = Maximum load current of linear regulator,

f_{SW_SET} = Set switching frequency in Hz,

$t_{OFF_MIN(MAX)}$ = Worst case minimum switch off-time (80ns),

$t_{ON_MIN(MAX)}$ = Worst-case minimum switch on-time (128nsec)

Input Capacitor Selection

The input filter capacitor reduces peak currents drawn from the power source and reduces noise and voltage ripple on the input caused by the switching converter. The input capacitor RMS current requirement (I_{RMS}) is defined by the following equation:

$$I_{RMS} = I_{OUT(MAX)} \times \frac{\sqrt{V_{OUTB} \times (V_{IN} - V_{OUTB})}}{V_{IN}}$$

$$I_{OUT(MAX)} = I_{OUTB(MAX)} + I_{LDO(MAX)}$$

where $I_{OUTB(MAX)}$ is the maximum load current of the step-down converter and $I_{LDO(MAX)}$ is the maximum load current of the linear regulator. The current requirement I_{RMS} has a maximum value when the input voltage equals twice the output voltage ($V_{IN} = 2 \times V_{OUTB}$). So,

$$I_{RMS(MAX)} = \frac{I_{OUT(MAX)}}{2}$$

Choose an input capacitor that exhibits less than +10°C temperature rise at the RMS input current for optimal long-term reliability. Use low-ESR ceramic capacitors with high-ripple-current capability at the input. The X7R capacitors are recommended in industrial applications for their temperature stability. Calculate the input capacitance using the following equation:

$$C_{IN} = \frac{I_{OUT(MAX)} \times D \times (1 - D)}{\eta \times f_{SW} \times \Delta V_{IN}}$$

where

D = Duty ratio of the controller (V_{OUTB}/V_{IN}),

f_{SW} = Switching frequency in Hz,

ΔV_{IN} = Allowable input voltage ripple,

η = Efficiency of the step-down converter

See the [Typical Operating Characteristics](#) for the power-conversion efficiency or measure the efficiency.

In applications where the source is located at a distance from the device input, an input electrolytic capacitor should be added in parallel to the ceramic capacitor to provide necessary damping for potential oscillations caused by the inductance of the longer input power path and input ceramic capacitor.

Output Capacitor Selection for Step-Down Converter

Small ceramic X7R grade capacitors are sufficient and recommended for output-voltage generation. The output capacitor has two functions. It provides smooth voltage and stores sufficient energy to support the output voltage under load transient conditions and stabilizes the device's internal control loop. Usually the output capacitor is sized to support a step load of 75mA, such that the output-voltage deviation is less than 3%. The minimum required output capacitance can be calculated from the following equation:

$$C_{OUTB} = \frac{20}{V_{OUTB}}$$

where

C_{OUTB} = Capacitance to be connected at the output of step-down converter in μF and

V_{OUTB} = Output voltage of the step-down converter

Derating of ceramic capacitors with DC-bias voltage must be considered while selecting the output capacitor.

Output Capacitor Selection for the Linear Regulator

For stable operation, use a low-ESR 2.2 μF X7R ceramic capacitor at the OUTL pin as shown in [Typical Application Circuits](#). Ensure that the derated capacitance under worst-case conditions does not drop below 1 μF .

Setting the Input Undervoltage-Lockout Level

The device offers an adjustable undervoltage-lockout level. Set the voltage at which the device turns on with a resistive voltage-divider connected from IN to GND (see [Figure 1](#)). Connect the center node of the divider to the EN/UVLO pin. Choose R1 to be 3.3M Ω (max), and then calculate R2 as follows:

$$R2 = \frac{R1 \times 1.215}{(V_{INU} - 1.215)}$$

where V_{INU} is the voltage at which the device is required to turn on. V_{INU} should always be chosen to be greater than or equal to 4V.

If the EN/UVLO pin is driven from an external signal source, a series resistance of minimum 1k Ω is recommended to be placed between the signal source output and the EN/UVLO pin to reduce voltage ringing on the line.

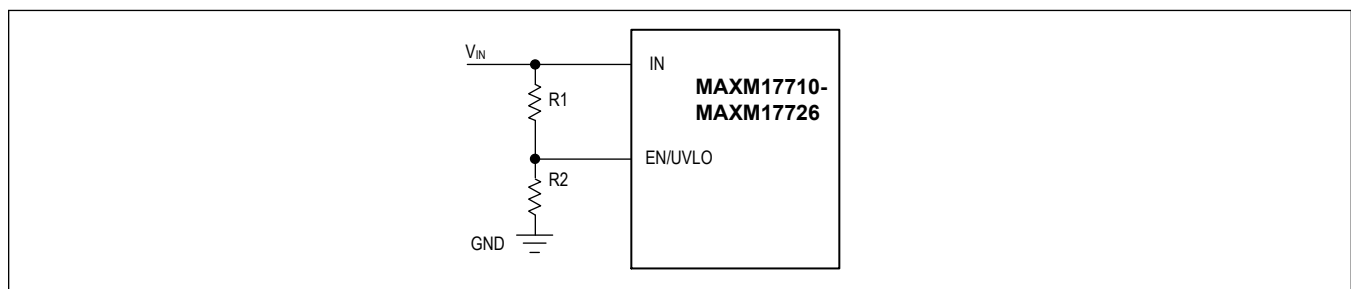

Figure 1. Setting the Undervoltage Lockout Level

Output Voltage Setting

Connect feedback (FB) of the MAXM17710-MAX17720 directly to the output node of the step-down converter for feedback control. The MAX17721-MAXM17726 output voltage can be programmed from 2.5V to 5.0V. Set the output

MAXM17710-MAXM17726

Integrated 4V-60V, 100mA, Himalaya uSLIC Power Module DC-DC Converter with 50mA Linear Regulator

voltage by connecting a resistor-divider from output node to FB to GND (see [[Setting the Output Voltage]]). Choose R4 less than or equal to 49.9kΩ and calculate R3 with the following equation:

$$R3 = R4 \times \left[\frac{V_{OUTB}}{0.8} - 1 \right]$$

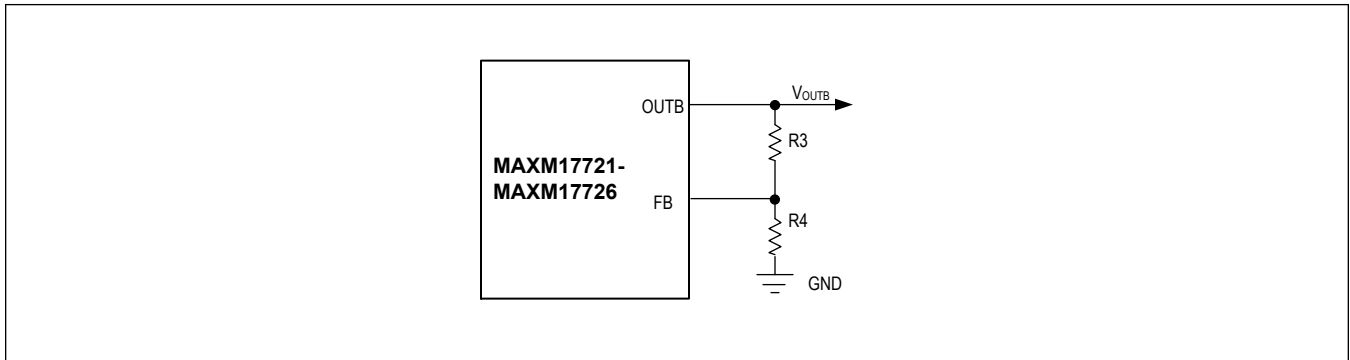

Figure 2. Setting the Output Voltage

Table 1. Selection of Components for MAXM17710-MAXM17726

PART NUMBER	V _{IN(MIN)} (V)	V _{IN(MAX)} (V)	V _{OUTB} (V)	C _{IN} (μF)	C _{OUT} (μF)	R ₃ (kΩ)	R ₄ (kΩ)	R ₅ (kΩ)	f _{sw} (kHz)
MAXM17710-MAXM17714	5.5	60	3.3	1μF 1206 100V (Taiyo yuden HMK316B7105KL)	1 x 10μF 0603 10V (Murata GRM188Z71A106KA73)	N/A	N/A	127	375
MAXM17715-MAXM17720	8.4	60	5	1μF 1206 100V (Taiyo yuden HMK316B7105KL)	1 x 10μF 0603 10V (Murata GRM188Z71A106KA73)	N/A	N/A	78.7	570
MAXM17721-MAXM17726	4.5	48	2.5	1μF 1206 100V (Taiyo yuden HMK316B7105KL)	1 x 10μF 0603 10V (Murata GRM188Z71A106KA73)	106	49.9	137	350
MAXM17721-MAXM17726	5.5	60	3.3	1μF 1206 100V (Taiyo yuden HMK316B7105KL)	1 x 10μF 0603 10V (Murata GRM188Z71A106KA73)	156	49.9	127	375
MAXM17721-MAXM17726	8.4	60	5	1μF 1206 100V (Taiyo yuden HMK316B7105KL)	1 x 10μF 0603 10V (Murata GRM188Z71A106KA73)	261	49.9	78.7	570

Linear Regulator Output Voltage Options

1.2V, 1.5V, 1.8V, 2.5V, 3V, and 3.3V linear regulator output voltage options are supported. See the [Ordering Information](#) for details.

Power Dissipation

The power dissipation inside the module leads to an increase in the junction temperature of the module. The power loss inside the module at full load can be estimated as follows:

$$P_{LOSS} = P_{BUCK} + P_{LDO}$$

$$P_{BUCK} = (V_{OUTB} \times (I_{OUTB} + I_{OUTL}) \times \left(\frac{1}{\eta} - 1 \right))$$

$$P_{LDO} = (V_{OUTB} - V_{OUTL}) \times I_{OUTL}$$

where

V_{OUTB} = Step-down converter output voltage,

I_{OUTB} = Step-down converter load current,

η = Efficiency of the step-down converter,

V_{OUTL} = LDO output voltage,

I_{OUTL} = LDO load current

See the [Typical Operating Characteristics](#) for power conversion efficiency or to measure the efficiency to determine the total power dissipation.

The junction temperature (T_J) of the module can be estimated at any given ambient temperature (T_A) from the following equation:

$$T_J = T_A + (\theta_{JA} \times P_{LOSS})$$

For the MAXM17710-MAXM17726 modules soldered on the evaluation board, the thermal resistance from junction-to-ambient (θ_{JA}) is 45°C/W. Operating the module at junction temperatures greater than +125°C degrades operating lifetimes. An EE-SIM model is available for the MAXM17710-MAXM17726 modules to simulate efficiency and power loss for the desired operating conditions.

PCB Layout Guidelines

Use the following guidelines for good PCB layout:

- Keep the input ceramic capacitors as close as possible to IN and GND pins.
- Keep the output ceramic capacitors of step-down converter as close as possible to OUTB and GND pins.
- Minimize the area formed by the LX pin to reduce the radiated EMI.
- Ensure that the feedback connection is short and direct.
- Keep LDO output capacitor close to the OUTL and GND pins.

For a sample layout that ensures first pass success, refer to the MAXM17710-MAXM17726 evaluation kit layout available at www.maximintegrated.com.

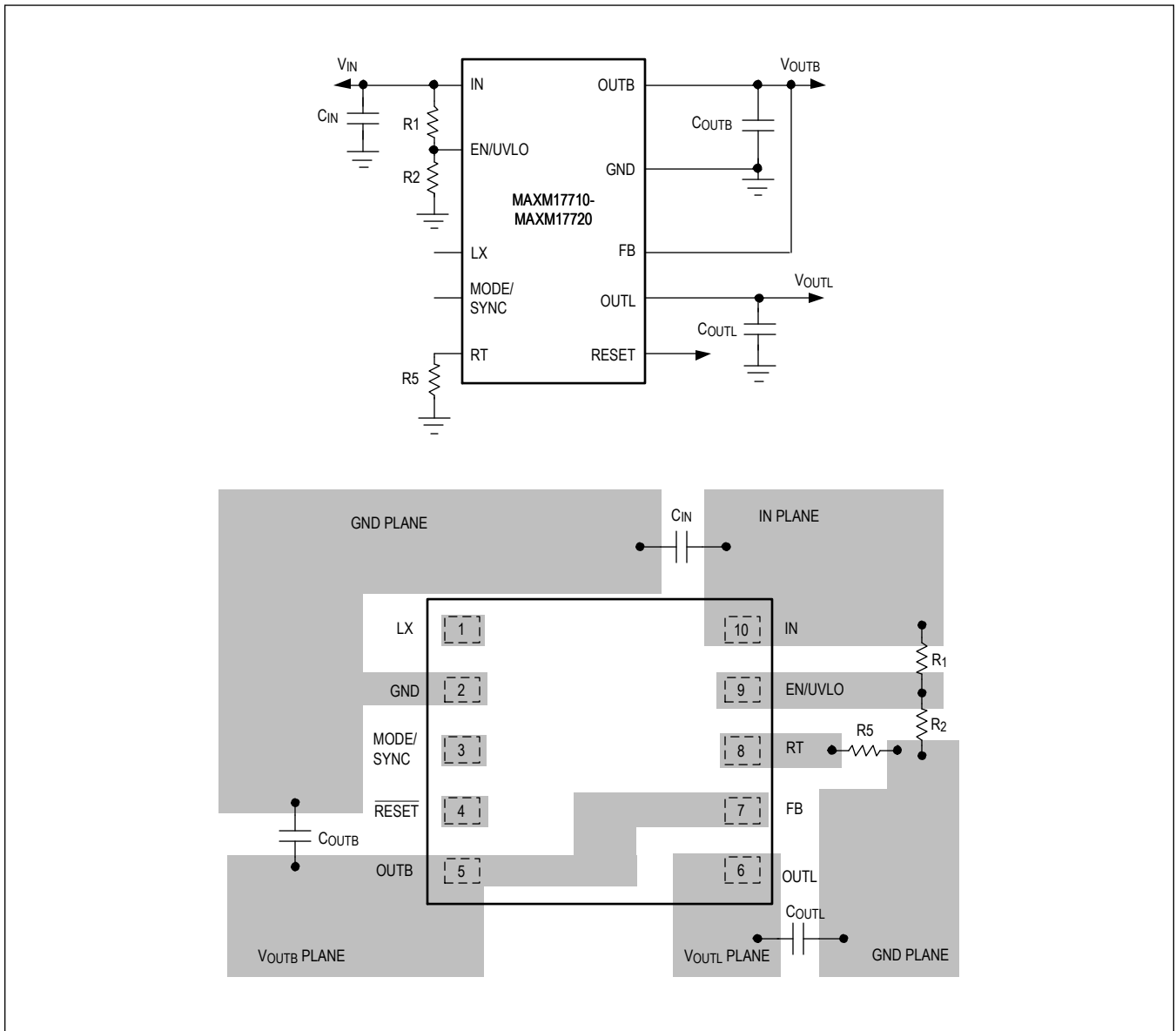

Figure 3. Fixed Output Layout Guidelines

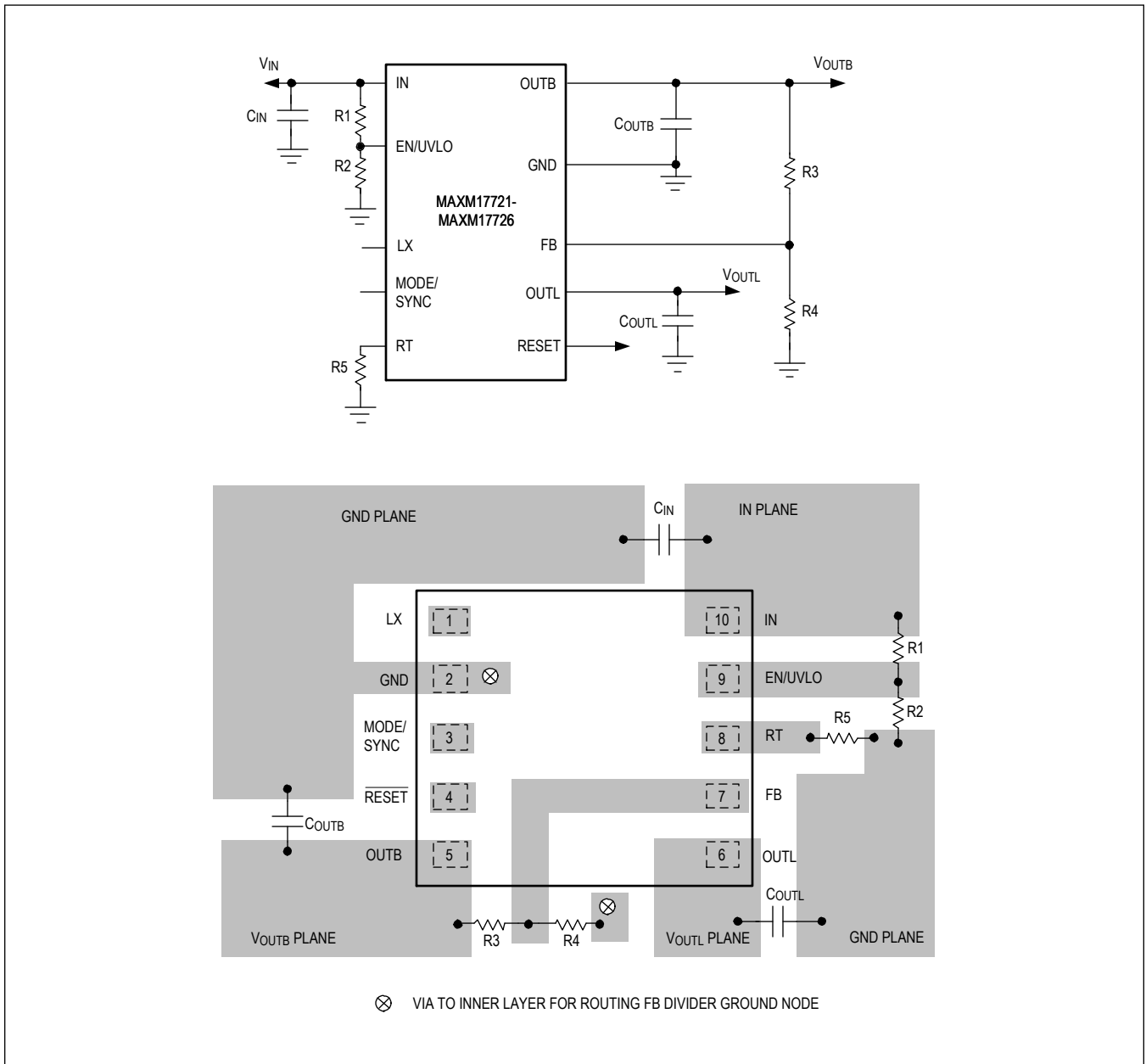
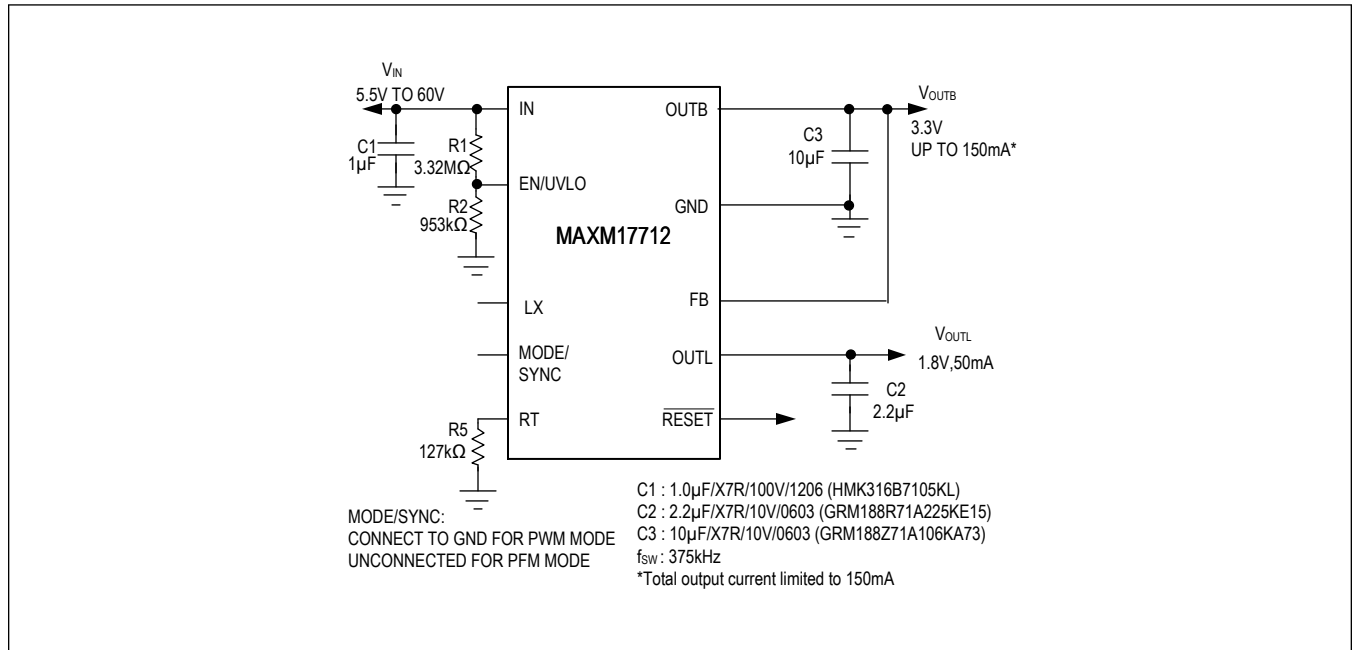

Figure 4. Adjustable Output Layout Guidelines

Typical Application Circuits

MAXM17712 Application Circuit



MAXM17720 Application Circuit

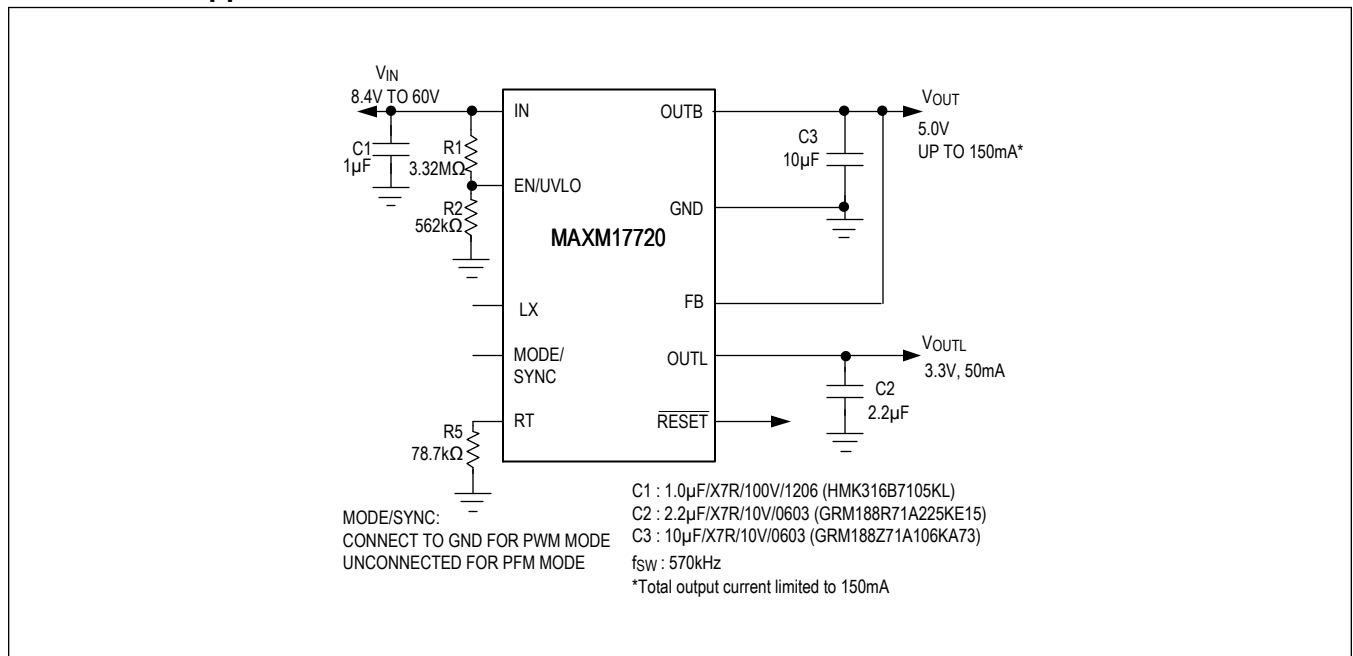

Typical Application Circuits (continued)

MAXM17724 Adjustable 5V Step-Down Converter Application Circuit

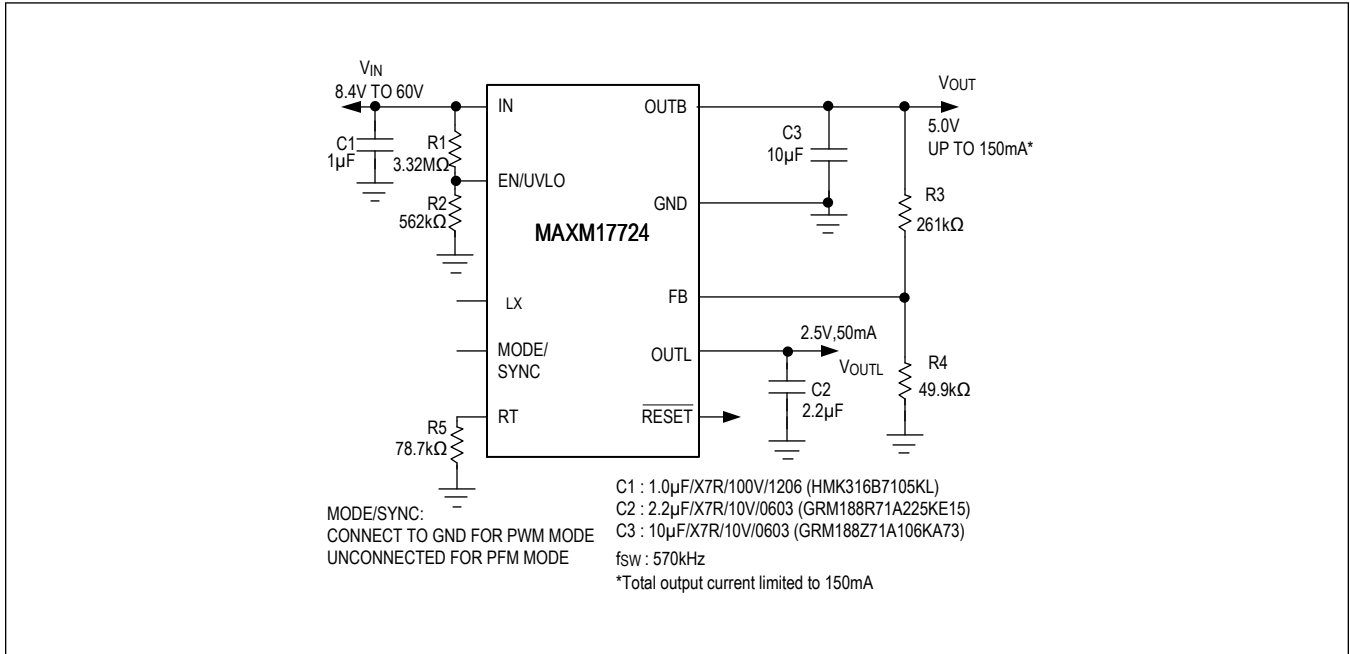

Ordering Information

PART NUMBER	TEMP RANGE	PIN-PACKAGE	STEP-DOWN CONVERTER OUTPUT VOLTAGE (V)	LINEAR REGULATOR OUTPUT VOLTAGE (V)
MAXM17710AMB+*	-40°C to +125°C	10 - uSLIC	3.3	1.2
MAXM17710AMB+T*	-40°C to +125°C	10 - uSLIC	3.3	1.2
MAXM17711AMB+*	-40°C to +125°C	10 - uSLIC	3.3	1.5
MAXM17711AMB+T*	-40°C to +125°C	10 - uSLIC	3.3	1.5
MAXM17712AMB+	-40°C to +125°C	10 - uSLIC	3.3	1.8
MAXM17712AMB+T	-40°C to +125°C	10 - uSLIC	3.3	1.8
MAXM17713AMB+*	-40°C to +125°C	10 - uSLIC	3.3	2.5
MAXM17713AMB+T*	-40°C to +125°C	10 - uSLIC	3.3	2.5
MAXM17714AMB+*	-40°C to +125°C	10 - uSLIC	3.3	3.0
MAXM17714AMB+T*	-40°C to +125°C	10 - uSLIC	3.3	3.0
MAXM17715AMB+*	-40°C to +125°C	10 - uSLIC	5	1.2
MAXM17715AMB+T*	-40°C to +125°C	10 - uSLIC	5	1.2
MAXM17716AMB+*	-40°C to +125°C	10 - uSLIC	5	1.5
MAXM17716AMB+T*	-40°C to +125°C	10 - uSLIC	5	1.5
MAXM17717AMB+*	-40°C to +125°C	10 - uSLIC	5	1.8
MAXM17717AMB+T*	-40°C to +125°C	10 - uSLIC	5	1.8
MAXM17718AMB+*	-40°C to +125°C	10 - uSLIC	5	2.5
MAXM17718AMB+T*	-40°C to +125°C	10 - uSLIC	5	2.5
MAXM17719AMB+*	-40°C to +125°C	10 - uSLIC	5	3.0
MAXM17719AMB+T*	-40°C to +125°C	10 - uSLIC	5	3.0
MAXM17720AMB+	-40°C to +125°C	10 - uSLIC	5	3.3
MAXM17720AMB+T	-40°C to +125°C	10 - uSLIC	5	3.3
MAXM17721AMB+*	-40°C to +125°C	10 - uSLIC	Adjustable	1.2
MAXM17721AMB+T*	-40°C to +125°C	10 - uSLIC	Adjustable	1.2
MAXM17722AMB+*	-40°C to +125°C	10 - uSLIC	Adjustable	1.5
MAXM17722AMB+T*	-40°C to +125°C	10 - uSLIC	Adjustable	1.5
MAXM17723AMB+*	-40°C to +125°C	10 - uSLIC	Adjustable	1.8
MAXM17723AMB+T*	-40°C to +125°C	10 - uSLIC	Adjustable	1.8
MAXM17724AMB+	-40°C to +125°C	10 - uSLIC	Adjustable	2.5
MAXM17724AMB+T	-40°C to +125°C	10 - uSLIC	Adjustable	2.5
MAXM17725AMB+*	-40°C to +125°C	10 - uSLIC	Adjustable	3
MAXM17725AMB+T*	-40°C to +125°C	10 - uSLIC	Adjustable	3
MAXM17726AMB+*	-40°C to +125°C	10 - uSLIC	Adjustable	3.3
MAXM17726AMB+T*	-40°C to +125°C	10 - uSLIC	Adjustable	3.3

*Future product-contact factory for availability

+ Denotes a lead(Pb)-free/RoHS-compliant package.

T Denotes tape-and-reel.

MAXM17710-MAXM17726

Integrated 4V-60V, 100mA, Himalaya uSLIC
Power Module DC-DC Converter with 50mA
Linear Regulator

Revision History

REVISION NUMBER	REVISION DATE	DESCRIPTION	PAGES CHANGED
0	6/19	Initial release	—
1	7/21	Updated Pin Configuration; updated TOC42 in <i>Typical Operating Characteristics</i> section; updated MAXM17712 Application Circuit in <i>Typical Application Circuit</i> section	13, 10, 24

For pricing, delivery, and ordering information, please visit Maxim Integrated's online storefront at <https://www.maximintegrated.com/en/storefront/storefront.html>.

Maxim Integrated cannot assume responsibility for use of any circuitry other than circuitry entirely embodied in a Maxim Integrated product. No circuit patent licenses are implied. Maxim Integrated reserves the right to change the circuitry and specifications without notice at any time. The parametric values (min and max limits) shown in the Electrical Characteristics table are guaranteed. Other parametric values quoted in this data sheet are provided for guidance.