

DESCRIPTION

The EV8772-Q-00A Evaluation Board is designed to demonstrate the capabilities of MPS' MP8772, a fully-integrated high-frequency, synchronous rectified, step-down, switch-mode converter with internal power MOSFETs. It offers a very compact solution to achieve a 12A continuous output current over a wide input range, with excellent load and line regulation. The MP8772 has synchronous-mode operation for higher efficiency over the output current-load range.

Constant On-Time control operation provides very fast transient response and easy loop design as well as very tight output regulation.

Full protection features include SCP, OCP, UVP, and thermal shutdown.

The MP8772 requires a minimal number of readily-available, standard, external components and is available in a space-saving QFN-16 (3mmx3mm) package.

ELECTRICAL SPECIFICATION ⁽¹⁾

Parameter	Symbol	Value	Units
Input Voltage	V _{IN}	12	V
Output Voltage	V _{OUT}	1	V
Output Current	I _{OUT}	12	A

Features

- Wide 4.5V-to-17V Operating Input Range
- 16mΩ/5.5mΩ Low-R_{DS(ON)} Internal Power MOSFETs
- 100μA Low IQ Current
- High-Efficiency Synchronous-Mode Operation
- Pre-biased Startup
- Fixed 700kHz Switching Frequency
- External Programmable Soft Startup Time
- EN and Power Good for Power Sequencing
- Over-Current Protection and Hiccup
- Thermal Shutdown
- Output Adjustable from 0.6V
- Available in a QFN-16 (3mmx3mm) package

APPLICATIONS

- Security Camera
- Portable Device, XDSL Device
- Digital Set-Top Boxes
- Flat-Panel Television and Monitors
- General Purposes

Notes:

1) For different Input/output voltage specs and different output capacitor/inductor may need change the application circuit parameters

All MPS parts are lead-free, halogen free, and adhere to the RoHS directive. For MPS green status, please visit MPS website under Quality Assurance.

"MPS" and "The Future of Analog IC Technology" are Registered Trademarks of Monolithic Power Systems, Inc.

EV8772-Q-00A EVALUATION BOARD

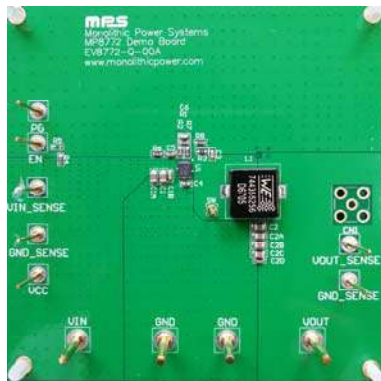

(L x W) 85mm x 85mm

Board Number	MPS IC Number
EV8772-Q-00A	MP8772GQ

Efficiency vs. Load Current

V_{OUT}=1V, L=0.56μH, DCR=1.5mΩ

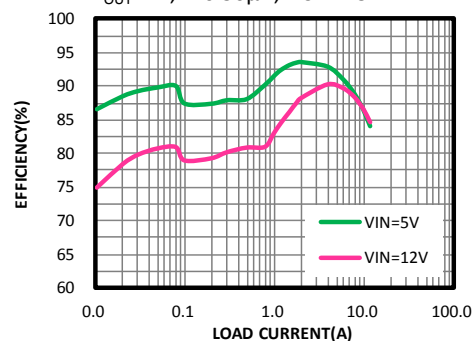

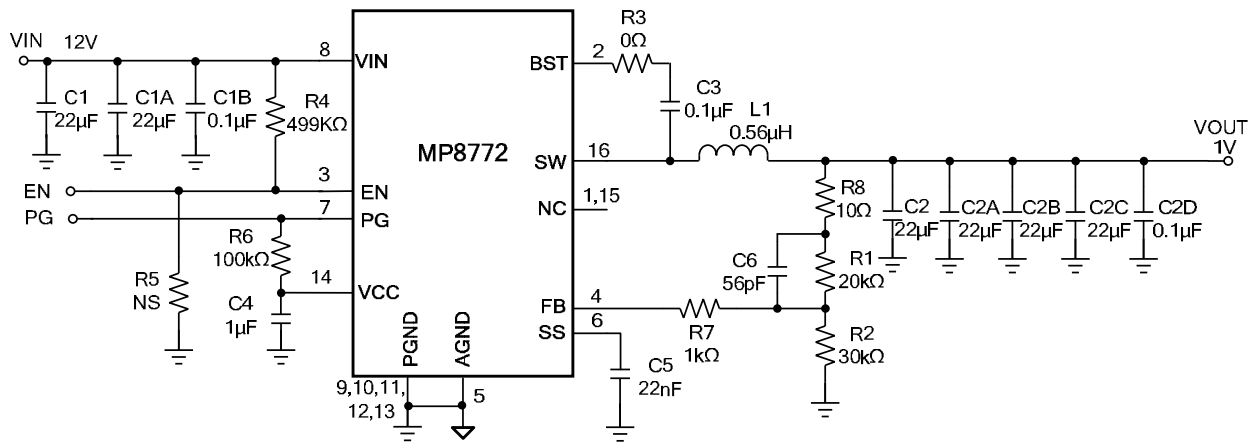
EVALUATION BOARD SCHEMATIC

EV8772-Q-00A BILL OF MATERIALS

Qty	Ref	Value	Description	Package	Manufacturer	Part Number
6	C1,C1A, C2,C2A, C2B,C2C	22μF	Ceramic Cap., 25V, X5R	0805	muRata	GRM21BR61E226ME44L
3	C1B,C2D C3	0.1μF	Ceramic Cap., 25V, X7R	0603	muRata	GRM188R71E104KA01D
1	C4	1μF	Ceramic Cap., 25V, X7R	0603	muRata	GRM188R71E105KA12D
1	C5	22nF	Ceramic Cap., 16V, X7R	0603	muRata	GRM188R71C223KA01D
1	C6	56pF	Ceramic Cap., 50V, C0G	0603	muRata	GRM1885C1H560JA01D
1	R1	20k	Thick Film Res., 1%	0603	Yageo	RC0603FR-0720KL
1	R2	30k	Thick Film Res., 1%	0603	Yageo	RC0603FR-0730KL
1	R3	0Ω	Thick Film Res., 1%	0603	Yageo	RC0603FR-070RL
1	R4	499k	Thick Film Res., 1%	0603	Yageo	RC0603FR-07499KL
0	R5,R9, R10	NS		0603		
1	R6	100k	Thick Film Res., 1%	0603	Yageo	RC0603FR-07100KL
1	R7	1k	Thick Film Res., 1%	0603	Yageo	RC0603FR-071KL
1	R8	10Ω	Thick Film Res., 1%	0603	Yageo	RC0603JR-0710RL
1	L1	0.56μH	Inductor, DCR=1.5mΩ,Is=30A	SMD	Würth	744355256
1	U1	MP8772	Synchronous Step-Down Convert	QFN-16 (3mmx3mm)	MPS	MP8772GQ

EVB TEST RESULTS

$V_{IN} = 12V$, $V_{OUT} = 1V$, $L = 0.56\mu H$, $T_A = +25^\circ C$, unless otherwise noted.

Efficiency vs. Load Current

$V_{OUT}=1V$, $L=0.56\mu H$, $DCR=1.5m\Omega$

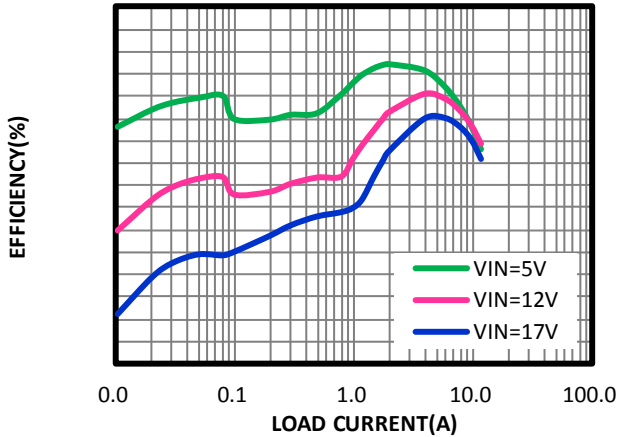

Load Regulation vs. Load Current

$V_{OUT}=1V$

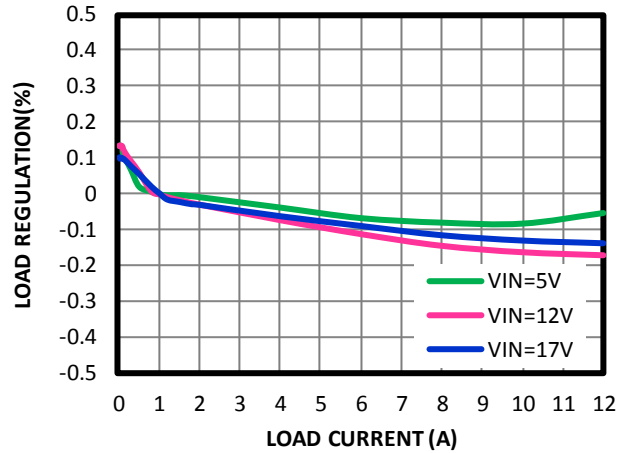

Line Regulation vs. Input Voltage

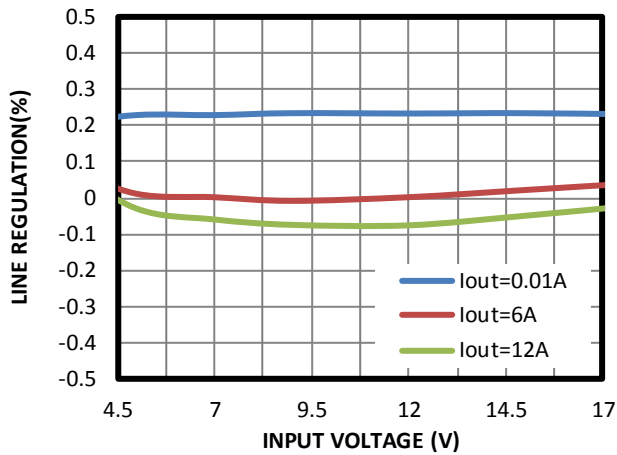

EVB TEST RESULTS *(continued)*

$V_{IN} = 12V$, $V_{OUT} = 1V$, $L = 0.56\mu H$, $T_A = +25^\circ C$, unless otherwise noted.

Input/Output Ripple

$I_{OUT}=0A$

CH1: V_{OUT}/AC
50mV/div.
CH2: V_{IN}/AC
50mV/div.
CH3: V_{SW}
5V/div.
CH4: I_L
2A/div.

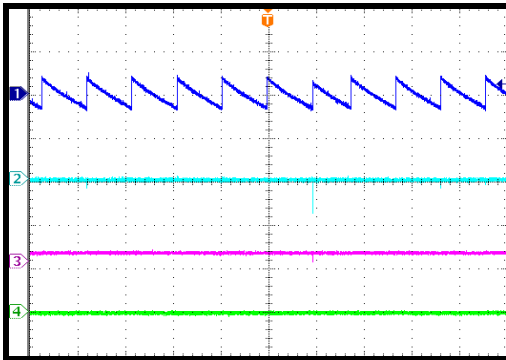

100ms/div.

Input/Output Ripple

$I_{OUT}=0A$

CH1: V_{OUT}/AC
50mV/div.
CH2: V_{IN}/AC
100mV/div.
CH3: V_{SW}
10V/div.
CH4: I_L
5A/div.

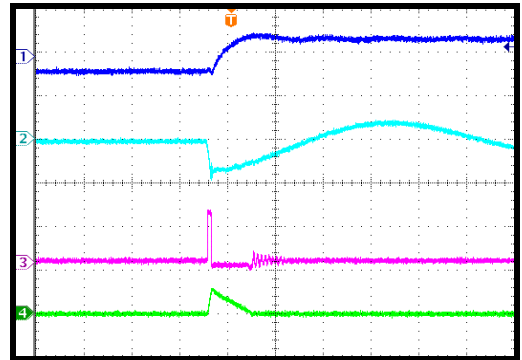

2µs/div.

Input/Output Ripple

$I_{OUT}=12A$

CH1: V_{OUT}/AC
10mV/div.
CH2: V_{IN}/AC
500mV/div.
CH3: V_{SW}
10V/div.
CH4: I_L
10A/div.

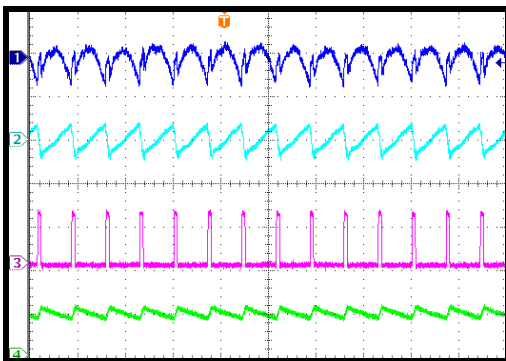

2µs/div.

Start-Up through Input Voltage

$I_{OUT}=0A$

CH1: V_{OUT}
1V/div.
CHR1: V_{PG}
5V/div.
CH2: V_{IN}
10V/div.
CH3: V_{SW}
10V/div.
CH4: I_L
10A/div.

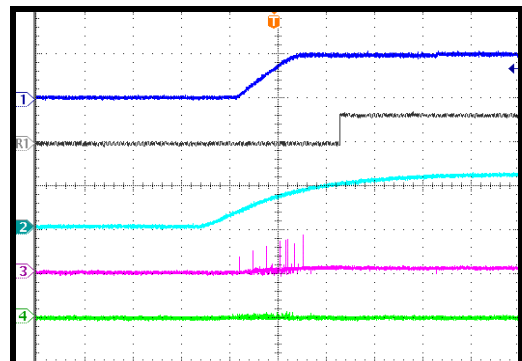

2ms/div.

Start-Up through Input Voltage

$I_{OUT}=12A$

CH1: V_{OUT}
1V/div.
CHR1: V_{PG}
5V/div.
CH2: V_{IN}
10V/div.
CH3: V_{SW}
200mV/div.
CH4: I_L
10A/div.

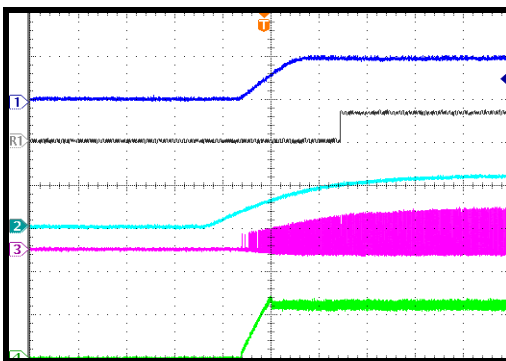

2ms/div.

Shutdown through Input Voltage

$I_{OUT}=0A$

CH1: V_{OUT}
1V/div.
CHR1: V_{PG}
5V/div.
CH2: V_{IN}
10V/div.
CH3: V_{SW}
10V/div.
CH4: I_L
10A/div.

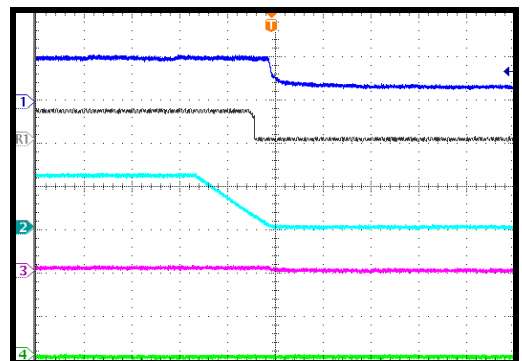

40ms/div.

EVB TEST RESULTS *(continued)*

$V_{IN} = 12V$, $V_{OUT} = 1V$, $L = 0.56\mu H$, $T_A = +25^\circ C$, unless otherwise noted.

Shutdown through Input Voltage

$I_{OUT}=12A$

CH1: V_{OUT}
1V/div.
CHR1: V_{PG}
5V/div.
CH2: V_{IN}
10V/div.
CH3: V_{SW}
200mV/div.
CH4: I_L
10A/div.

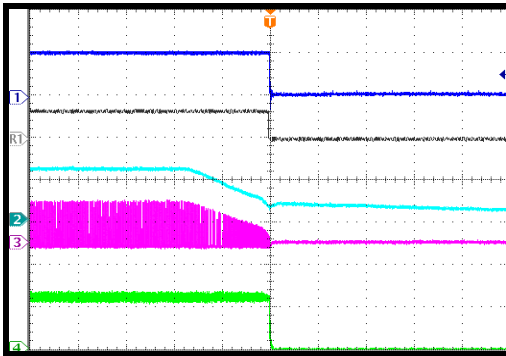

2ms/div.

Start-Up through EN

$I_{OUT}=0A$

CH1: V_{OUT}
1V/div.
CHR1: V_{PG}
5V/div.
CH2: V_{EN}
5V/div.
CH3: V_{SW}
10V/div.
CH4: I_L
10A/div.

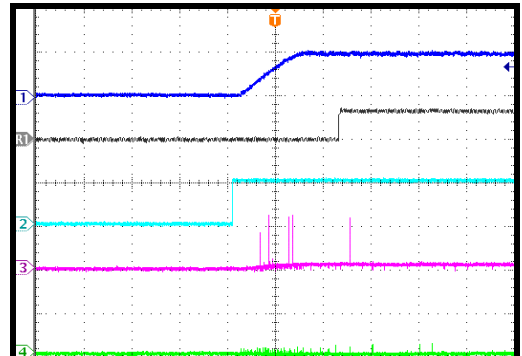

2ms/div.

Start-Up through EN

$I_{OUT}=12A$

CH1: V_{OUT}
1V/div.
CHR1: V_{PG}
5V/div.
CH2: V_{EN}
5V/div.
CH3: V_{SW}
200mV/div.
CH4: I_L
10A/div.

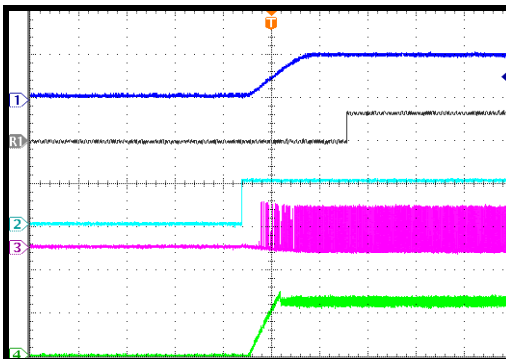

2ms/div.

Shutdown through EN

$I_{OUT}=0A$

CH1: V_{OUT}
1V/div.
CHR1: V_{PG}
5V/div.
CH2: V_{EN}
5V/div.
CH3: V_{SW}
10V/div.
CH4: I_L
10A/div.

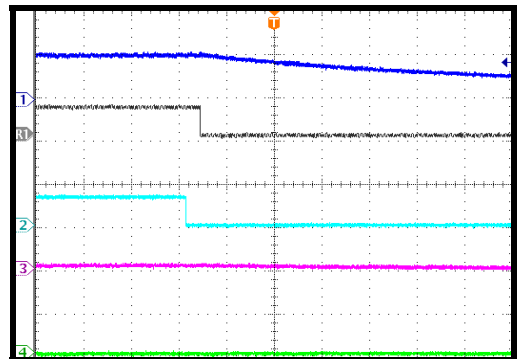

400ms/div.

Shutdown through EN

$I_{OUT}=12A$

CH1: V_{OUT}
1V/div.
CHR1: V_{PG}
5V/div.
CH2: V_{EN}
5V/div.
CH3: V_{SW}
20m0V/div.
CH4: I_L
10A/div.

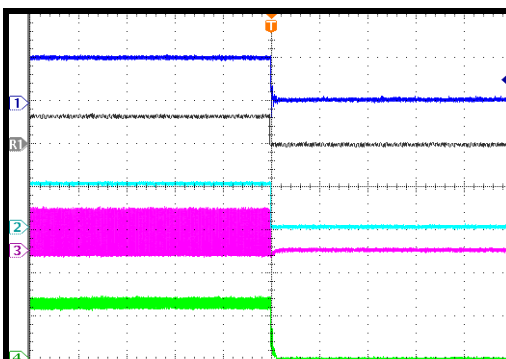

1ms/div.

Short Circuit Protection Entry

$I_{OUT}=0A$

CH1: V_{OUT}
1V/div.
CH2: V_{PG}
5V/div.
CH3: V_{SW}
10V/div.
CH4: I_L
10A/div.

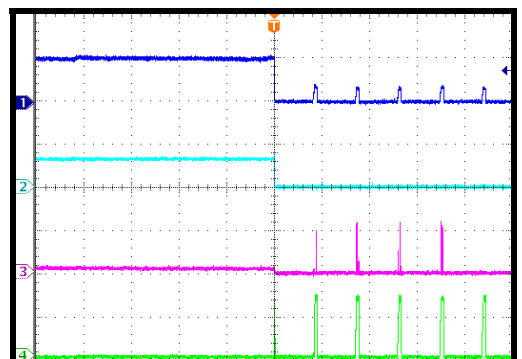

20ms/div.

EVB TEST RESULTS *(continued)*

$V_{IN} = 12V$, $V_{OUT} = 1V$, $L = 0.56\mu H$, $T_A = +25^\circ C$, unless otherwise noted.

Short Circuit Protection Steady State
Short Output to GND

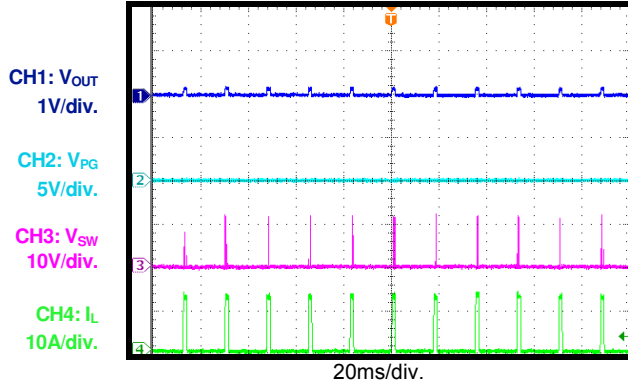

Short Circuit Protection Recovery
 $I_{OUT}=0A$

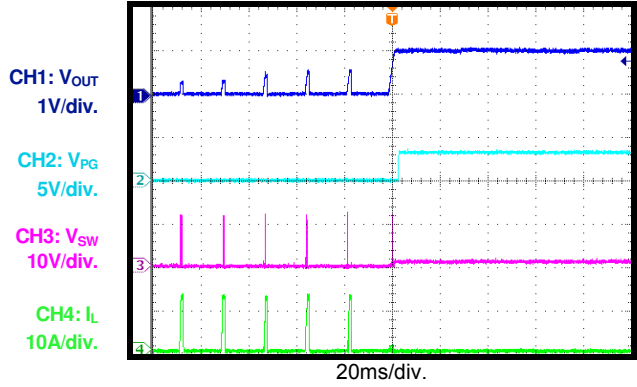

Load Transient
 $I_{OUT}=6A-12A$

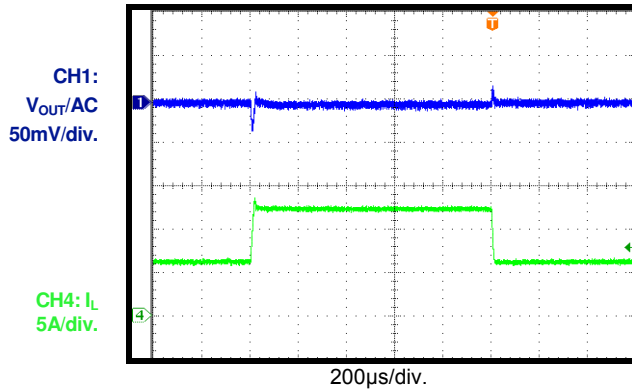

PRINTED CIRCUIT BOARD LAYOUT

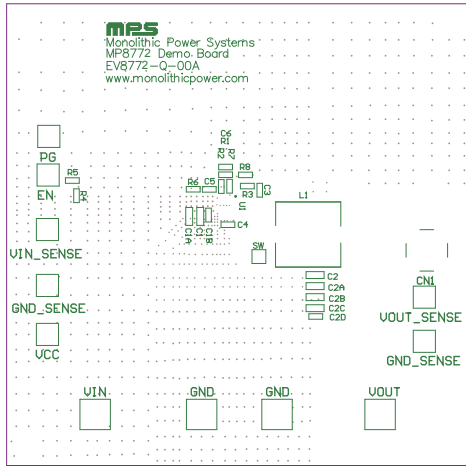

Figure 1—Top Silk Layer

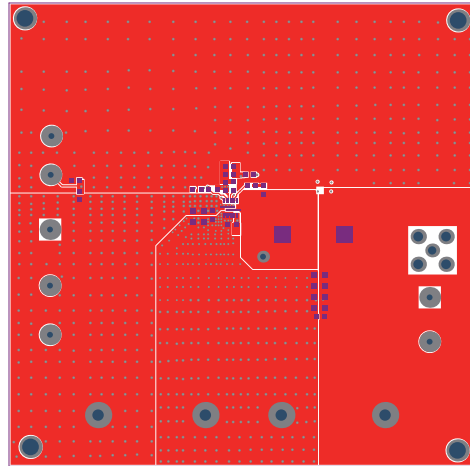

Figure 2—Top Layer

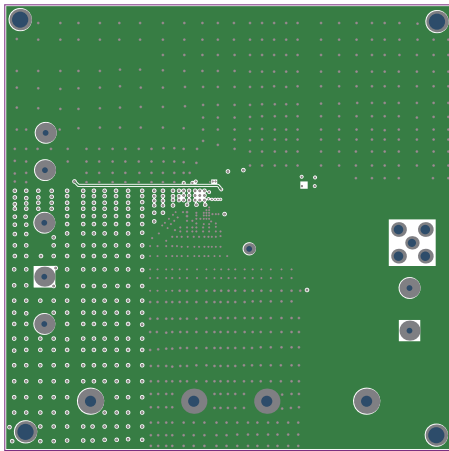

Figure 3—Inner Layer 1

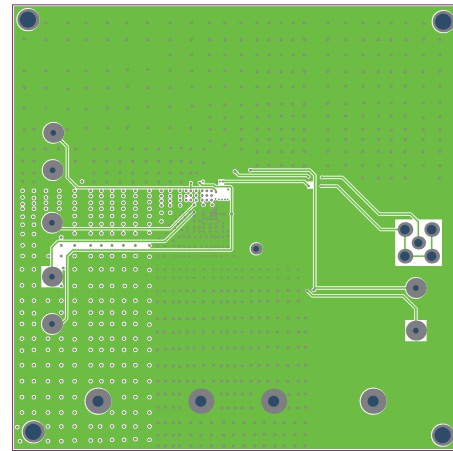

Figure 4—Inner Layer 2

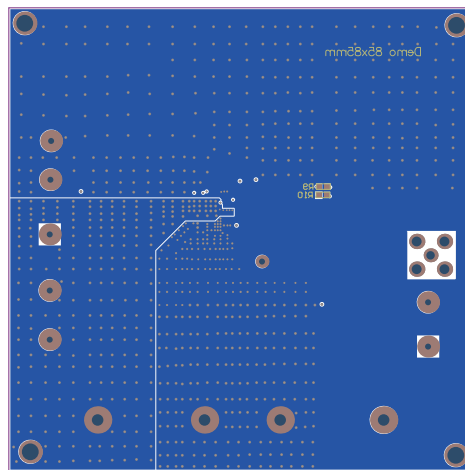

Figure 5—Bottom Layer

QUICK START GUIDE

1. Preset Power Supply to 12V.
2. Turn Power Supply off.
3. Connect Power Supply terminals to:
 - a. Positive (+): VIN
 - b. Negative (-): GND
4. Connect Load to:
 - a. Positive (+): VOUT
 - b. Negative (-): GND
5. Turn Power Supply on after making connections. The board will automatically start up.
6. To use the Enable function, apply a digital input to the EN pin. Drive EN higher than 1.2V to turn on the regulator, or less than 0.9V to turn it off.

NOTICE: The information in this document is subject to change without notice. Please contact MPS for current specifications. Users should warrant and guarantee that third party Intellectual Property rights are not infringed upon when integrating MPS products into any application. MPS will not assume any legal responsibility for any said applications.