

UCC28056BEVM-296 Evaluation Module

This user's guide provides basic evaluation instruction from a viewpoint of system operation of a stand-alone PFC boost power converter.

Contents

1	Introduction	4
2	Description	4
3	Performance Specifications	6
4	Test Setup	6
5	Test Points	8
6	Terminals	8
7	Test Procedure	8
8	Performance Data and Typical Characteristic Curves.....	10
9	Schematic, Assembly Drawing and Bill of Materials.....	17

List of Figures

1	UCC28056BEVM-296 Recommended Test Setup.....	7
2	Efficiency	10
3	Load Regulation versus Output Power	10
4	Line Regulation versus Input Voltage	11
5	Power Factor versus Output Power	11
6	THD versus Output Power	12
7	85 VAC Start-up No Load	12
8	115 VAC Start-up No Load	12
9	115 VAC Start-up Full Load	12
10	230 VAC Start-up No Load	12
11	230 VAC Start-up Full Load	12
12	265 VAC Start-up No Load	12
13	265 VAC Start-up Full Load	13
14	Low-Line Voltage and Current.....	14
15	High-Line Voltage and Current	14
16	85 VAC Valley Switching 50-mA Load	14
17	115 VAC Valley Switching 50-mA Load	14
18	230 VAC Valley Switching 100-mA Load	14
19	265 VAC Valley Switching 100-mA Load	14
20	Q1 Max Vds Stress	15
21	D4 Max Voltage Stress	16
22	UCC28056BEVM-296 Schematic	17
23	UCC28056BEVM-296 Top Assembly Drawing (Top view)	18
24	UCC28056BEVM-296 Bottom Layer Assembly Drawing (Top view).....	18
25	UCC28056BEVM-296 Top Copper Assembly Drawing (Top view).....	19
26	UCC28056BEVM-296 Bottom Copper Assembly Drawing (Top view).....	19

List of Tables

1	EVM Performance Specification	6
2	Test Points.....	8
3	List of Terminals	8
4	Total Standby Power.....	10
5	Bill of Materials	20

Trademarks

All trademarks are the property of their respective owners.

0.1 General Texas Instruments High Voltage Evaluation (TI HV EVM) User Safety Guidelines



Always follow TI's setup and application instructions, including use of all interface components within their recommended electrical rated voltage and power limits. Always use electrical safety precautions to help ensure your personal safety and those working around you. Contact TI's Product Information Center <http://support/ti.com> for further information.

Save all warnings and instructions for future reference.

WARNING

Failure to follow warnings and instructions may result in personal injury, property damage or death due to electrical shock and burn hazards.

The term TI HV EVM refers to an electronic device typically provided as an open framed, unenclosed printed circuit board assembly. It is *intended strictly for use in development laboratory environments, solely for qualified professional users having training, expertise and knowledge of electrical safety risks in development and application of high voltage electrical circuits. Any other use and/or application are strictly prohibited by Texas Instruments.* If you are not suitable qualified, you should immediately stop from further use of the HV EVM.

1. Work Area Safety

- a. Keep work area clean and orderly.
- b. Qualified observer(s) must be present anytime circuits are energized.
- c. Effective barriers and signage must be present in the area where the TI HV EVM and its interface electronics are energized, indicating operation of accessible high voltages may be present, for the purpose of protecting inadvertent access.
- d. All interface circuits, power supplies, evaluation modules, instruments, meters, scopes and other related apparatus used in a development environment exceeding 50Vrms/75VDC must be electrically located within a protected Emergency Power Off EPO protected power strip.
- e. Use stable and nonconductive work surface.
- f. Use adequately insulated clamps and wires to attach measurement probes and instruments. No freehand testing whenever possible.

2. Electrical Safety

As a precautionary measure, it is always a good engineering practice to assume that the entire EVM may have fully accessible and active high voltages.

- a. De-energize the TI HV EVM and all its inputs, outputs and electrical loads before performing any electrical or other diagnostic measurements. Revalidate that TI HV EVM power has been safely de-energized.
- b. With the EVM confirmed de-energized, proceed with required electrical circuit configurations, wiring, measurement equipment connection, and other application needs, while still assuming the EVM circuit and measuring instruments are electrically live.
- c. After EVM readiness is complete, energize the EVM as intended.

WARNING

While the EVM is energized, never touch the EVM or its electrical circuits, as they could be at high voltages capable of causing electrical shock hazard.

3. Personal Safety
 - a. Wear personal protective equipment (for example, latex gloves or safety glasses with side shields) or protect EVM in an adequate lucent plastic box with interlocks to protect from accidental touch.

Limitation for safe use:

EVMs are not to be used as all or part of a production unit.

1 Introduction

The purpose of the UCC28056BEVM-296 (EVM) is to aid in evaluation of the UCC28056X transition mode boost PFC converter. The EVM is a stand-alone PFC converter designed to operate with 85 to 265 V_{RMS}, 47 to 63 Hz, AC input and up to 165-W DC output from 90 VAC to 265 VAC and 140 W at 85 VAC. The EVM can be used as it is delivered without additional work to evaluate a transition mode boost PFC converter. This user's guide provides basic evaluation instruction from a viewpoint of system operation of a stand-alone PFC boost power converter.

2 Description

2.1 Typical Applications

This EVM is used in the following applications:

- AC adapter front end
- Set top box
- Desktop computing
- Gaming
- Electronic lamp ballast
- Digital TV
- Entry-level server and web server

2.2 Features

This EVM has the following features:

- Unified algorithm for working in critical mode (CRM) and discontinuous conduction mode (DCM) with a high power factor across the entire operating range
- AC input voltage from 85 to 265 V_{RMS}
- AC line frequency from 47 to 63 Hz
- Up to 165-W output power
- High efficiency
- TM, DCM control gives improved light-load efficiency
- Burst mode for reduced standby consumption
- Non-linear gain gives improved transient response
- User-adjustable valley switching
- Robust full-featured protection including overtemperature protection, brown-out protection, output overvoltage, cycle-by-cycle overcurrent, and gross overcurrent protections
- Test points to facilitate device and topology evaluation

2.3 Using the EVM with UCC28056A

To use this EVM with UCC28056A:

1. Replace U1 with UCC28056A.

Note that the OVP1 protection level is triggered at 421 V output because of the lower threshold of this variant.

2.4 Using the EVM with UCC28056C

To use this EVM with UCC28056C:

1. Replace U1 with UCC28056C.

3 Performance Specifications

Table 1 displays the EVM performance specifications.

Table 1. EVM Performance Specification

PARAMETER	TEST CONDITIONS	MIN	TYP	MAX	UNITS
Input Characteristics					
AC Voltage Range		85		265	V _{RMS}
AC Voltage Frequency		47		63	Hz
VCC UVLO On			10.65		VDC
VCC UVLO Off			8.85		VDC
Input DC Current	Input = 85 VAC, Full Load = 165 W		1.85		Arms
	Input = 115 VAC, Full Load = 165 W		1.43		
	Input = 230 VAC, Full Load = 165 W		0.71		
	Input = 265 VAC, Full Load = 165 W		0.64		
Output Characteristics					
Output Voltage	No Load to Full Load		390		VDC
Output Power	90 to 265 VAC			165	W
Output Power	85 VAC			140	W
Output Voltage Ripple				10	V _{pp}
System Characteristics					
Peak Efficiency				97	%
Operating Temperature	Natural Convection		25		°C

4 Test Setup

4.1 Test Equipment

DC Voltage Source: External DC input for V_{CC}. The DC source must be capable of supplying 12 V and up to 100 mA.

AC Voltage Source: Capable of single-phase output AC voltage 85 to 265 VAC, 47 to 63 Hz, adjustable, with minimum power rating 200 W and current limit function. The AC voltage source to be used must meet IEC60950 reinforced insulation requirement.

DC Digital Multimeter: One unit capable of 0 to 450 VDC input range, four-digit display preferred

Output Load: DC load capable of receiving 380 to 410 VDC, 0.5 A, and 0 to 200 W or greater, with the capability to display load current, load power, and so forth.

Digital AC Power Meter: Capable of 0 to 300 VAC voltage measurement, 0 to 10 Arms current measurement. Native power factor measurement and input current THD measurement is preferred.

Oscilloscope: Capable of 500-MHz full bandwidth, digital or analog: if digital, 5 Gsps, or better.

Fan: 200 to 400 LFM forced air cooling is recommended, but not required.

Recommended Wire Gauge: Capable of 10 A, or better than #14 AWG, with the total length of wire less than 8 feet (4 feet input and 4 feet return).

4.2 Recommended Test Setup

Figure 1 illustrates the recommended test setup.

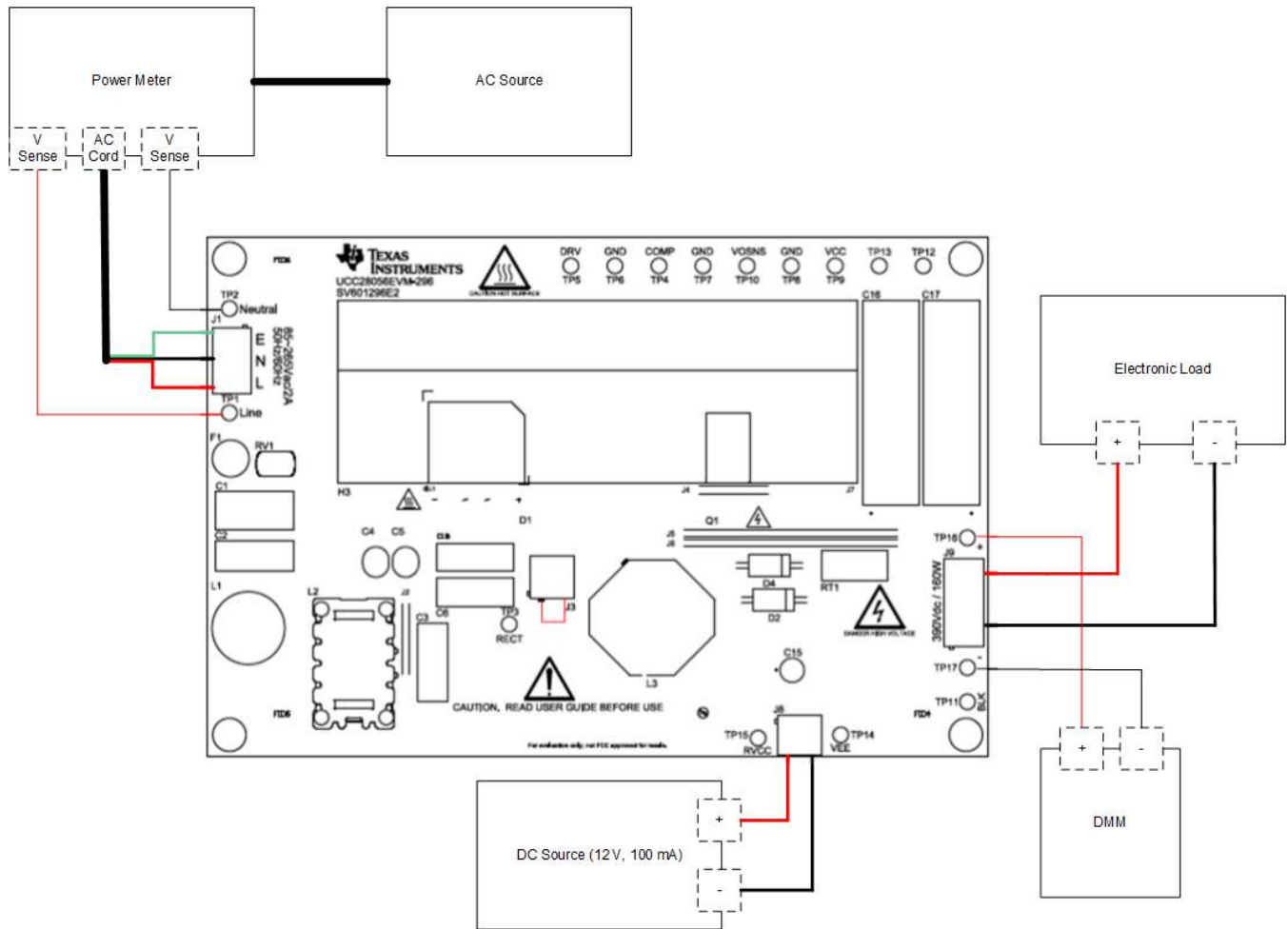

Figure 1. UCC28056BEVM-296 Recommended Test Setup

WARNING

High voltages that may cause injury exist on this evaluation module (EVM). Please ensure all safety procedures are followed when working on this EVM. Never leave a powered EVM unattended.

5 Test Points

Table 2 lists the EVM test points.

Table 2. Test Points

TEST POINTS	NAME	DESCRIPTION
TP1	Line	AC line
TP2	Neutral	AC neutral
TP3	Rect	AC rectifier output
TP4	COMP	Transconductance amplifier output
TP5	DRV	Gate-drive output
TP6	GND	Ground
TP7	GND	Ground
TP8	GND	Ground
TP9	VCC	V _{CC} sense
TP10	VOSNS	Voltage error amplifier inverting input
TP11	BLK	Bulk sense
TP12	TP12	Small signal injection terminal
TP13	TP13	Small signal injection terminal
TP14	VEE	DC input ground
TP15	RVCC	Positive DC input
TP16	VOUT+	Output voltage
TP17	VOUT–	Output voltage return

6 Terminals

Table 3 lists the EVM terminals.

Table 3. List of Terminals

TERMINAL	NAME	DESCRIPTION
J1	AC Input	3-pin, AC power input, 85 V–265 V
J3	I_IND	Inductor current sense
J8	RVCC	2-pin, DC power input, 12 V typical
J9	VOUT	4-pin, output voltage terminal, 390 V typical

7 Test Procedure

Use the following steps for the test procedure:

1. Refer to Figure 1 for basic setup. Table 2 lists the required equipment for this measurement.
2. Before making electrical connections, visually check the board to make sure there are no suspected spots of damage.
3. Use a loop of wire to short the J3 terminals. Connect a current probe around the wire loop to measure the inductor current using an oscilloscope.
4. Keep the AC voltage source output off. Connect the AC source to the input of the AC power meter. Connect the output of the AC power meter to J1 with AC_line to J1-3, AC_earth to J1-1, and AC_neutral to J1-2. Isolate the AC voltage source and meet the IEC60950 requirement. Set the AC output voltage and frequency within the range specified in Table 1, between 85 and 265 VAC and 47 to 63 Hz. Set the AC source current limit to 8.5 A.

CAUTION

While the EVM does have a fuse installed, failure to set an appropriate current limit may result in damage to the fuse or other EVM components.

5. Keep the DC voltage source output off. Connect the DC source to J2. Set the DC output voltage to 12 V and the current limit to 100 mA.
6. Connect an electronic load set to either constant-current mode or constant-resistance mode. The load range is from 0 to 423 mA.
7. If the load does not have a current or a power display, TI recommends inserting a current meter between the output voltage and the electronic load.
8. Connect a voltage meter to TP16 and TP17 to monitor the output voltage
9. Turn on the AC voltage source output.
10. Turn on the DC source output.

7.1 Equipment Shutdown

Shut down the equipment using the following steps:

1. Shut down the AC voltage source.
2. Shut down the DC voltage source.
3. Shut down the electronic load.

WARNING

High voltage may still be present after turning off the AC and DC sources. Use the electronic load to discharge the output capacitance before handling the EVM.

8 Performance Data and Typical Characteristic Curves

8.1 Standby Power

Table 4 lists the total standby power measurement. The electronic load is physically disconnected from J9 for this test. The average input power is measured at V_I and external V_{CC} over a five minute interval.

Table 4. Total Standby Power

INPUT VOLTAGE(V_{RMS})	INPUT POWER (mW)	VCC VOTALGE (V)	VCC CURRENT (μA)	TOTAL STANDBY POWER (mW)
85	17	12.00743	104.0338	18.22
115	21.3	12.01006	107.022	22.83
230	38.6	12.00832	105.630	39.84
265	47.9	12.00830	105.902	49.11

8.2 Efficiency

Figure 2 illustrates the EVM efficiency graph.

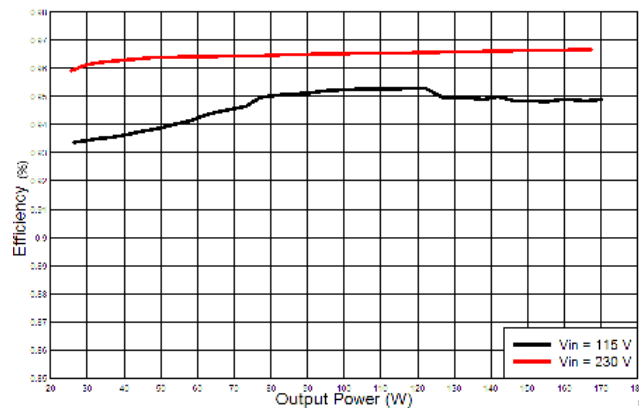

Figure 2. Efficiency

8.3 Load Regulation

Figure 3 illustrates the load regulation versus output power graph.

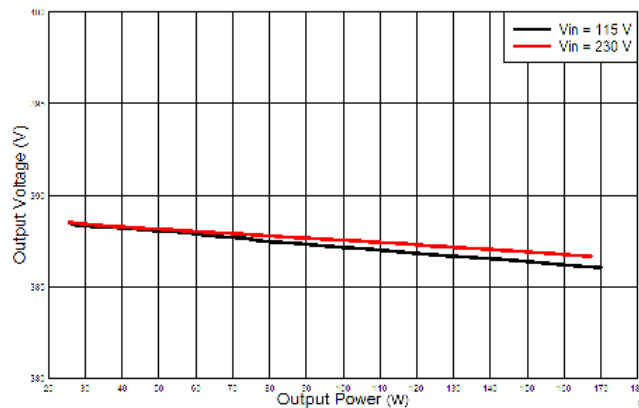

Figure 3. Load Regulation versus Output Power

8.4 Line Regulation

Figure 4 illustrates the line regulation versus input voltage graph.

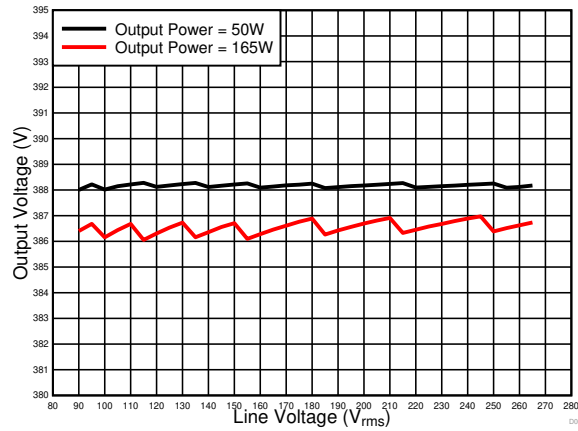

Figure 4. Line Regulation versus Input Voltage

8.5 Power Factor

Figure 5 illustrates the power factor versus output power graph.

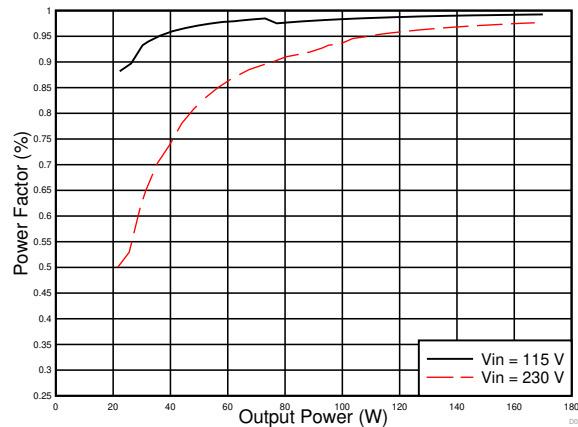

Figure 5. Power Factor versus Output Power

8.6 THD

Figure 6 illustrates the THD versus output power graph.

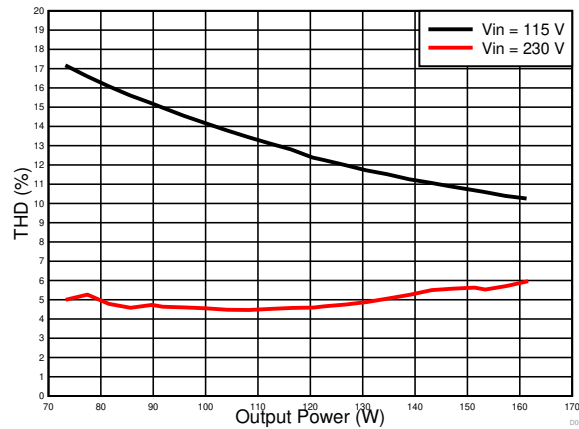

Figure 6. THD versus Output Power

8.7 Start-up

The following waveforms show the output voltage behavior when the line voltage has already been applied and the instant the VCC voltage exceeds the start-up threshold. From Figure 7 to Figure 13, Channel 1 = VCC, Channel 2 = input voltage, and Channel 3 = output voltage.



Figure 7. 85 VAC Start-up No Load

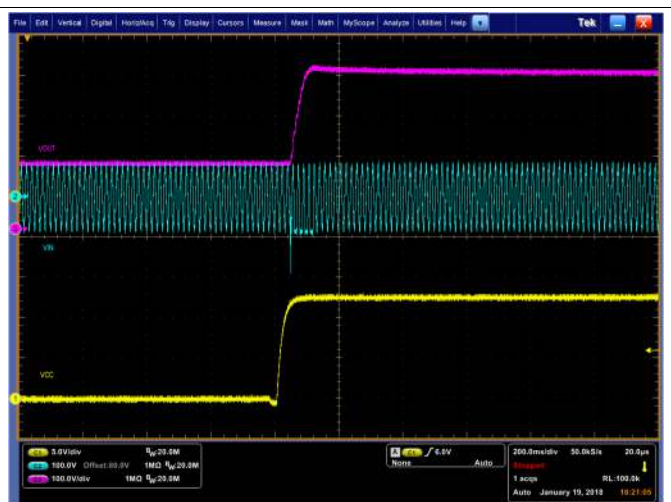

Figure 8. 115 VAC Start-up No Load

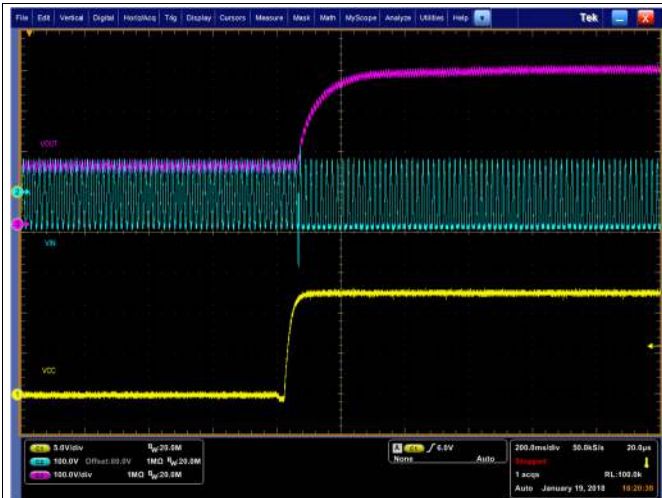

Figure 9. 115 VAC Start-up Full Load



Figure 10. 230 VAC Start-up No Load

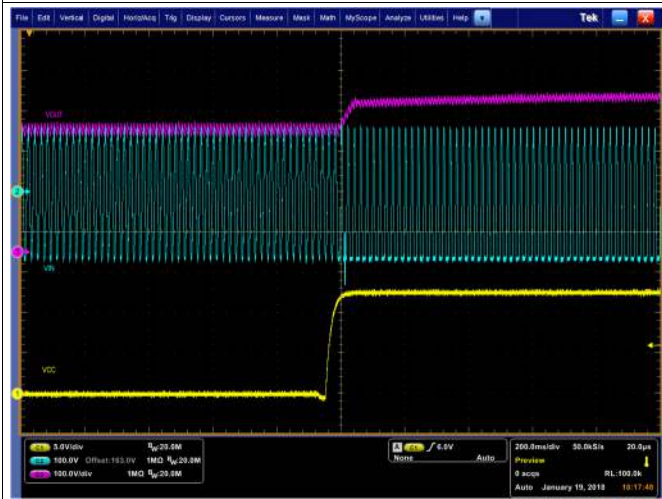

Figure 11. 230 VAC Start-up Full Load



Figure 12. 265 VAC Start-up No Load

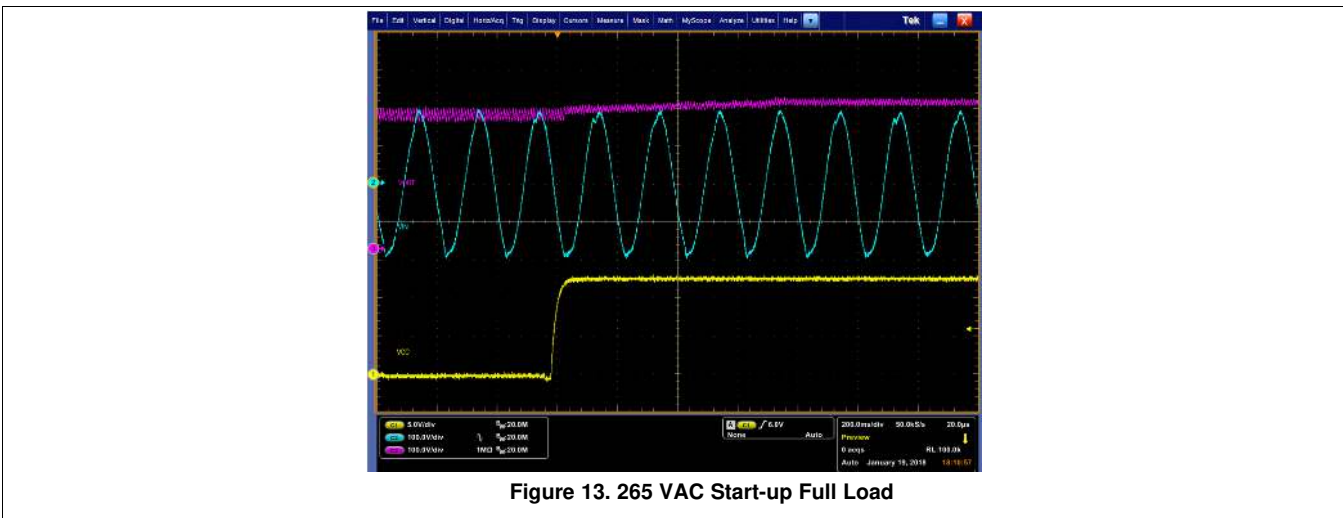

Figure 13. 265 VAC Start-up Full Load

8.8 Line Voltage and Line Current

Figure 14 and Figure 15 illustrate the low- and high-line voltage and current waveforms.

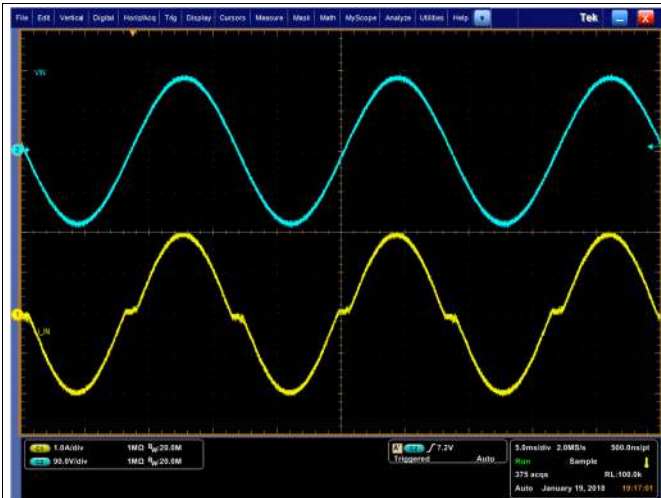

Figure 14. Low-Line Voltage and Current

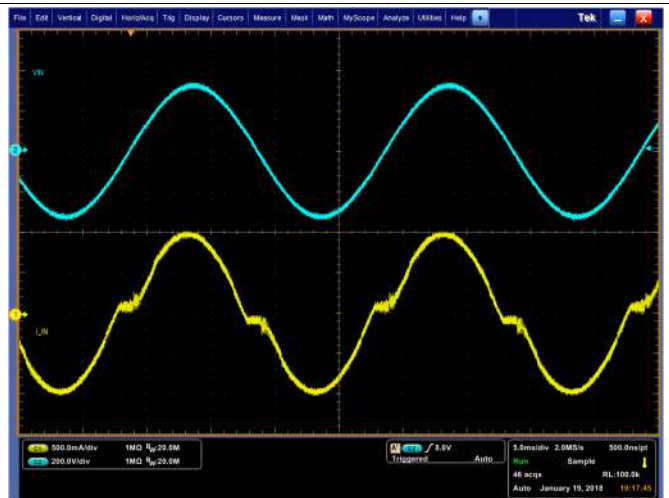

Figure 15. High-Line Voltage and Current

8.9 Valley Switching

The following waveforms show drain to source voltage of the MOSFET and the valley switching action on the EVM.



Figure 16. 85 VAC Valley Switching 50-mA Load



Figure 17. 115 VAC Valley Switching 50-mA Load



Figure 18. 230 VAC Valley Switching 100-mA Load



Figure 19. 265 VAC Valley Switching 100-mA Load

8.10 Voltage Stress Q1

Figure 20 illustrates the voltage stress Q1 waveform.



Figure 20. Q1 Max Vds Stress

8.11 Voltage Stress D4

Figure 21 illustrates the voltage stress D4 waveform.



Figure 21. D4 Max Voltage Stress

9 Schematic, Assembly Drawing and Bill of Materials

9.1 Schematic

Figure 22 illustrates the EVM schematic.

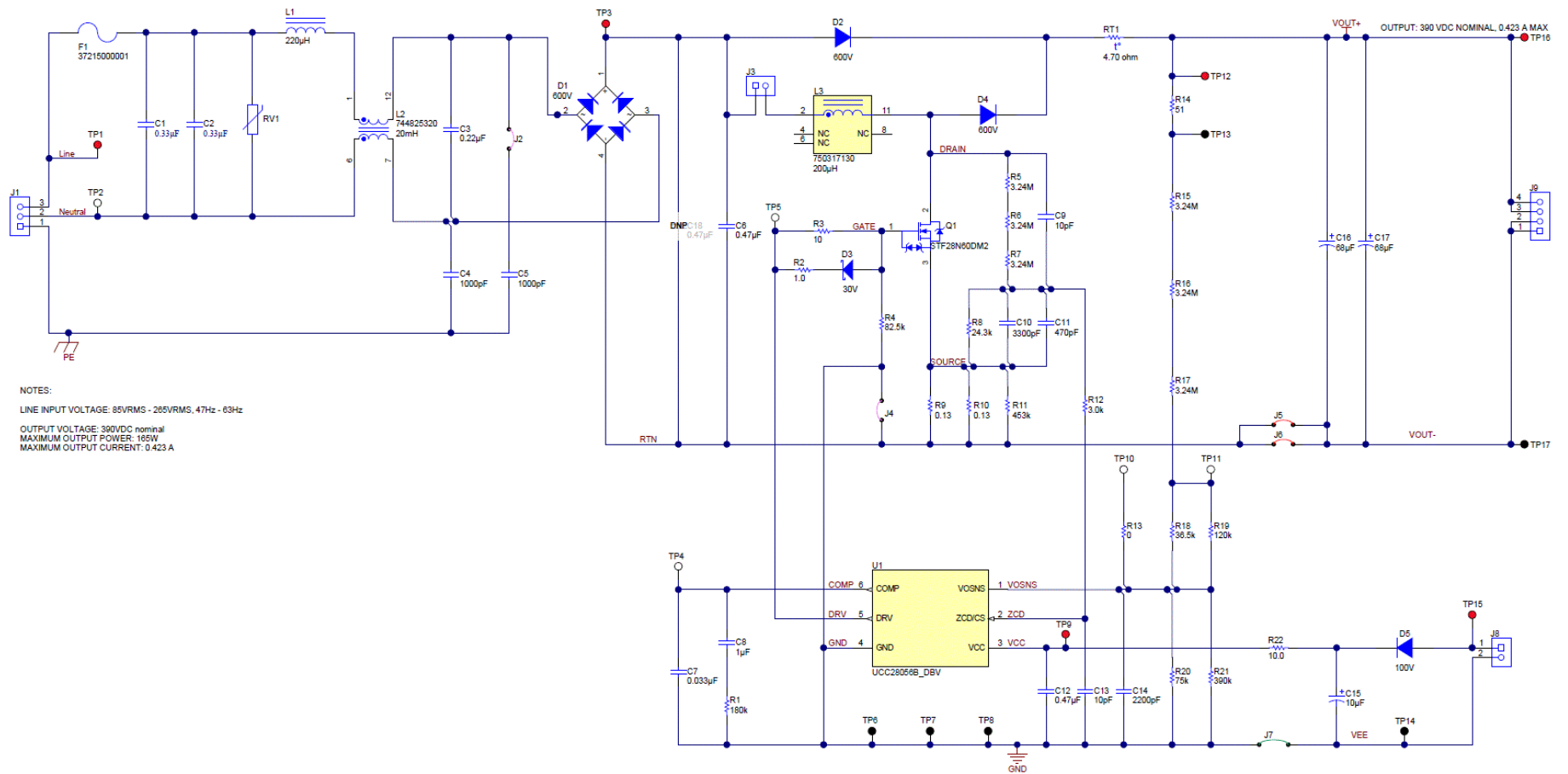

Figure 22. UCC28056BEVM-296 Schematic

9.2 Assembly Drawing

Figure 23 through Figure 26 illustrate the EVM assembly drawings.

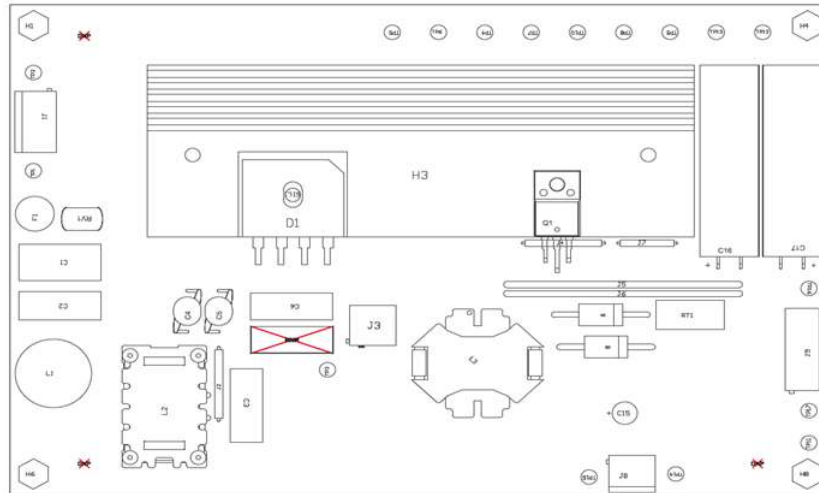

Figure 23. UCC28056BEVM-296 Top Assembly Drawing (Top view)



Figure 24. UCC28056BEVM-296 Bottom Layer Assembly Drawing (Top view)

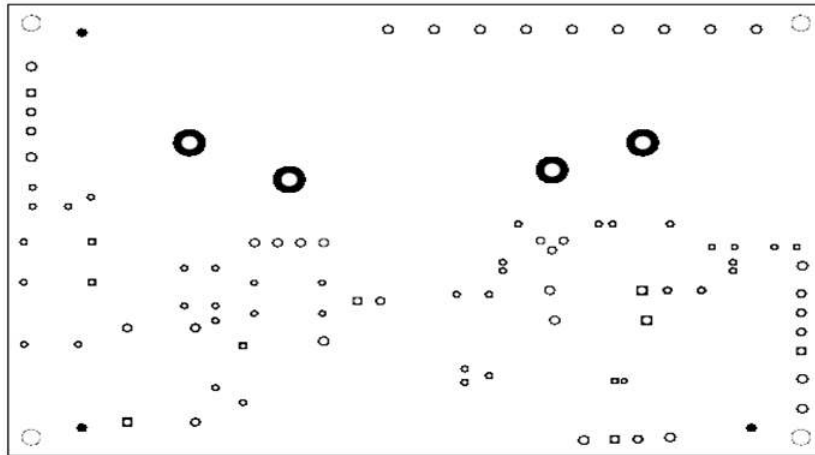

Figure 25. UCC28056BEVM-296 Top Copper Assembly Drawing (Top view)

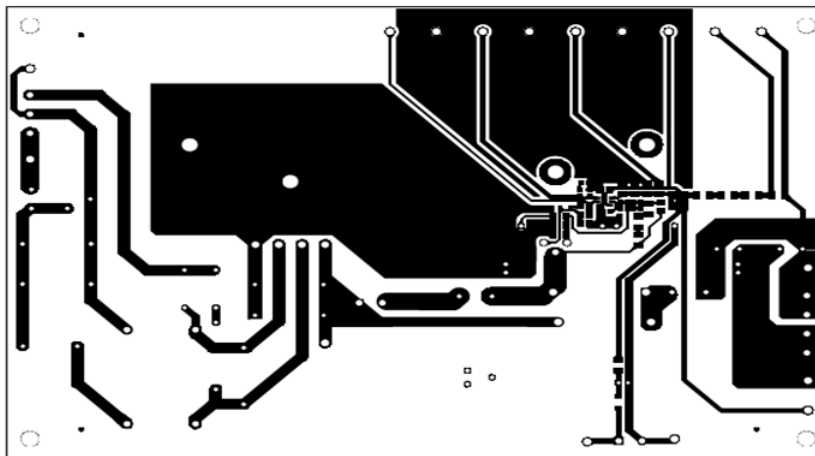

Figure 26. UCC28056BEVM-296 Bottom Copper Assembly Drawing (Top view)

9.3 Bill of Materials

Table 5 contains the EVM BOM.

Table 5. Bill of Materials

DESIGNATOR	QTY	VALUE	DESCRIPTION	PACKAGE REFERENCE	PART NUMBER
!PCB1	1		Printed Circuit Board		SV601296
C1, C2	2	0.33 μ F	CAP, Film, 0.33 μ F, 630 V, \pm 20%, TH	17.5x16.5x10 mm	BFC233841334
C3	1	0.22 μ F	CAP, Film, 0.22 μ F, 630 V, \pm 10%, TH	B32922_12.5 mm	B32922C3224K
C4, C5	2	1000 pF	CAP, CERM, 1000 pF, V, \pm 20%, E, D7xT6mm	D7xT6 mm	CD45-E2GA102M-NKA
C6	1	0.47 μ F	CAP, Film, 0.47 μ F, 450 V, \pm 5%, TH	18x6.5 mm	450MPK474J
C7	1	0.033 μ F	CAP, CERM, 0.033 μ F, 50 V, \pm 5%, X7R, 0603	0603	0603C333JAT2A
C8	1	1 μ F	CAP, CERM, 1 μ F, 25 V, \pm 10%, X7R, 0603	0603	0603C105KAT2A
C9	1	10 pF	CAP, CERM, 10 pF, 1000 V, \pm 5%, C0G/NP0, 0805	0805	VJ0805A100JXGAT5Z
C10	1	3300 pF	CAP, CERM, 3300 pF, 100 V, \pm 5%, NP0, 0603	0603	CGA3E2NP02A332J080AA
C11	1	470 pF	CAP, CERM, 470 pF, 100 V, \pm 5%, C0G/NP0, 0603	0603	GRM1885C2A471JA01D
C12	1	0.47 μ F	CAP, CERM, 0.47 μ F, 50 V, \pm 10%, X7R, 0805	0805	GRM21BR71H474KA88L
C13	1	10 pF	CAP, CERM, 10 pF, 10 V, \pm 10%, X7R, 0603	0603	0603ZC100KAT2A
C14	1	2200 pF	CAP, CERM, 2200 pF, 50 V, \pm 5%, C0G/NP0, 1206	1206	GRM3195C1H222JA01D
C15	1	10 μ F	CAP, AL, 10 μ F, 50 V, \pm 20%, TH	D5xL11 mm	EKMG500ELL100ME11D
C16, C17	2	68 μ F	CAP, AL, 68 μ F, 450 V, \pm 20%, TH	D12.5xL45 mm	450BXW68MEFC12.5X45
D1	1	600 V	Diode, P-N-Bridge, 600 V, 4 A, TH	GBU	GBU4J-BP
D2	1	600 V	Diode, Fast Rectifier, 600 V, 3 A, TH	DO-201AD	MR856G
D3	1	30 V	Diode, Schottky, 30 V, 0.35 A, SOD-323	SOD-323	BAT48JFILM
D4	1	600 V	Diode, Ultrafast, 600 V, 5 A, TH	DO-201AD	STTH5L06
D5	1	100 V	Diode, Switching, 100 V, 0.15 A, SOD-123FL	SOD-123FL	1N4148WFL-G3-08
F1	1		Fuse, 5 A, 250 VAC/VDC, TH	TR5 fuse 8.5 mm DIA	3721500001
H1, H4, H6, H8	4		HEX STANDOFF 6-32 NYLON 1-1/2"	HEX STANDOFF 6-32 NYLON 1-1/2 inch	4824
H2, H5, H7, H9	4		Standoff, Hex, 0.5"L #6-32 Nylon	6-32 HEX Nylon standoff 0.500 mil	1903C
H3	1		Custom HeatSink, 120x42x10 mm	HeatSink, 120x42x10 mm	FL12-013-120x42
H10, H11, H12	3		MACHINE SCREW PAN PHILLIPS, 5/16", 4-40		PMSSS 440 0031 PH
H13, H14, H15	3		Washer, Split Lock, #4		4693
H16	1		TO-220 Mounting Kit	TO-220 Mounting Kit	4880SG
H17, H18, H19	3		Nut, Hex, 1/4" Thick, #4-40		HNSS440
J1	1		Terminal Block, 5.08 mm, 3x1, Brass, TH	3x1 5.08 mm Terminal Block	ED120/3DS
J2, J4	2		Jumper Wire, 700 mil spacing, Violet, pkg of 150, TH	700 mil Jumper Wire	923345-07-C
J3	1		Terminal Block, 5.08 mm, 2x1, TH	2POS Terminal Block	1715721
J5, J6	2		Jumper Wire, 2" spacing, Red, pkg of 100, TH	Jumper Wire, 2" Spacing, Red, Pkg of 100	923345-20-C
J7	1		Jumper Wire, 500 mil spacing, Green, pkg of 200	500 mil Jumper Wire	923345-05-C
J8	1		Terminal Block, 5.08 mm, 2x1, Brass, TH	2x1 5.08 mm Terminal Block	ED120/2DS
J9	1		Terminal Block, 5.08 mm, 4x1, Brass, TH	4x1 5.08 mm Terminal Block	ED120/4DS
L1	1	220 μ H	Inductor, Wirewound, Ferrite, 220 μ H, 2.42 A, 0.168 Ω , TH	D630xH810mil	DC630R-224K
L2	1	20 mH	Coupled inductor, 20 mH, 3 A, 0.16 Ω , TH	30x35x21 mm	744825320
L3	1	200 μ H	Inductor, 200 μ H, 0.223 Ω , TH, RevA	TH, 5-Leads, Body 26.16x26.16 mm	750317130
Q1	1	600 V	MOSFET, N-CH, 600 V, 21 A, TO-220FP	TO-220FP	STF28N60DM2
R1	1	180 k	RES, 180 k, 5%, 0.1 W, 0603	0603	CRCW0603180KJNEA
R2	1	1.0	RES, 1.0, 5%, 0.125 W, 0805	0805	CRCW08051R00JNEA
R3	1	10	RES, 10, 5%, 0.125 W, 0805	0805	CRCW080510R0JNEA
R4	1	82.5 k	RES, 82.5 k, 1%, 0.125 W, 0805	0805	ERJ-6ENF8252V
R5, R6, R7, R15, R16, R17	6	3.24 Meg	RES, 3.24 M, 1%, 0.25 W, 1206	1206	CRCW12063M24FKEA
R8	1	24.3 k	RES, 24.3 k, 1%, 0.1 W, 0603	0603	CRCW060324K3FKEA
R9, R10	2	0.13	RES, 0.13, 1%, 0.5 W, 1206	1206	CSR1206FTR130
R11	1	453 k	RES, 453 k, 1%, 0.25 W, 1206	1206	CRCW1206453KFKEA
R12	1	3.0 k	RES, 3.0 k, 5%, 0.1 W, 0603	0603	CRCW06033K00JNEA

Table 5. Bill of Materials (continued)

DESIGNATOR	QTY	VALUE	DESCRIPTION	PACKAGE REFERENCE	PART NUMBER
R13	1	0	RES, 0, 5%, 0.25 W, 1206	1206	CRCW1206000Z0EA
R14	1	51	RES, 51, 5%, 0.25 W, 1206	1206	CRCW120651R0JNEA
R18	1	36.5 k	RES, 36.5 k, 1%, 0.25 W, 1206	1206	CRCW120636K5FKEA
R19	1	120 k	RES, 120 k, 5%, 0.25 W, 1206	1206	CRCW1206120KJNEA
R20	1	75 k	RES, 75 k, 5%, 0.25 W, 1206	1206	CRCW120675K0JNEA
R21	1	390 k	RES, 390 k, 5%, 0.25 W, 1206	1206	CRCW1206390KJNEA
R22	1	10.0	RES, 10.0, 1%, 0.25 W, 1206	1206	CRCW120610R0FKEA
RT1	1	4.70 Ω	Thermistor NTC, 4.70 Ω , 20%, 8.5 mm Disc	8.5mm Disc	B57153S0479M000
RV1	1		VARISTOR 490 V 1.2KA DISC 7MM	Dia. 7 mm	V300LA2P
SIL1	1		Silicon Thermal Pad	24x21 mm	SP900S-0.009-00-114
TP1, TP3, TP9, TP12, TP15, TP16	6		Test Point, Multipurpose, Red, TH	Red Multipurpose Testpoint	5010
TP2, TP4, TP5, TP10, TP11	5		Test Point, Multipurpose, White, TH	White Multipurpose Testpoint	5012
TP6, TP7, TP8, TP13, TP14, TP17	6		Test Point, Multipurpose, Black, TH	Black Multipurpose Testpoint	5011
U1	1		6-Pin Single-Phase Transition-Mode PFC Controller, DBV0006A (SOT-23-6)	DBV0006A	UCC28056B_DBV
C18	0	0.47 μ F	CAP, Film, 0.47 μ F, 450 V, \pm 5%, TH	18x6.5 mm	450MPK474J

Revision History

NOTE: Page numbers for previous revisions may differ from page numbers in the current version.

Changes from B Revision (April 2018) to C Revision	Page
• Changed Figure 22 to reflect new boost inductance	1
• Added how to use UCC28056A in the Section 2.3 section	4
• Added how to use UCC28056B and UCC28056C in the Section 2.4 section	5
• Changed Table 4 to reflect UCC28056B	10
• Changed Figure 2 to reflect UCC28056B	10
• Changed Figure 3 to reflect UCC28056B	10
• Changed Figure 4 to reflect UCC28056B	11
• Changed Figure 5 to reflect UCC28056B	11
• Changed Figure 6 to reflect UCC28056B	11
• Changed Figure 22 to reflect new boost inductance	17
• Changed boost inductor value in Table 5	20

Changes from A Revision (January 2018) to B Revision	Page
• Removed the Advanced Information statement	2
• Corrected part number for L3 in Figure 22	17

Changes from Original (October 2017) to A Revision	Page
• Updated graphs and waveforms in Section 8	10
• Added Standby Power section.	10
• Added Startup section.	12
• Added Valley Switching section.	14
• Moved C2 in the bill of materials.	20
• Changed the Q1 part number in the bill of materials.	20
• Changed parameters on RT1 in the bill of materials.	20

IMPORTANT NOTICE AND DISCLAIMER

TI PROVIDES TECHNICAL AND RELIABILITY DATA (INCLUDING DATA SHEETS), DESIGN RESOURCES (INCLUDING REFERENCE DESIGNS), APPLICATION OR OTHER DESIGN ADVICE, WEB TOOLS, SAFETY INFORMATION, AND OTHER RESOURCES "AS IS" AND WITH ALL FAULTS, AND DISCLAIMS ALL WARRANTIES, EXPRESS AND IMPLIED, INCLUDING WITHOUT LIMITATION ANY IMPLIED WARRANTIES OF MERCHANTABILITY, FITNESS FOR A PARTICULAR PURPOSE OR NON-INFRINGEMENT OF THIRD PARTY INTELLECTUAL PROPERTY RIGHTS.

These resources are intended for skilled developers designing with TI products. You are solely responsible for (1) selecting the appropriate TI products for your application, (2) designing, validating and testing your application, and (3) ensuring your application meets applicable standards, and any other safety, security, regulatory or other requirements.

These resources are subject to change without notice. TI grants you permission to use these resources only for development of an application that uses the TI products described in the resource. Other reproduction and display of these resources is prohibited. No license is granted to any other TI intellectual property right or to any third party intellectual property right. TI disclaims responsibility for, and you will fully indemnify TI and its representatives against, any claims, damages, costs, losses, and liabilities arising out of your use of these resources.

TI's products are provided subject to [TI's Terms of Sale](#) or other applicable terms available either on ti.com or provided in conjunction with such TI products. TI's provision of these resources does not expand or otherwise alter TI's applicable warranties or warranty disclaimers for TI products.

TI objects to and rejects any additional or different terms you may have proposed.

Mailing Address: Texas Instruments, Post Office Box 655303, Dallas, Texas 75265
Copyright © 2022, Texas Instruments Incorporated