

# SD1420

## Silicon Photodiode

### FEATURES

- Compact, metal can coaxial package
- 24° (nominal) acceptance angle
- Wide operating temperature range (-55°C to +125°C)
- Mechanically and spectrally matched to SE1450 and SE1470 infrared emitting diodes

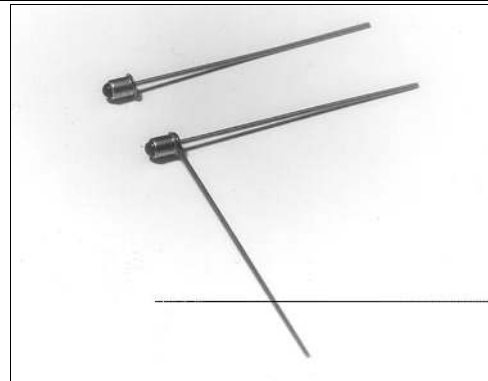

INFRA-63.TIF

### DESCRIPTION

The SD1420 is a PN junction silicon photodiode mounted in a glass lensed metal can coaxial package. The package may have a tab or second lead welded to the can as an optional feature (SD1420-XXXL). Both leads are flexible and may be formed as required to fit various mounting configurations.

### OUTLINE DIMENSIONS in inches (mm)

Tolerance 3 plc decimals ±0.005(0.12)  
2 plc decimals ±0.020(0.51)

#### SD1420-XXX

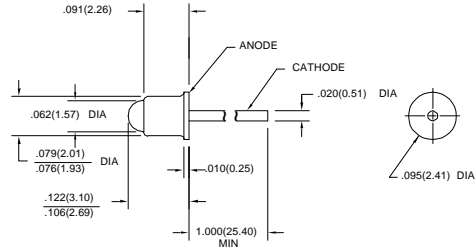

DIM\_10a.ds4

#### SD1420-XXXL

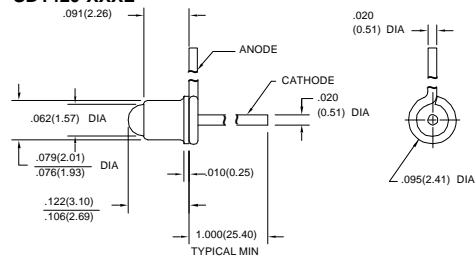

DIM\_10b.ds4

# SD1420

## Silicon Photodiode

### ELECTRICAL CHARACTERISTICS (25°C unless otherwise noted)

PARAMETER	SYMBOL	MIN	TYP	MAX	UNITS	TEST CONDITIONS
Light Current SD1420-002, SD1420-002L	$I_L$	5.0			$\mu\text{A}$	$V_R=20\text{ V}$ $H=5\text{ mW/cm}^2$ (1)
Dark Current	$I_D$			5.0	nA	$V_R=20\text{ V}$ $H=0$
Reverse Breakdown Voltage	$V_{BR}$	50			V	$I_R=10\ \mu\text{A}$
Angular Response (2)	$\emptyset$		24		degr.	$I_F=\text{Constant}$
Rise And Fall Time	$t_r, t_f$		50		ns	$V_R=20\text{ V}$ $R_L=50\ \Omega$

#### Notes

1. The radiation source is a tungsten lamp operating at a color temperature of 2870°K.
2. Angular response is defined as the total included angle between the half sensitivity points.

### ABSOLUTE MAXIMUM RATINGS

(25°C Free-Air Temperature unless otherwise noted)

Cathode Anode Voltage	50 V
Power Dissipation	75 mW (1)
Operating Temperature Range	-55°C to 125°C
Storage Temperature Range	-65°C to 150°C
Soldering Temperature (10 sec)	260°C

#### Notes

1. Derate linearly from 25°C free-air temperature at the rate of 0.71 mW/°C.

### SCHEMATIC

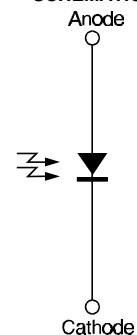

Honeywell reserves the right to make changes in order to improve design and supply the best products possible.

# Honeywell

# SD1420

## Silicon Photodiode

### SWITCHING TIME TEST CIRCUIT

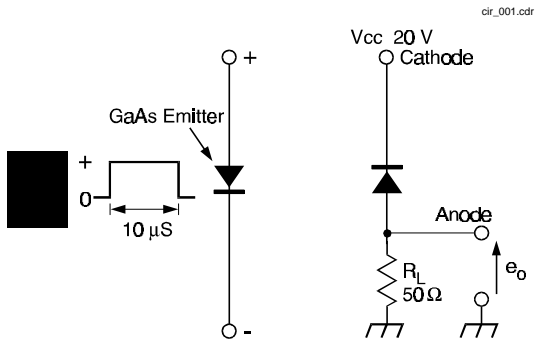

Fig. 1 Responsivity vs Angular Displacement

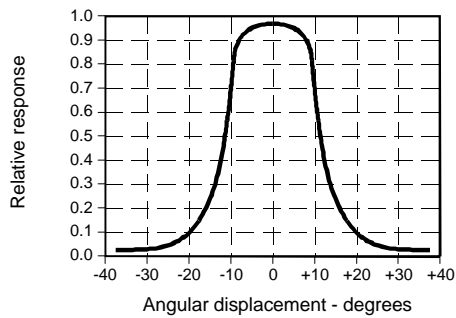
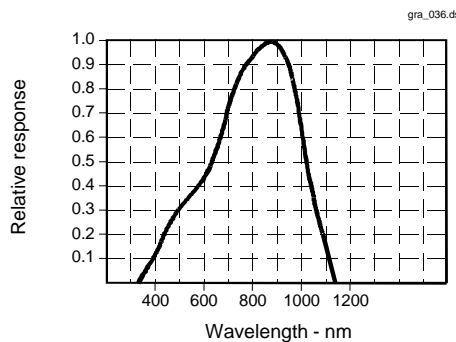

Fig. 3 Spectral Responsivity



All Performance Curves Show Typical Values

### SWITCHING WAVEFORM

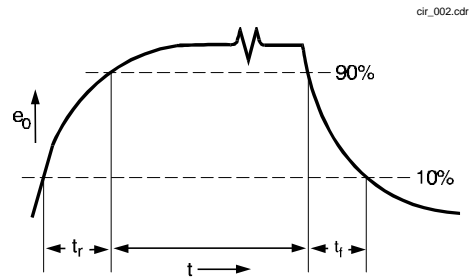
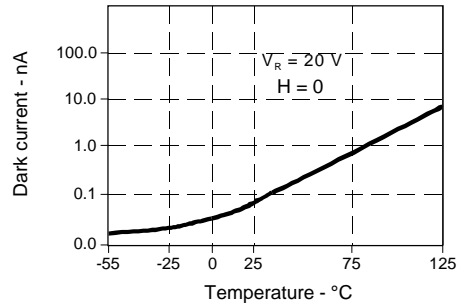

Fig. 2 Dark Current vs Temperature



**SD1420**  
Silicon Photodiode

---



Honeywell reserves the right to make changes in order to improve design and supply the best products possible.

**Honeywell**