

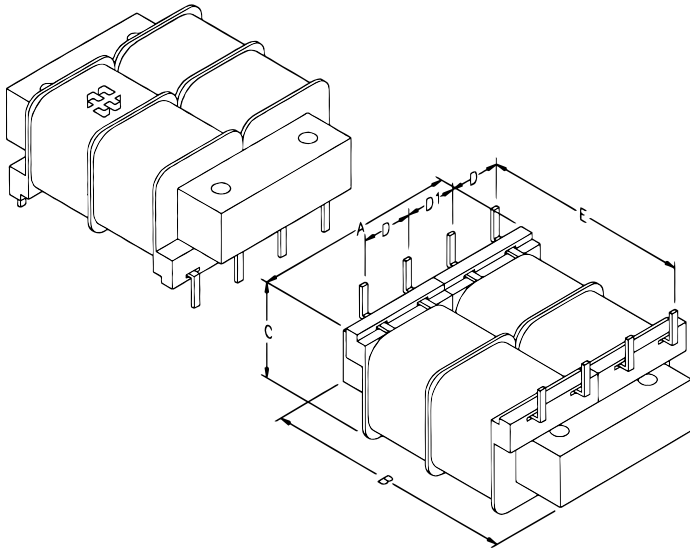

Power Transformer - Dual Primary Low Voltage PC Board Mount - Low Profile



Features

- Low profile mounting, dual - split bobbin design.
- Low primary to secondary coupling, balanced windings, no electrostatic shield required and low EMF radiation due to semi-toroidal design.
- Universal dual primary 115/230V - 50/60 Hz.
- High insulation - Hipot of 1,750V RMS.
- Class B insulation - 130 degrees C.
- C UL US recognized.

Connection Information - 229 Series Transformers

Mechanical	
A	1.56" (40 mm)
B	1.88" (48 mm)
C	0.65" (17 mm)
D	0.38" (10 mm)
D1	0.38" (10 mm)
E	1.60" (41 mm)
PC Board Spacing	0.75" (19 mm)
Pin Size	0.02" x 0.04" (1 mm x 1 mm)
Electrical	
Size (VA)	2
Primary	115 /230V, 50 /60Hz
Secondary (RMS) Series	40V C.T. @ 60ma
Secondary (RMS) Parallel	20V @ 120ma
Regulation	30%

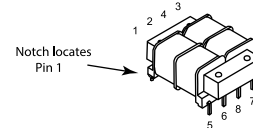

Primary Connections - 229 Series Transformers

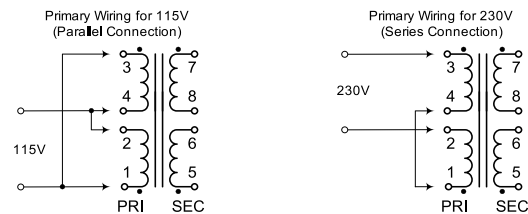

Secondary Connections - 229 Series Transformers

