

High Power LED Series
3535 Ceramic Hot Binning

LH351B

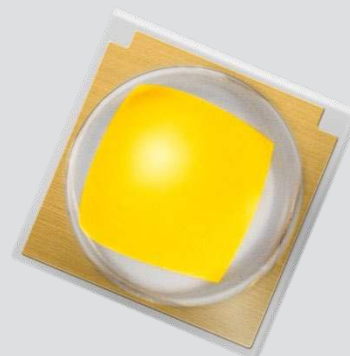

High efficacy and high quality color rendering makes the LH351B suitable use in a broad range of applications

Features & Benefits

- Operates at a maximum current of up to 1.5 A
- Uniform light distribution under any beam angle
- 80 CRI makes it well suited for most applications
- Hot binning @ 85 °C
- Completed 10,000 hours of LM-80 testing @ 1 A, 105 °C

Applications

- Indoor Lighting: Spotlight, Downlight
- Outdoor Lighting: Street Light, Tunnel Light, Security Light, Parking Lot Light
- Industrial Lighting: High Bay Light, Low Bay Light
- Consumer Lighting: Torch Light



Table of Contents

1.	Characteristics	-----	3
2.	Product Code Information	-----	6
3.	Typical Characteristics Graphs	-----	16
4.	Outline Drawing & Dimension	-----	18
5.	Reliability Test Items & Conditions	-----	19
6.	Soldering Conditions	-----	20
7.	Tape & Reel	-----	21
8.	Label Structure	-----	23
9.	Packing Structure	-----	24
10.	Precautions in Handling & Use	-----	26

1. Characteristics

a) Absolute Maximum Rating

Item	Symbol	Rating	Unit	Condition
Operating Temperature	T_{opr}	-40 ~ +105	°C	Note 1)*
Storage Temperature	T_{stg}	-40 ~ +120	°C	-
LED Junction Temperature	T_j	150	°C	-
Forward Current	I_F	1500	mA	-
Peak Pulse Forward Current	I_{FP}	2000	mA	Duty 1/10 pulse width 10ms
Assembly Process Temperature		260 <10	°C s	-
ESD (HBM)	-	±8	kV	-

Notes:

- 1) Refer to the derating curve, '3. Typical Characteristics Graph', for proper driving current that maintained below maximum junction temperature.

b) Electro-optical Characteristics

Item	Unit	Condition		Value		
		I _F (mA)	T _J (°C)	Min	Typ	Max
Forward voltage	V	350	85	2.5		3.0
Reverse Voltage (@ 5 mA)	V		25	14		19.5
Thermal Resistance (junction to solder point)	°C/W		25		4	
Beam Angle	°	350	25		120	

Notes:

- 1) Samsung maintains measurement tolerance of: luminous flux = $\pm 7\%$, forward voltage = ± 0.1 V
- 2) Characteristics @ 25 °C are for reference only

c) Luminous Flux Characteristics (T_j = 85 °C)

Sorting @ 350 mA (lm)			Calculated Minimum Flux ²⁾ (lm)			
Flux Rank	Flux Range ¹⁾	Sub Rank	@ 350 mA	@ 700 mA	@ 1050 mA	@ 1500 mA
F3	90 ~ 120	F1, G1, H1	90	163	214	289
G3	100 ~ 130	G1, H1, 1B	100	181	238	322
H3	110 ~ 140	H1, J1, K1	110	199	262	354
J3	120 ~ 150	J1, K1, M1	120	217	286	386
K3	130 ~ 160	K1, M1, N1	130	235	310	418
M3	140 ~ 170	M1, N1, P1	135	250	354	474
N3	150 ~ 180	N1, P1, Q1	150	270	359	489
P3	160 ~ 190	P1, Q1, R1	160	288	382	518
Q2	170 ~ 190	Q1, R1	170	306	405	545
Q3	170 ~ 200	Q1, R1, S1	170	306	405	545

Notes:

- 1) Samsung maintains measurement tolerance of: luminous flux = ±7 %, CRI = ±3
- 2) Calculated minimum flux values are for reference only

2. Product Code Information

1	2	3	4	5	6	7	8	9	10	11	12	13	14	15	16	17	18																																																																																																																																																																																																						
S	P	H	W	H	2	L	3	D	3	0	E	D	4	V	0	K	3																																																																																																																																																																																																						
Digit		PKG Information			Code		Specification																																																																																																																																																																																																																
1 2 3		Samsung Package High Power			SPH																																																																																																																																																																																																																		
4 5		Color			WH		White																																																																																																																																																																																																																
6		Product Version			2																																																																																																																																																																																																																		
7 8		Product			L3		LH351 Series																																																																																																																																																																																																																
9		Lens Type			D		Dome lens																																																																																																																																																																																																																
10		Internal Code			3																																																																																																																																																																																																																		
11		Not Defined			0		Default																																																																																																																																																																																																																
12		CRI & Sorting Temperature			C E G		Min. 70 Min. 80 85℃ Min. 90																																																																																																																																																																																																																
13 14		Forward Voltage (V)			D 4		2.5~3.0 Bin Code: D2 2.5~2.8 F2 2.8~3.0																																																																																																																																																																																																																
15 16		CCT (K)			Y☆ W☆ V☆ U☆ T☆ R◇ Q◇ P Q P◇		2200 Y1, Y2, Y3, Y4, Y5, Y6, Y7, Y8, Y9, YA, YB, YC, YD, YE, YF, YG, YM 2700 W1, W2, W3, W4, W5, W6, W7, W8, W9, WA, WB, WC, WD, WE, WF, WG, WM 3000 V1, V2, V3, V4, V5, V6, V7, V8, V9, VA, VB, VC, VD, VE, VF, VG, VM 3500 U1, U2, U3, U4, U5, U6, U7, U8, U9, UA, UB, UC, UD, UE, UF, UG, UM 4000 T1, T2, T3, T4, T5, T6, T7, T8, T9, TA, TB, TC, TD, TE, TF, TG, TM 5000 Bin Code: R1, R2, R3, R4 5700 Q1, Q2, Q3, Q4 6000 P2, Q1, P4, Q3 6500 P1, P2, P3, P4																																																																																																																																																																																																																
					☆ : "0" (Whole bin), "P" (Quarter bin), or "M" (MacAdam 3-step ellipse bin) ◇ : "T" (Half bin), or "N" (MacAdam 5-step ellipse bin)																																																																																																																																																																																																																		
17 18		Luminous Flux (lm)			F 3 G 3 H 3 J 3 K 3 M 3 N 3 P 3 Q 2 Q 3		<table border="1"> <tr> <td>90~120</td><td>F1</td><td>90~100</td><td>F 3</td><td></td><td></td><td></td><td></td><td></td><td></td><td></td><td></td><td></td><td></td><td></td><td></td><td></td><td></td> </tr> <tr> <td>100~130</td><td>G1</td><td>100~110</td><td></td><td>G 3</td><td></td><td></td><td></td><td></td><td></td><td></td><td></td><td></td><td></td><td></td><td></td><td></td><td></td> </tr> <tr> <td>110~140</td><td>H1</td><td>110~120</td><td></td><td></td><td>H 3</td><td></td><td></td><td></td><td></td><td></td><td></td><td></td><td></td><td></td><td></td><td></td><td></td> </tr> <tr> <td>120~150</td><td>J1</td><td>120~130</td><td></td><td></td><td></td><td>J 3</td><td></td><td></td><td></td><td></td><td></td><td></td><td></td><td></td><td></td><td></td><td></td> </tr> <tr> <td>130~160</td><td>K1</td><td>130~140</td><td></td><td></td><td></td><td></td><td>K 3</td><td></td><td></td><td></td><td></td><td></td><td></td><td></td><td></td><td></td><td></td> </tr> <tr> <td>140~170</td><td>M1</td><td>140~150</td><td></td><td></td><td></td><td></td><td></td><td>M 3</td><td></td><td></td><td></td><td></td><td></td><td></td><td></td><td></td><td></td> </tr> <tr> <td>150~180</td><td>N1</td><td>150~160</td><td></td><td></td><td></td><td></td><td></td><td></td><td>N 3</td><td></td><td></td><td></td><td></td><td></td><td></td><td></td><td></td> </tr> <tr> <td>160~190</td><td>P1</td><td>160~170</td><td>P 3</td><td></td><td></td><td></td><td></td><td></td><td></td><td></td><td></td><td></td><td></td><td></td><td></td><td></td><td></td> </tr> <tr> <td>170~190</td><td>Q1</td><td>170~180</td><td></td><td>Q 2</td><td></td><td></td><td></td><td></td><td></td><td></td><td></td><td></td><td></td><td></td><td></td><td></td><td></td> </tr> <tr> <td>170~200</td><td>R1</td><td>180~190</td><td></td><td></td><td>Q 3</td><td></td><td></td><td></td><td></td><td></td><td></td><td></td><td></td><td></td><td></td><td></td><td></td> </tr> <tr> <td></td><td>S1</td><td>190~200</td><td></td><td></td><td></td><td></td><td></td><td></td><td></td><td></td><td></td><td></td><td></td><td></td><td></td><td></td><td></td> </tr> </table>											90~120	F1	90~100	F 3															100~130	G1	100~110		G 3														110~140	H1	110~120			H 3													120~150	J1	120~130				J 3												130~160	K1	130~140					K 3											140~170	M1	140~150						M 3										150~180	N1	150~160							N 3									160~190	P1	160~170	P 3															170~190	Q1	170~180		Q 2														170~200	R1	180~190			Q 3														S1	190~200															
90~120	F1	90~100	F 3																																																																																																																																																																																																																				
100~130	G1	100~110		G 3																																																																																																																																																																																																																			
110~140	H1	110~120			H 3																																																																																																																																																																																																																		
120~150	J1	120~130				J 3																																																																																																																																																																																																																	
130~160	K1	130~140					K 3																																																																																																																																																																																																																
140~170	M1	140~150						M 3																																																																																																																																																																																																															
150~180	N1	150~160							N 3																																																																																																																																																																																																														
160~190	P1	160~170	P 3																																																																																																																																																																																																																				
170~190	Q1	170~180		Q 2																																																																																																																																																																																																																			
170~200	R1	180~190			Q 3																																																																																																																																																																																																																		
	S1	190~200																																																																																																																																																																																																																					
					Digit 17: Min. spec. Digit 18: The number of higher bin(s) from min. spec. e.g.: K1 = 130~140 lm, K3 = 130~160 lm																																																																																																																																																																																																																		

a) Luminous Flux Bins ($I_f = 350 \text{ mA}$, $T_j = 85 \text{ }^\circ\text{C}$)

CRI/ Nominal CCT (K)	Flux rank												
	E1	F1	G1	H1	J1	K1	M1	N1	P1	Q1	R1	S1	
	(min. flux)	80	90	100	110	120	130	140	150	160	170	180	190
2200						SPHWH2L3D30CD4Y ☆K3							
						SPHWH2L3D30CD4W ☆K3							
2700						SPHWH2L3D30CD4V ☆M3							
									SPHWH2L3D30CD4U ☆N3				
3000						SPHWH2L3D30CD4V ☆M3							
									SPHWH2L3D30CD4U ☆N3				
3500						SPHWH2L3D30CD4U ☆K3							
						SPHWH2L3D30CD4U ☆M3							
4000									SPHWH2L3D30CD4U ☆N3				
									SPHWH2L3D30CD4T ☆N3				
4500									SPHWH2L3D30CD4T ☆P3				
									SPHWH2L3D30CD4T ☆P3				
5000												SPHWH2L3D30CD4T ☆Q2	
												SPHWH2L3D30CD4T ☆Q3	
5500						SPHWH2L3D30CD4R ◇M3							
									SPHWH2L3D30CD4R ◇N3				
6000									SPHWH2L3D30CD4R ◇P3				
												SPHWH2L3D30CD4R ◇Q2	
6500												SPHWH2L3D30CD4R ◇Q3	
									SPHWH2L3D30CD4Q ◇N3				
7000									SPHWH2L3D30CD4Q ◇P3				
												SPHWH2L3D30CD4Q ◇Q2	
7500												SPHWH2L3D30CD4Q ◇Q3	
									SPHWH2L3D30CD4P ◇N3				
8000												SPHWH2L3D30CD4P ◇P3	

"☆" can be "0" (Whole bin), "P" (Quarter bin), or "M" (MacAdam 3-step ellipse bin) of the color binning

"◇" can be "T" (Half bin), or "N" (MacAdam 5-step ellipse bin) of the color binning

a) Luminous Flux Bins ($I_f = 350 \text{ mA}$, $T_j = 85 \text{ °C}$)

CRI/ Nominal CCT (K)	Flux rank												
	E1	F1	G1	H1	J1	K1	M1	N1	P1	Q1	R1	S1	
80	80	90	100	110	120	130	140	150	160	170	180	190	
2200			SPHWH2L3D30ED4Y ☆G3										
2700				SPHWH2L3D30ED4W ☆J3									
					SPHWH2L3D30ED4W ☆K3								
3000					SPHWH2L3D30ED4V ☆J3								
						SPHWH2L3D30ED4V ☆K3							
							SPHWH2L3D30ED4V ☆M3						
3500						SPHWH2L3D30ED4U ☆K3							
							SPHWH2L3D30ED4U ☆M3						
4000						SPHWH2L3D30ED4T ☆K3							
80							SPHWH2L3D30ED4T ☆M3						
5000								SPHWH2L3D30ED4R ◇M3					
								SPHWH2L3D30ED4R ◇N3					
5700								SPHWH2L3D30ED4Q ◇M3					
								SPHWH2L3D30ED4Q ◇N3					
6000						SPHWH2L3D30ED4PQK3							
							SPHWH2L3D30ED4PQM3						
							SPHWH2L3D30ED4PQN3						
6500							SPHWH2L3D30ED4P ◇K3						
							SPHWH2L3D30ED4P ◇M3						
								SPHWH2L3D30ED4P ◇N3					

"☆" can be "0" (Whole bin), "P" (Quarter bin), or "M" (MacAdam 3-step ellipse bin) of the color binning

"◇" can be "T" (Half bin), or "N" (MacAdam 5-step ellipse bin) of the color binning

a) Luminous Flux Bins ($I_f = 350 \text{ mA}$, $T_j = 85 \text{ }^\circ\text{C}$)

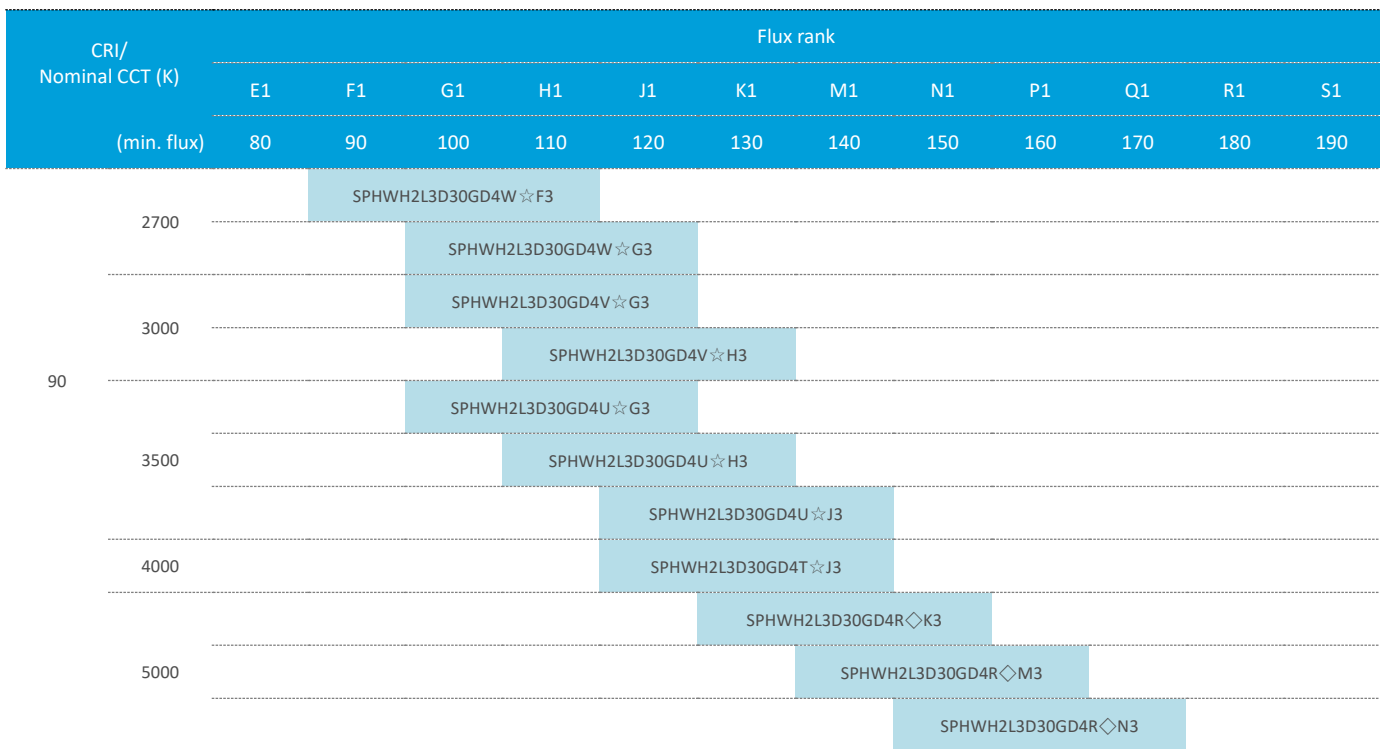

"☆" can be "0" (Whole bin), "P" (Quarter bin), or "M" (MacAdam 3-step ellipse bin) of the color binning

"◇" can be "T" (Half bin), or "N" (MacAdam 5-step ellipse bin) of the color binning

b) Color Bins (I_F = 350 mA, T_j = 85 °C)

Nominal CCT (K)	CRI (R _a)	Color Rank	Chromaticity Bins
2200	70, 80	☆0 (Whole bin)	1, 2, 3, 4, 5, 6, 7, 8, 9, A, B, C, D, E, F, G
		☆P (Quarter bin)	6, 7, A, B
		☆M (MacAdam 3-step)	MacAdam 3-step
2700, 3000, 3500	70, 80, 90	☆0 (Whole bin)	1, 2, 3, 4, 5, 6, 7, 8, 9, A, B, C, D, E, F, G
		☆P (Quarter bin)	6, 7, A, B
		☆M (MacAdam 3-step)	MacAdam 3-step
4000	70, 80	☆0 (Whole bin)	1, 2, 3, 4, 5, 6, 7, 8, 9, A, B, C, D, E, F, G
		☆P (Quarter bin)	6, 7, A, B
		☆M (MacAdam 3-step)	MacAdam 3-step
4000	90	☆0 (Whole bin)	1, 2, 3, 4, 5, 6, 7, 8, 9, A, B, C, D, E, F, G
		☆P (Quarter bin)	6, 7, A, B
5000	70, 80, 90	☆T (Half bin)	1, 2, 3, 4
		☆N (MacAdam 5-step)	MacAdam 5-step
		☆T (Half bin)	1, 2, 3, 4
5700, 6500	70, 80	☆N (MacAdam 5-step)	MacAdam 5-step
		☆T (Half bin)	1, 2, 3, 4
6000	80	☆T (Half bin)	1, 2, 3, 4

c) Voltage Bins (I_F = 350 mA, T_j = 85 °C)

Nominal CCT (K)	CRI (R _a) Min.	Product Code	Voltage Rank	Voltage Bin	Voltage Range (V)
-	-	-	D4	D2	2.5 ~ 2.8
-	-	-	-	F2	2.8 ~ 3.0

d) Chromaticity Region & Coordinates ($I_f = 350 \text{ mA}$, $T_j = 85 \text{ }^\circ\text{C}$)

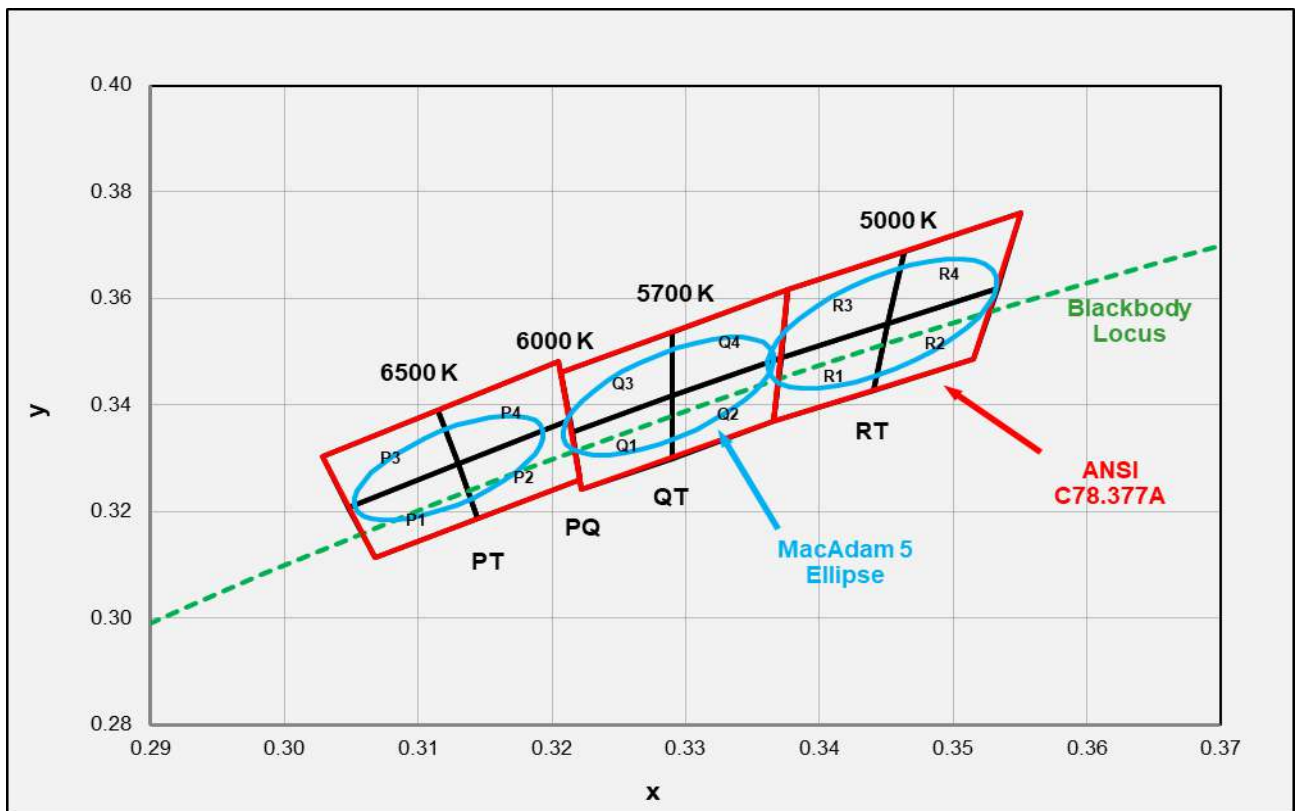
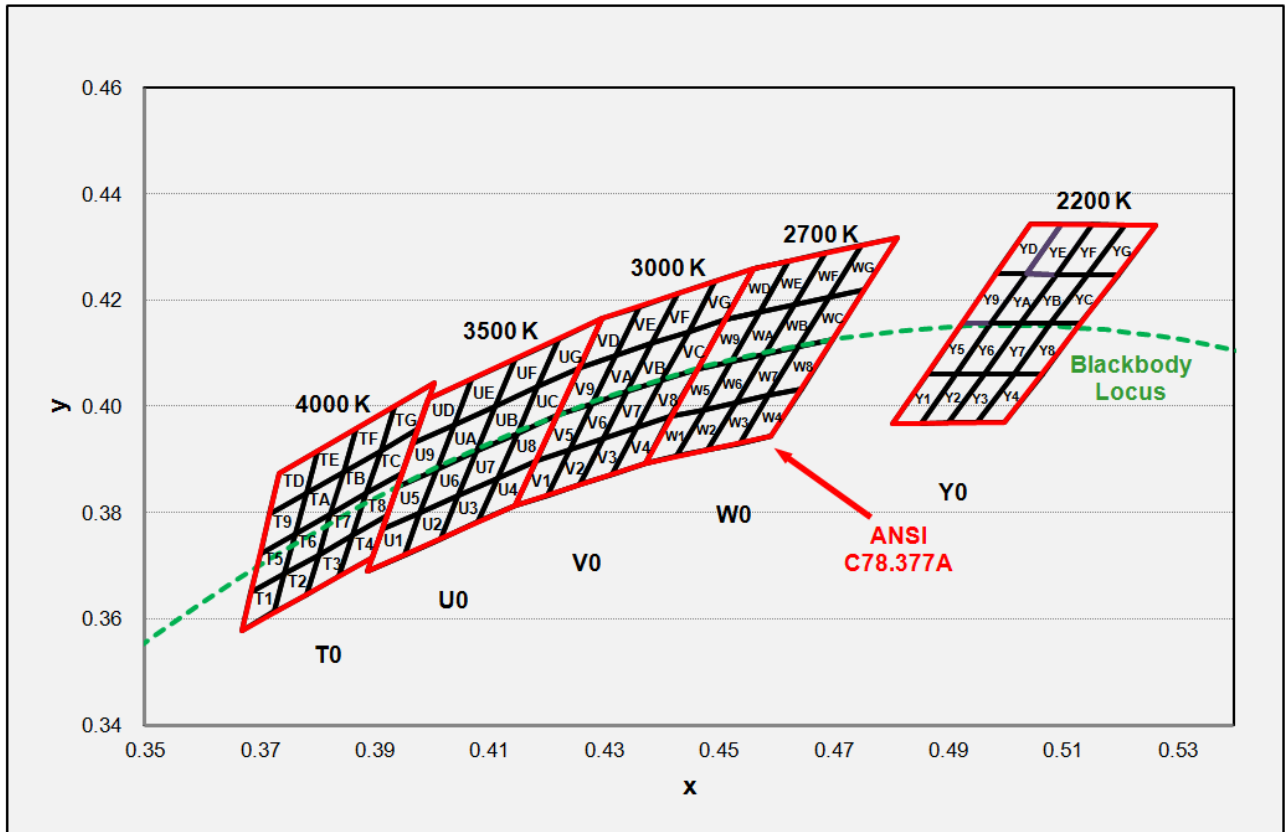

d) Chromaticity Region & Coordinates ($I_f = 350 \text{ mA}$, $T_j = 85 \text{ }^\circ\text{C}$)

Region	CIE x	CIE y	Region	CIE x	CIE y
Y rank (2200 K)					
Y1	0.4805	0.3968	Y9	0.4925	0.4156
	0.4854	0.3968		0.4976	0.4156
	0.4915	0.4062		0.5038	0.4250
	0.4865	0.4062		0.4984	0.4250
Y2	0.4854	0.3968	YA	0.4976	0.4156
	0.4903	0.3969		0.5028	0.4156
	0.4966	0.4062		0.5091	0.4249
	0.4915	0.4062		0.5038	0.4250
Y3	0.4903	0.3969	YB	0.5028	0.4156
	0.4952	0.3969		0.5080	0.4156
	0.5016	0.4062		0.5145	0.4249
	0.4966	0.4062		0.5091	0.4249
Y4	0.4952	0.3969	YC	0.5080	0.4156
	0.5000	0.3969		0.5132	0.4156
	0.5066	0.4062		0.5198	0.4249
	0.5016	0.4062		0.5145	0.4249
Y5	0.4865	0.4062	YD	0.4984	0.4250
	0.4915	0.4062		0.5038	0.4250
	0.4976	0.4156		0.5099	0.4344
	0.4925	0.4156		0.5044	0.4344
Y6	0.4915	0.4062	YE	0.5038	0.4250
	0.4966	0.4062		0.5091	0.4249
	0.5028	0.4156		0.5154	0.4343
	0.4976	0.4156		0.5099	0.4344
Y7	0.4966	0.4062	YF	0.5091	0.4249
	0.5016	0.4062		0.5145	0.4249
	0.508	0.4156		0.5209	0.4342
	0.5028	0.4156		0.5154	0.4343
Y8	0.5016	0.4062	YG	0.5145	0.4249
	0.5066	0.4062		0.5198	0.4249
	0.5132	0.4156		0.5264	0.4342
	0.5080	0.4156		0.5209	0.4342

Region	CIE x	CIE y	Region	CIE x	CIE y
W rank (2700 K)					
W1	0.4373	0.3893	W9	0.4465	0.4071
	0.4418	0.3981		0.4513	0.4164
	0.4475	0.3994		0.4573	0.4178
	0.4428	0.3906		0.4523	0.4085
W2	0.4428	0.3906	WA	0.4523	0.4085
	0.4475	0.3994		0.4573	0.4178
	0.4532	0.4008		0.4634	0.4193
	0.4483	0.3919		0.4582	0.4099
W3	0.4483	0.3919	WB	0.4582	0.4099
	0.4532	0.4008		0.4634	0.4193
	0.4589	0.4021		0.4695	0.4207
	0.4538	0.3931		0.4641	0.4112
W4	0.4538	0.3931	WC	0.4641	0.4112
	0.4589	0.4021		0.4695	0.4207
	0.4646	0.4034		0.4756	0.4221
	0.4593	0.3944		0.4700	0.4126
W5	0.4418	0.3981	WD	0.4513	0.4164
	0.4465	0.4071		0.4562	0.4260
	0.4523	0.4085		0.4624	0.4274
	0.4475	0.3994		0.4573	0.4178
W6	0.4475	0.3994	WE	0.4573	0.4178
	0.4523	0.4085		0.4624	0.4274
	0.4582	0.4099		0.4687	0.4289
	0.4532	0.4008		0.4634	0.4193
W7	0.4532	0.4008	WF	0.4634	0.4193
	0.4582	0.4099		0.4687	0.4289
	0.4641	0.4112		0.4750	0.4304
	0.4589	0.4021		0.4695	0.4207
W8	0.4589	0.4021	WG	0.4695	0.4207
	0.4641	0.4112		0.4750	0.4304
	0.4700	0.4126		0.4813	0.4319
	0.4646	0.4034		0.4756	0.4221

d) Chromaticity Region & Coordinates

Region	CIE x	CIE y	Region	CIE x	CIE y
V rank (3000 K)					
V1	0.4147	0.3814	V9	0.4221	0.3984
	0.4183	0.3898		0.4259	0.4073
	0.4242	0.3919		0.4322	0.4096
	0.4203	0.3833		0.4281	0.4006
V2	0.4203	0.3833	VA	0.4281	0.4006
	0.4242	0.3919		0.4322	0.4096
	0.4300	0.3939		0.4385	0.4119
	0.4259	0.3853		0.4342	0.4028
V3	0.4259	0.3853	VB	0.4342	0.4028
	0.4300	0.3939		0.4385	0.4119
	0.4359	0.3960		0.4449	0.4141
	0.4316	0.3873		0.4403	0.4049
V4	0.4316	0.3873	VC	0.4403	0.4049
	0.4359	0.3960		0.4449	0.4141
	0.4418	0.3981		0.4513	0.4164
	0.4373	0.3893		0.4465	0.4071
V5	0.4183	0.3898	VD	0.4259	0.4073
	0.4221	0.3984		0.4299	0.4165
	0.4281	0.4006		0.4364	0.4188
	0.4242	0.3919		0.4322	0.4096
V6	0.4242	0.3919	VE	0.4322	0.4096
	0.4281	0.4006		0.4364	0.4188
	0.4342	0.4028		0.4430	0.4212
	0.4300	0.3939		0.4385	0.4119
V7	0.4300	0.3939	VF	0.4385	0.4119
	0.4342	0.4028		0.4430	0.4212
	0.4403	0.4049		0.4496	0.4236
	0.4359	0.3960		0.4449	0.4141
V8	0.4359	0.3960	VG	0.4449	0.4141
	0.4403	0.4049		0.4496	0.4236
	0.4465	0.4071		0.4562	0.4260
	0.4418	0.3981		0.4513	0.4164

Region	CIE x	CIE y	Region	CIE x	CIE y
U rank (3500 K)					
U1	0.3889	0.3690	U9	0.3941	0.3848
	0.3915	0.3768		0.3968	0.3930
	0.3981	0.3800		0.4040	0.3966
	0.3953	0.3720		0.4010	0.3882
U2	0.3953	0.3720	UA	0.4010	0.3882
	0.3981	0.3800		0.4040	0.3966
	0.4048	0.3832		0.4113	0.4001
	0.4017	0.3751		0.4080	0.3916
U3	0.4017	0.3751	UB	0.4080	0.3916
	0.4048	0.3832		0.4113	0.4001
	0.4116	0.3865		0.4186	0.4037
	0.4082	0.3782		0.4150	0.3950
U4	0.4082	0.3782	UC	0.4150	0.3950
	0.4116	0.3865		0.4186	0.4037
	0.4183	0.3898		0.4259	0.4073
	0.4147	0.3814		0.4221	0.3984
U5	0.3915	0.3768	UD	0.3968	0.3930
	0.3941	0.3848		0.3996	0.4015
	0.4010	0.3882		0.4071	0.4052
	0.3981	0.3800		0.4040	0.3966
U6	0.3981	0.3800	UE	0.4040	0.3966
	0.4010	0.3882		0.4071	0.4052
	0.4080	0.3916		0.4146	0.4089
	0.4048	0.3832		0.4113	0.4001
U7	0.4048	0.3832	UF	0.4113	0.4001
	0.4080	0.3916		0.4146	0.4089
	0.4150	0.3950		0.4222	0.4127
	0.4116	0.3865		0.4186	0.4037
U8	0.4116	0.3865	UG	0.4186	0.4037
	0.4150	0.3950		0.4222	0.4127
	0.4221	0.3984		0.4299	0.4165
	0.4183	0.3898		0.4259	0.4073

d) Chromaticity Region & Coordinates

Region	CIE x	CIE y	Region	CIE x	CIE y
T rank (4000 K)					
T1	0.3670	0.3578	T9	0.3702	0.3722
	0.3726	0.3612		0.3763	0.3760
	0.3744	0.3685		0.3782	0.3837
	0.3686	0.3649		0.3719	0.3797
T2	0.3726	0.3612	TA	0.3763	0.3760
	0.3783	0.3646		0.3825	0.3798
	0.3804	0.3721		0.3847	0.3877
	0.3744	0.3685		0.3782	0.3837
T3	0.3783	0.3646	TB	0.3825	0.3798
	0.3840	0.3681		0.3887	0.3836
	0.3863	0.3758		0.3912	0.3917
	0.3804	0.3721		0.3847	0.3877
T4	0.3840	0.3681	TC	0.3887	0.3837
	0.3898	0.3716		0.3950	0.3875
	0.3924	0.3794		0.3978	0.3958
	0.3863	0.3758		0.3912	0.3917
T5	0.3686	0.3649	TD	0.3719	0.3797
	0.3744	0.3685		0.3782	0.3837
	0.3763	0.3760		0.3802	0.3916
	0.3702	0.3722		0.3736	0.3874
T6	0.3744	0.3685	TE	0.3782	0.3837
	0.3804	0.3721		0.3847	0.3877
	0.3825	0.3798		0.3869	0.3958
	0.3763	0.3760		0.3802	0.3916
T7	0.3804	0.3721	TF	0.3847	0.3877
	0.3863	0.3758		0.3912	0.3917
	0.3887	0.3836		0.3937	0.4001
	0.3825	0.3798		0.3869	0.3958
T8	0.3863	0.3758	TG	0.3912	0.3917
	0.3924	0.3794		0.3978	0.3958
	0.3950	0.3875		0.4006	0.4044
	0.3887	0.3836		0.3937	0.4001

d) Chromaticity Region & Coordinates

Region	CIE x	CIE y	Region	CIE x	CIE y	Region	CIE x	CIE y	Region	CIE x	CIE y	Region	CIE x	CIE y		
R rank (5000 K)			QR rank (5300 K)			Q rank (5700 K)			PQ rank (6000 K)			P rank (6500 K)				
R1	0.3371	0.3490	Q2	0.3290	0.3417	Q1	0.3215	0.3350	P2	0.3144	0.3186	P1	0.3068	0.3113		
	0.3451	0.3554		0.3371	0.3490		0.3290	0.3417		0.3221	0.3261		0.3144	0.3186	0.3130	0.329
	0.344	0.3427		0.3366	0.3369		0.3290	0.330		0.3213	0.3373		0.3130	0.3290	0.3048	0.3207
	0.3366	0.3369		0.3290	0.3300		0.3222	0.3243		0.3130	0.3290		0.3215	0.335	0.3144	0.3186
R2	0.3451	0.3554	R1	0.3371	0.3490	Q2	0.3290	0.3417	Q1	0.3290	0.3417	P2	0.3221	0.3261		
	0.3533	0.3620		0.3451	0.3554		0.3371	0.3490		0.3290	0.3300		0.3290	0.3300	0.3213	0.3373
	0.3515	0.3487		0.3440	0.3427		0.3366	0.3369		0.3290	0.3300		0.3222	0.3243	0.3130	0.3290
	0.3440	0.3427		0.3366	0.3369		0.3290	0.3300		0.3215	0.335		0.3144	0.3186	0.3221	0.3261
R3	0.3376	0.3616	Q4	0.3290	0.3538	Q3	0.3207	0.3462	P4	0.3130	0.3290	P3	0.3048	0.3207		
	0.3463	0.3687		0.3376	0.3616		0.3290	0.3538		0.3213	0.3373		0.3130	0.3290	0.3115	0.3391
	0.3451	0.3554		0.3371	0.3490		0.3290	0.3417		0.3205	0.3481		0.3115	0.3391	0.3028	0.3304
	0.3371	0.349		0.3290	0.3417		0.3215	0.3350		0.3115	0.3391		0.3207	0.3462	0.3130	0.3290
R4	0.3463	0.3687	R3	0.3376	0.3616	Q4	0.3290	0.3538	Q3	0.3207	0.3462	P4	0.3048	0.3207		
	0.3551	0.3760		0.3463	0.3687		0.3376	0.3616		0.3290	0.3538		0.3290	0.3417	0.3115	0.3391
	0.3533	0.3620		0.3451	0.3554		0.3371	0.3490		0.3290	0.3417		0.3205	0.3481	0.3130	0.3290
	0.3451	0.3554		0.3371	0.3490		0.3290	0.3417		0.3215	0.3350		0.3115	0.3391	0.3213	0.3373

e) MacAdam Ellipse ($I_f = 350 \text{ mA}$, $T_j = 85 \text{ }^\circ\text{C}$)

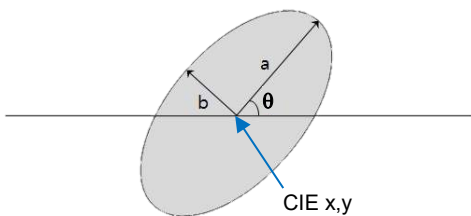

Nom. CCT (K)	Color Rank	Ellipse	Center		Rotation Angle θ ($^\circ$)	a	b
			CIE x	CIE y			
2200	YM	3-step	0.5018	0.4153	53.45	0.0072	0.0040
2700	WM	3-step	0.4578	0.4101	53.70	0.0081	0.0042
3000	VM	3-step	0.4338	0.4030	53.22	0.0083	0.0041
3500	UM	3-step	0.4073	0.3917	54.00	0.0093	0.0041
4000	TM	3-step	0.3818	0.3797	53.72	0.0094	0.0040
5000	RN	5-step	0.3447	0.3553	59.62	0.0137	0.0059
5700	QN	5-step	0.3287	0.3417	59.10	0.0125	0.0053
6500	PN	5-step	0.3123	0.3282	58.57	0.0116	0.0048

Note:

Samsung maintains measurement tolerance of: $C_x, C_y = \pm 0.005$

3. Typical Characteristics Graphs

a) Spectrum Distribution ($I_f = 350 \text{ mA}$, $T_j = 85 \text{ }^\circ\text{C}$)

Cool White (CRI70)

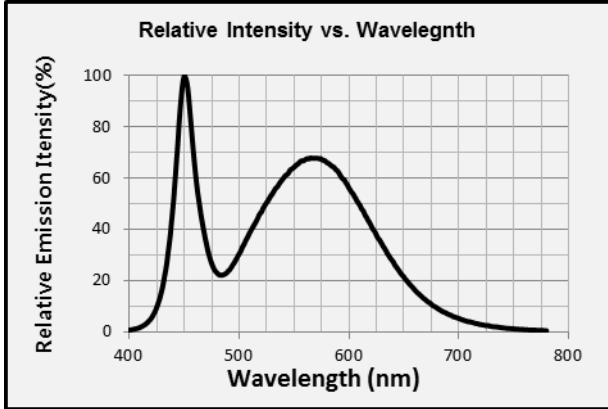

Warm White (CRI80)

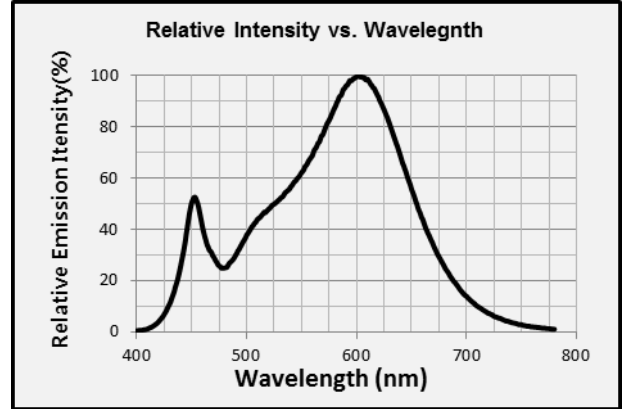

Warm White (CRI90)

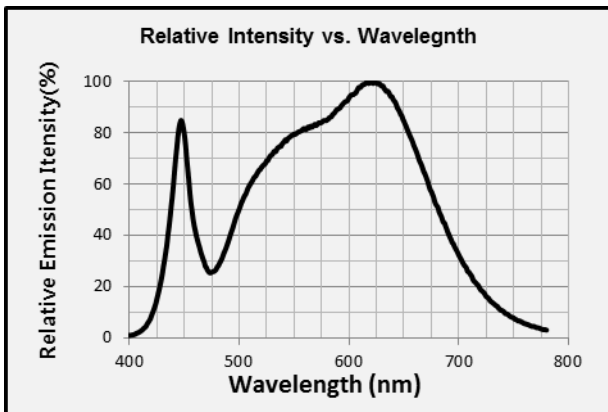

b) Forward Current Characteristics ($T_j = 85 \text{ }^\circ\text{C}$)

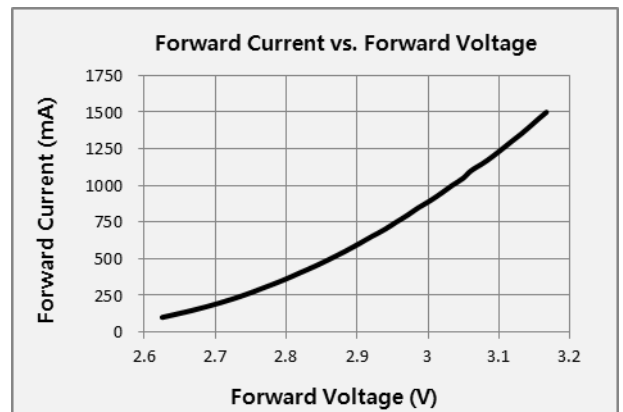
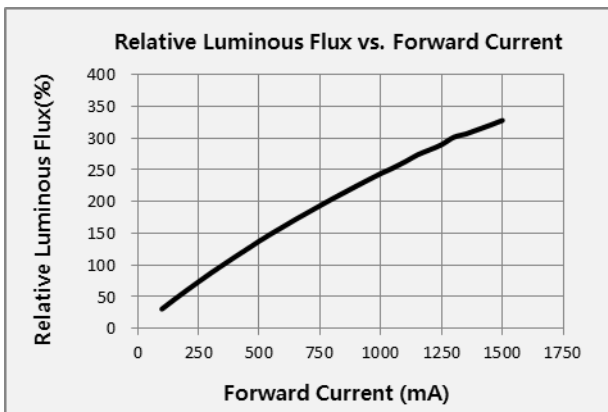

c) Temperature Characteristics ($I_f = 350 \text{ mA}$)

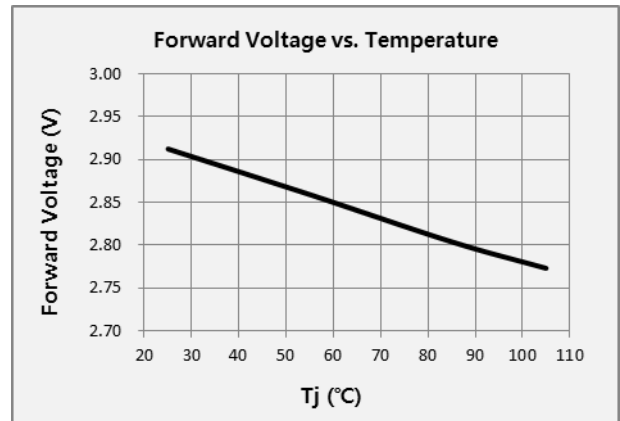
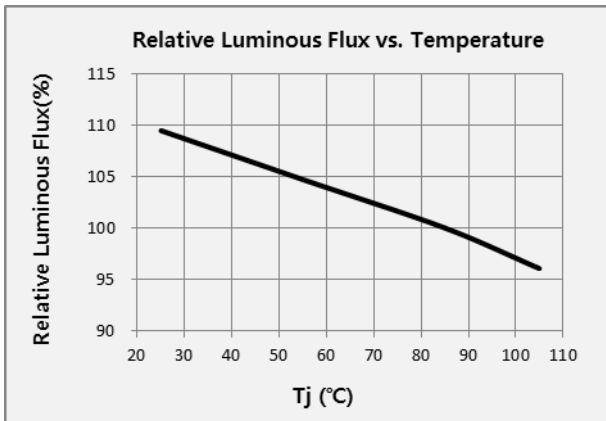

d) Color Shift Characteristics ($I_f = 350 \text{ mA}$, $T_j = 85 \text{ °C}$)

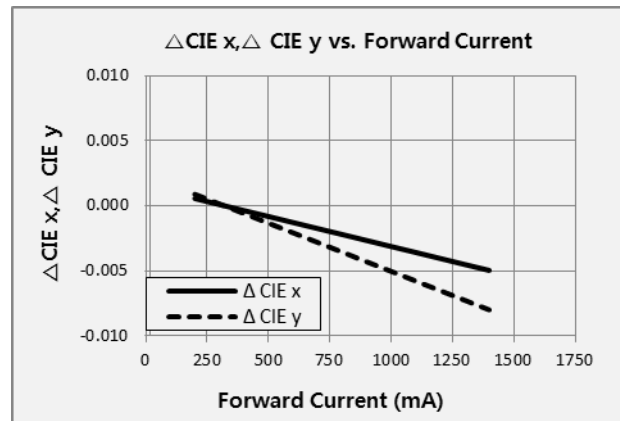
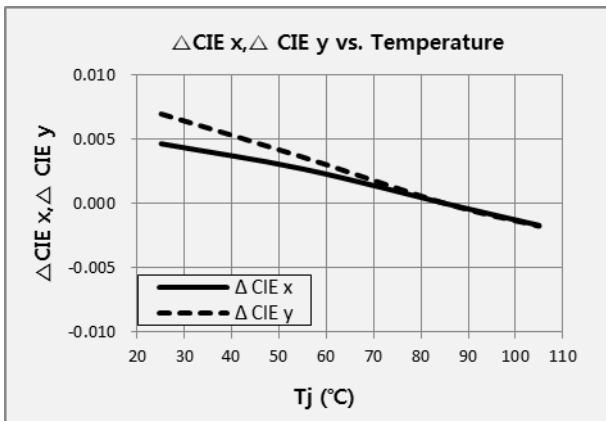

e) Derating Curve and Beam Angle Characteristics ($I_f = 350 \text{ mA}$, $T_j = 25 \text{ °C}$)

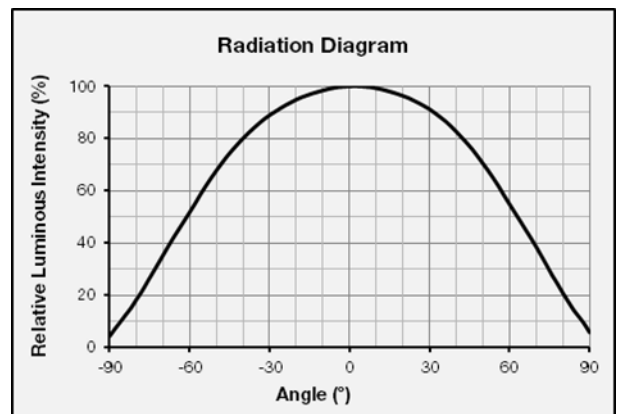
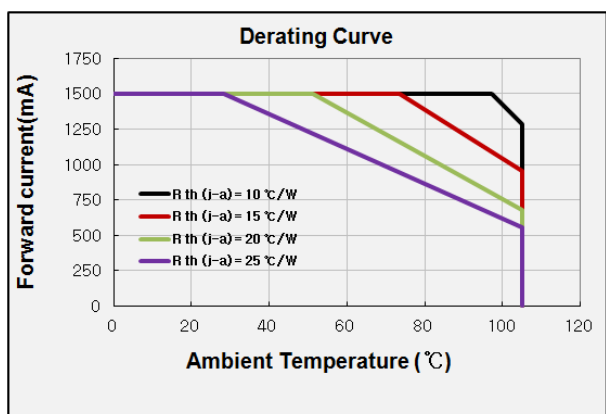

4. Outline Drawing & Dimension

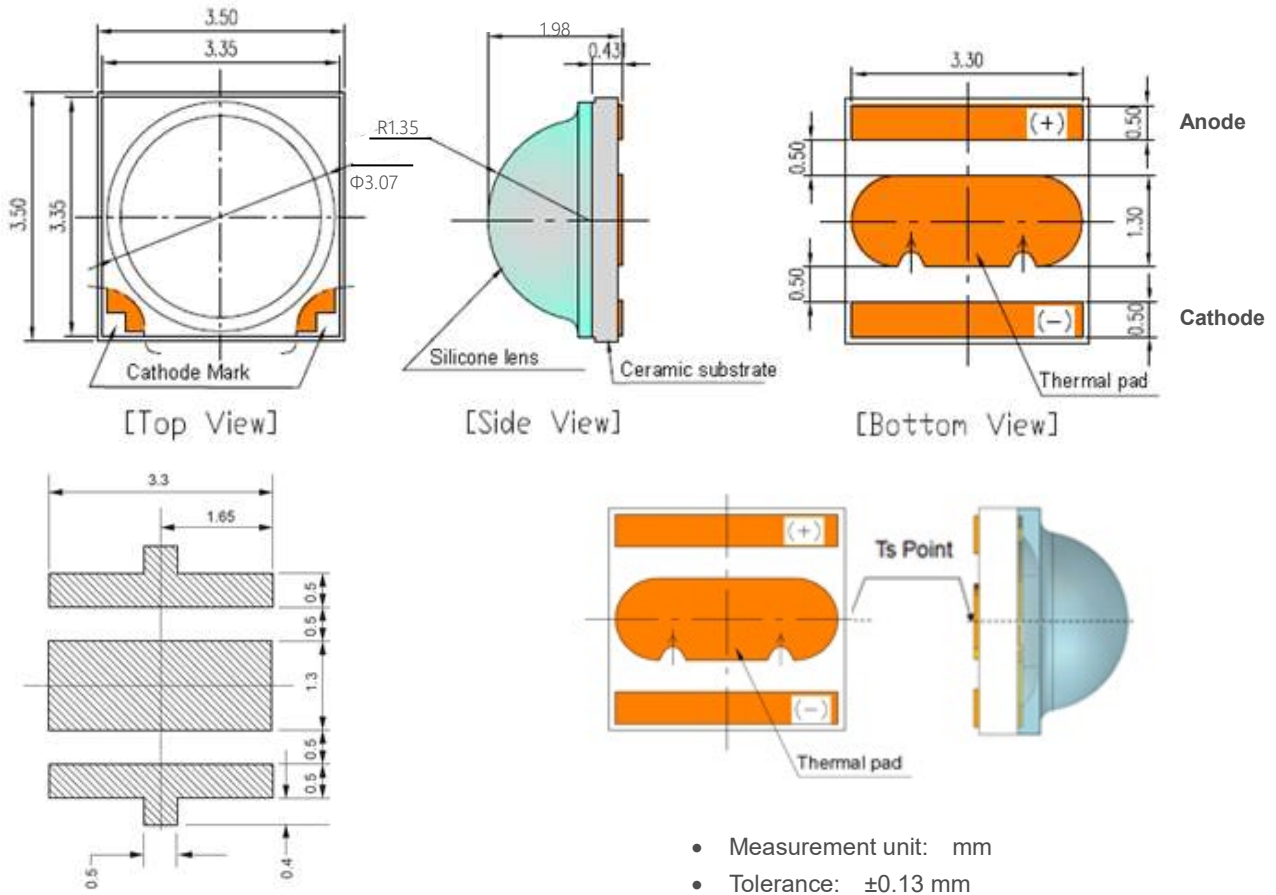

Recommended Soldering Pattern

Notes:

- 1) This LED has built-in ESD protection device(s) connected in parallel to LED chip(s).
- 2) The thermal pad is electrically isolated from the anode and cathode contact pads.
- 3) T_s point and measurement method:
 - ① Measure the nearest point to thermal pad as shown above. If necessary, remove PSR of PCB to reach T_s point.
 - ② All pads must be soldered to the PCB to dissipate heat properly, otherwise the LED can be damaged.

Precautions:

- 1) Pressure on the LEDs will influence to the reliability of the LEDs. Precautions should be taken to avoid strong pressure on the LEDs. Do not put stress on the LEDs during heating.
- 2) Re-soldering should not be done after the LEDs have been soldered. If re-soldering is unavoidable, LED's characteristics should be carefully checked before and after such repair.
- 3) Do not stack assembled PCBs together. Since materials of LEDs is soft, abrasion between two PCB assembled with LED might cause catastrophic failure of the LEDs.

5. Reliability Test Items & Conditions

a) Test Items

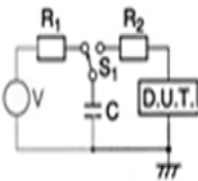
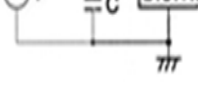
Test Item	Test Condition	Test Hour / Cycle
Room Temperature Life Test	25 °C, , Maximum Rated Drive Current	1000 h
High Temperature Life Test	85 °C, , Maximum Rated Drive Current	1000 h
High Temperature Humidity Life Test	85 °C, 85 % RH, , Maximum Rated Drive Current	1000 h
Low Temperature Life Test	-40 °C, , Maximum Rated Drive Current	1000 h
Damp Heat Cycling	-10 °C ↔ 25 °C 95 % RH ↔ 65 °C 95 % RH , Maximum Rated Drive Current, 24 h / 1 cycle	10 cycles
Powered Temperature Cycle	-40 °C / 85 °C each 20 min, 100 min transfer power on/off each 5 min, , Maximum Rated Drive Current	100 cycles
Temperature Cycling	-45 °C / 15 min ↔ 125 °C / 15 min temperature change within 5 min	500 cycles
High Temperature Storage	120 °C	1000 h
Low Temperature Storage	-40 °C	1000 h
ESD (HBM)	 <p> R_1: 10 MΩ R_2: 1.5 kΩ C: 100 pF V: ± 8 kV </p>	5 times
ESD (MM)	 <p> R_1: 10 MΩ R_2: 0 C: 200 pF V: ± 0.5 kV </p>	5 times
Vibration Test	20~2000~20 Hz, 200 m/s ² , sweep 4 min X, Y, Z 3 direction, each 1 cycle	4 cycles
Mechanical Shock Test	1500 g, 0.5 ms 3 shocks each X-Y-Z axis	5 cycles

b) Criteria for Judging the Damage

Item	Symbol	Test Condition ($T_j = 25$ °C)	Limit	
			Min.	Max.
Forward Voltage	V_f	$I_f = 350$ mA	Init. Value * 0.9	Init. Value * 1.1
Luminous Flux	Φ_v	$I_f = 350$ mA	Init. Value * 0.7	Init. Value * 1.1

6. Soldering Conditions

a) Reflow Conditions (Pb free)

Reflow frequency: 2 times max.

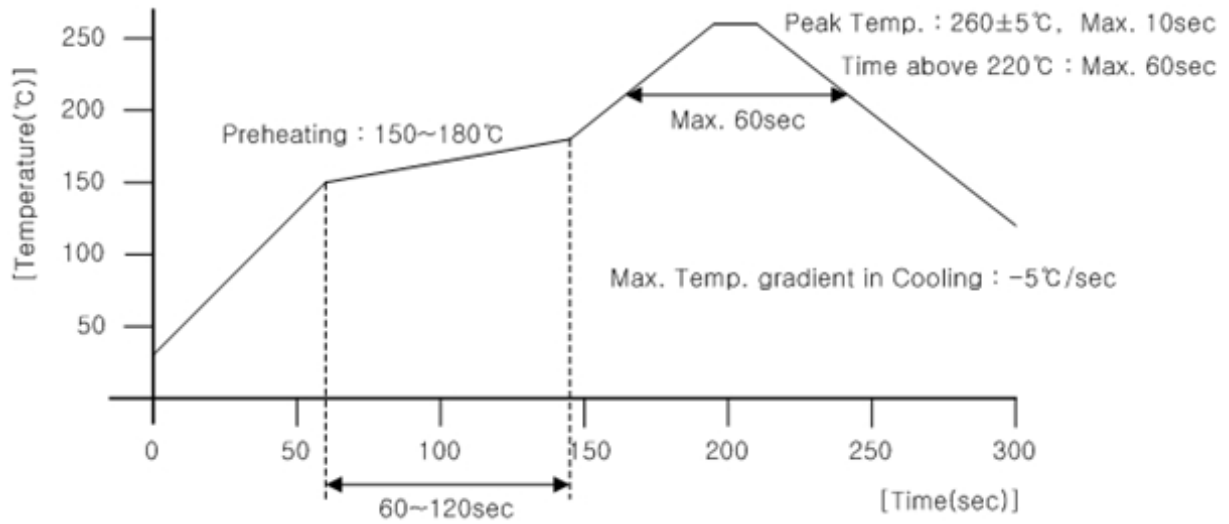

b) Manual Soldering Conditions

Not more than 5 seconds @ max. 300 °C, under soldering iron.

7. Tape & Reel

a) Taping Dimension

(unit: mm)

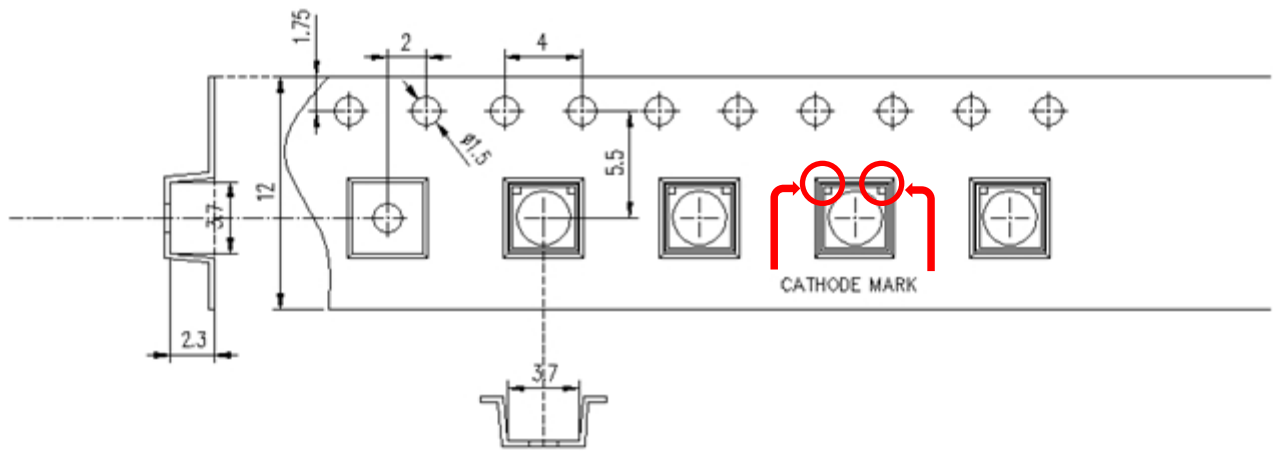

Taping Direction



End

Start

More than 40 mm
Unloaded tape

Mounted with
LED package

More than 100~200 mm
Unloaded tape

Leading part more than
200~400 mm

b) Reel Dimension

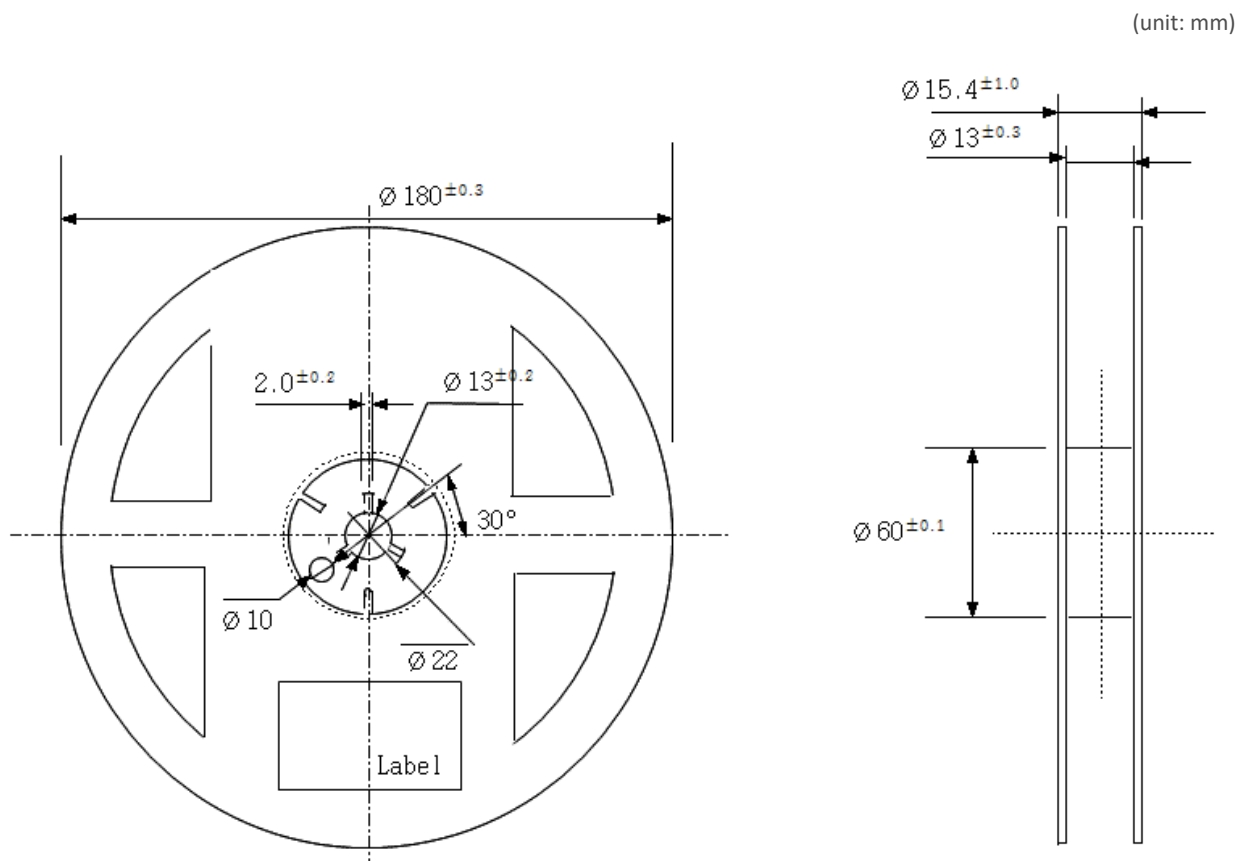

Notes:

- 1) Quantity: The quantity/reel is 1,000 pcs
- 2) Cumulative tolerance: Cumulative tolerance / 10 pitches is ± 0.2 mm
- 3) Adhesion strength of cover tape: Adhesion strength is 0.1-0.7 N when the cover tape is turned off from the carrier tape at 10° angle to the carrier tape
- 4) Packaging: P/N, Manufacturing data code no. and quantity are indicated on the aluminum packing bag

8. Label Structure

a) Label Structure

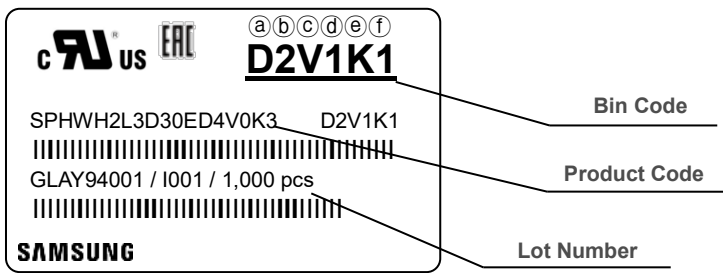

Note: Denoted bin code and product code above is only an example (see description on page 7)

Bin Code:

- ⒶⒷ: Forward Voltage bin (refer to page 15)
- ⒸⒹ: Chromaticity bin (refer to page 16-19)
- ⒺⒻ: Luminous Flux bin (refer to page 8-11)

b) Lot Number

The lot number is composed of the following characters:

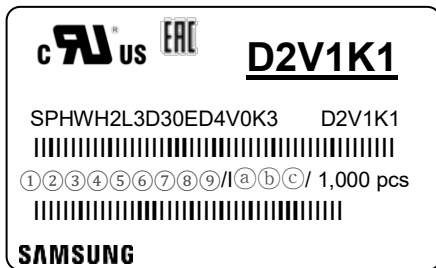

①②③④⑤⑥⑦⑧⑨ / IⒶⒷⒸ / 1,000 pcs

- ①, ② : Production site (GL: Tianjin, China, GB : Nanchang, China)
- ③ : Product state (A: Normal, B: Bulk, C: First Production, R: Reproduction, S: Sample)
- ④ : Year (Y: 2014, Z: 2015, A: 2016, B: 2017, C: 2018, D: 2019 ...)
- ⑤ : Month (1~9, A, B, C)
- ⑥ : Day (1~9, A, B~V)
- ⑦⑧⑨ : Product serial number (001 ~ 999)
- ⒶⒷⒸ : Reel number (001 ~ 999)

9. Packing Structure

a) Packing Process

Reel

D2V1K1
 SPHWH2L3D30ED4V0K3 D2V1K1
 GLAY94001 / I001 / 1,000 pcs
SAMSUNG

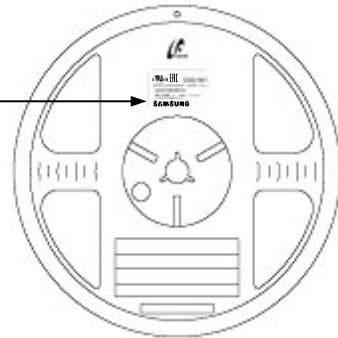
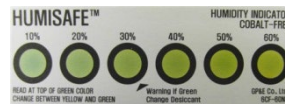

Aluminum Vinyl Packing Bag



D2V1K1
 SPHWH2L3D30ED4V0K3 D2V1K1
 GLAY94001 / I001 / 1,000 pcs
SAMSUNG



Outer Box

Material: Paper SW(B)

Type	Size (mm)			Note
	(a)	(b)	(c)	
7 inch (L)	245 ± 5	220 ± 5	182 ± 5	Up to 8 reels
7 inch (S)	245 ± 5	220 ± 5	86 ± 5	Up to 4 reels

D2V1K1
 SPHWH2L3D30ED4V0K3 D2V1K1
 GLAY94001 / I001 / 8,000 pcs
SAMSUNG

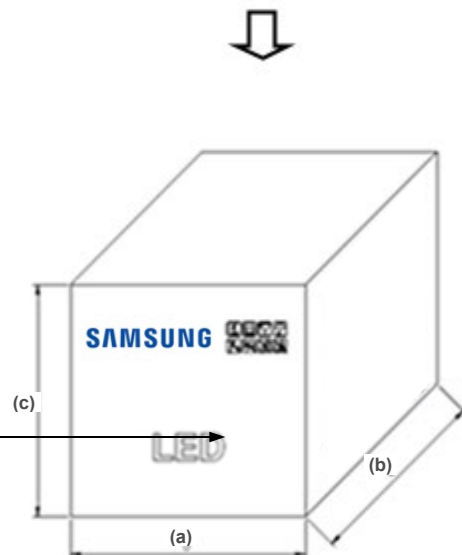

b) Aluminum Vinyl Packing Bag



CAUTION

This bag contains
MOISTURE SENSITIVE DEVICES

LEVEL
2a



D2V1K1

SPHWH2L3D30ED4V0K3 D2V1K1

GLAY94001 / I001 / 1,000 pcs

SAMSUNG

1. Shelf life in sealed bag: 12 months at <math>< 40^{\circ}\text{C}</math> and <math>< 90\%</math> relative humidity (RH)

2. Peak package body temperature: 240 °C

3. After this bag is opened, devices that will be subjected to reflow solder or other high temperature processes must be:

- a. Mounted within 672 hours at factory conditions of equal to or less than 30°C / 60% RH, or
- b. Stored at <math>< 10\%</math> RH

4. Devices require bake, before mounting, if:

- a. Humidity Indicator Card is > 65% when read at 23±5°C, or
- b. 2a is not met.

5. If baking is required, devices must be baked for 1 hours at 60±5°C

Note: If device containers cannot be subjected to high temperature or shorter bake times are desired, reference IPC/JEDEC J-STD-033 for bake procedure.

Bag seal due date: _____

(If blank, see code label)

Note: Level and body temperature by IPC/JEDEC J-STD-020





주의 사항

이 알루미늄 지퍼 팩은 습기 및 정전기로부터 제품을 보호하기 위하여 제작되었습니다. 개봉 후에는 즉시 솔더 작업을 실시하는 것을 권장합니다.

습기 및 정전기로부터 제품을 보호 하기 위해서 개봉 후 사용하지 않는 자재는 본 팩에 넣어 보관 하시기 바랍니다. 사용하지 않는 자재를 본 팩에 넣을 때는 반드시 동봉된 드라이 팩과 함께 넣고 지퍼부분을 완전하게 밀봉하여 주시기 바랍니다.

Important

This Al Zipper bag is designed to protect the enclosed products from moisture and ESD. Once opened, the products should be soldered onto the printed circuit board immediately. When not in use, please do not leave the products unprotected by the Al Zipper Bag. To repack unused products., please ensure the zip-lock is completely sealed with the dry pack left inside.

c) Silica Gel & Humidity Indicator Card inside Aluminum Vinyl Bag



DESICCANT
SILICA
DO NOT
REUSE
CANT
GEL
SIL

HUMISAFE™

10% 20% 30% 40% 50% 60%

READ AT TOP OF GREEN COLOR
CHANGE BETWEEN YELLOW AND GREEN

**HUMIDITY INDICATOR
COBALT-FREE**

Warning If Green
Change Desiccant

GP&E Co., Ltd.
6CF-60NS

10. Precautions in Handling & Use

- 1) For over-current protection, users are recommended to apply resistors connected in series with the LEDs to mitigate sudden change of the forward current caused by shift of forward voltage.
- 2) This device should not be used in any type of fluid such as water, oil, organic solvent, etc. When cleaning is required, IPA is recommended as the cleaning agent. Some solvent-based cleaning agent may damage the silicone resins used in the device.
- 3) When the device is in operation, the forward current should be carefully determined considering the maximum ambient temperature and corresponding junction temperature.
- 4) LEDs must be stored in a clean environment. Shelf life of sealed bags is 12 months at temperature 0~40 °C, 0~90 % RH.
- 5) After storage bag is opened, device subjected to soldering, solder reflow, or other high temperature processes must be:
 - a. Mounted within 672 hours (28 days) at an assembly line with a condition of no more than 30 °C / 60 % RH, or
 - b. Stored at <10 % RH
- 6) Repack unused devices with anti-moisture packing, fold to close any opening and then store in a dry place.
- 7) Devices require baking before mounting, if humidity card reading is >60 % at 23 ± 5 °C.
- 8) Devices must be baked for 1 hour at 60 ± 5 °C, if baking is required.
- 9) The LEDs are sensitive to the static electricity and surge current. It is recommended to use a wrist band or anti-electrostatic glove when handling the LEDs. If voltage exceeding the absolute maximum rating is applied to LEDs, it may cause damage or even destruction to LED devices. Damaged LEDs may show some unusual characteristics such as increase in leakage current, lowered turn-on voltage, or abnormal lighting of LEDs at low current.
- 10) VOCs (Volatile Organic Compounds) can be generated from adhesives, flux, hardener or organic additives used in luminaires (fixtures). Transparent LED silicone encapsulant is permeable to those chemicals and they may lead to a discoloration of encapsulant when they exposed to heat or light. This phenomenon can cause a significant loss of light emitted (output) from the luminaires. In order to prevent these problems, we recommend users to know the physical properties of materials used in luminaires and they must be carefully selected.

Legal and additional information.

[About Samsung Electronics Co., Ltd.](#)

Samsung Electronics Co., Ltd. inspires the world and shapes the future with transformative ideas and technologies, redefining the worlds of TVs, smartphones, wearable devices, tablets, cameras, digital appliances, printers, medical equipment, network systems and semiconductors.

We are also leading in the Internet of Things space through, among others, our Digital Health and Smart Home initiatives. We employ 307,000 people across 84 countries. To discover more, please visit our official website at www.samsung.com and our official blog at global.samsungtomorrow.com.

“Samsung provides limited warranty for its LED products, the full text of which is available at <https://www.samsung.com/led/support/warranties>“

Copyright © 2016 Samsung Electronics Co., Ltd. All rights reserved.

Samsung is a registered trademark of Samsung Electronics Co., Ltd.

Specifications and designs are subject to change without notice. Non-metric weights and measurements are approximate. All data were deemed correct at time of creation. Samsung is not liable for errors or omissions. All brand, product, service names and logos are trademarks and/or registered trademarks of their respective owners and are hereby recognized and acknowledged.

Samsung Electronics Co., Ltd.

1, Samsung ro

Giheung-gu

Yongin-si, Gyeonggi-do, 17113

KOREA

www.samsungled.com