

FEATURES

- Easy access to the AD7879/AD7879-1
- Connects to any PC USB port
- Self-contained evaluation system
- Test points for easy access to signals
- Touch screen included

PACKAGE CONTENTS

- AD7879/AD7879-1 evaluation board
- USB cable
- CD with evaluation software, schematics,
and EVAL-AD7879 data sheet
- 4-wire resistive screen

PRODUCT DESCRIPTION

The AD7879/AD7879-1 evaluation board allows you to evaluate all features of the AD7879/AD7879-1. The evaluation software allows you to change the settings on the AD7879/AD7879-1. You can connect the touch screen to Connector J3 or use the on-board variable resistors to evaluate the touch screen function.

EVALUATION BOARD BLOCK DIAGRAM

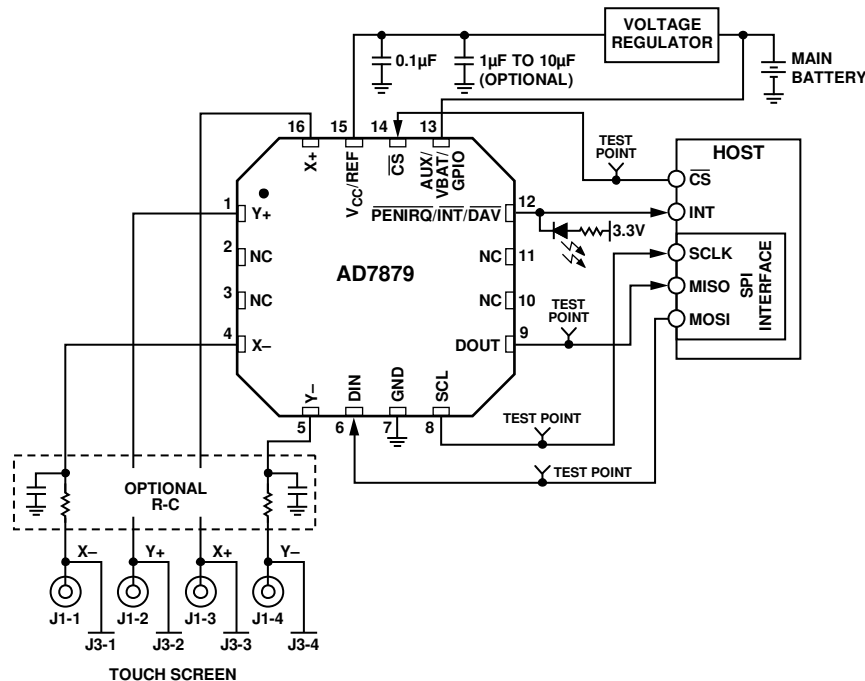

Figure 1.

Rev. 0

Evaluation boards are only intended for device evaluation and not for production purposes. Evaluation boards are supplied "as is" and without warranties of any kind, express, implied, or statutory including, but not limited to, any implied warranty of merchantability or fitness for a particular purpose. No license is granted by implication or otherwise under any patents or other intellectual property by application or use of evaluation boards. Information furnished by Analog Devices is believed to be accurate and reliable. However, no responsibility is assumed by Analog Devices for its use, nor for any infringements of patents or other rights of third parties that may result from its use. Analog Devices reserves the right to change devices or specifications at any time without notice. Trademarks and registered trademarks are the property of their respective owners. Evaluation boards are not authorized to be used in life support devices or systems.

TABLE OF CONTENTS

| | | | |
|--------------------------------------|---|--|----|
| Features | 1 | Installing the Software | 5 |
| Package Contents..... | 1 | Running the Software | 5 |
| Product Description..... | 1 | Evaluation Demo | 6 |
| Evaluation Board Block Diagram..... | 1 | Register Control Tab | 6 |
| Revision History | 2 | Result Plotting Tab | 8 |
| Evaluation Board | 3 | XY Coordinates Tab..... | 10 |
| Setting up the Evaluation Board..... | 3 | Temperature Monitor Tab | 11 |
| Evaluation Board Description | 3 | Battery Monitor Tab..... | 12 |
| Evaluation Board Hardware..... | 4 | AD7879 Registers Tab | 13 |
| Connectors | 4 | Evaluation Board Schematics and Artwork..... | 14 |
| Links..... | 4 | Ordering Information..... | 18 |
| Indicators..... | 4 | Ordering Guide | 18 |
| Evaluation Board Software..... | 5 | ESD Caution..... | 18 |

REVISION HISTORY

7/09—Revision 0: Initial Version

EVALUATION BOARD

SETTING UP THE EVALUATION BOARD

Follow these steps to set up the AD7879/AD7879-1 evaluation board:

1. Install the evaluation software CD before connecting the board.
2. Plug the USB connector from the USB port on your PC into the mini-USB socket on the evaluation board. The power indicator LED on the board should turn on.
3. Ensure that all switches and links are in their default positions; Link L5 should be in Position B.
4. Start the AD7879/AD7879-1 evaluation software.
5. When the evaluation software loads, click **Evaluation Demo** or **Exit**. To investigate how the AD7879/AD7879-1 works, click **Evaluation Demo**. To exit the software, click **Exit**.

EVALUATION BOARD DESCRIPTION

The AD7879/AD7879-1 evaluation board allows you to evaluate all features of the AD7879/AD7879-1. The board is powered via the USB connection to the host PC. The evaluation software allows data to be read from and written to the AD7879/AD7879-1. The evaluation software should be installed on the PC before the evaluation board is plugged in.

This evaluation board contains the following main components that can be identified from the block diagram in Figure 1. The printed circuit board (PCB) schematics and silkscreen are shown in Figure 13 through Figure 15.

- AD7879/AD7879-1 IC
- USB Microcontroller IC CY7C68013-56LFC
- LED indicators for power and $\overline{\text{PENIRQ}}$
- EEPROM for USB initialization information
- Connector for USB interface
- Connector for touch screen
- Screw-top connectors for the following signals: X-, Y+, X+, Y-, V_{CC}, and GND
- Test points for the following signals: DOUT, DIN, SCL, $\overline{\text{CS}}$, $\overline{\text{PENIRQ}}$, V_{CC}, GND, and VBAT

EVALUATION BOARD HARDWARE**CONNECTORS****Table 1. Connector Function Descriptions**

| Number | Name | Description |
|---------------|---------------|---|
| J6 | USB interface | The USB cable should be plugged directly from the PC into this connector. It is a type USB mini-B socket. |
| J2-1 | Power | Power can be supplied to the board either to the USB cable or via Power Connector J2. If Link 5 is in Position B, power is supplied via the USB cable. If Link 5 is in Position A, power is supplied from the J2-1 connector. |
| J2-2 | AGND | An external ground can be connected via the J2-2 connector. |
| J2-3 | EXT_BAT | This pin of the J2 connector can be used to apply a signal to the AUX/VBAT/GPIO input on the AD7879/AD7879-1. Link 7 must be in Position B for this connector to be linked to the AD7879/AD7879-1. |
| J3 | Touch screen | The Touch International touch screen included with the demonstration kit can be connected directly into the AD7879/AD7879-1 demonstration board using this connector. Connections are as follows: X– to J3-1, Y+ to J3-2, X+ to J3-3, and Y– to J3-4. |
| J1 | Touch screen | This connector can be used to connect a touch screen to the AD7879/AD7879-1 and should be connected as follows: X– to J1-1, Y+ to J1-2, X+ to J1-3, and Y– to J1-4. |

LINKS**Table 2. Link Function Descriptions**

| Number | Name | Default Position | Description |
|---------------|-------------|-------------------------|---|
| L1 | X+ | A | This jumper selects the X+ input on the AD7879/AD7879-1. If the jumper is in Position A, the X+ input comes from touch screen Connector J1-3 or Connector J3-3. |
| L2 | Y+ | A | This jumper selects the Y+ input on the AD7879/AD7879-1. If the jumper is in Position A, the Y+ input comes from touch screen Connector J1-2 or Connector J3-2. |
| L4 | X– | A | This jumper selects the X– input on the AD7879/AD7879-1. If the jumper is in Position A, the X– input comes from touch screen Connector J1-1 or Connector J3-1. |
| L6 | Y– | A | This jumper selects the Y– input on the AD7879/AD7879-1. If the jumper is in Position A, the Y– input comes from touch screen Connector J1-4 or Connector J3-4. |
| L5 | Input power | B | This jumper selects the input power for the evaluation board. If the jumper is in Position A, power for the evaluation board must be supplied through Connector J2-1. If the link is in Position B, the USB connection supplies the power for the evaluation board. |
| L7 | VBAT input | A | This jumper selects the input signal to the AUX/VBAT/GPIO input on the AD7879/AD7879-1. If the jumper is in Position B, VBAT is connected to Connector J2-3. An input voltage can then be connected to J2-3. If the link is in Position A, VBAT is connected to a variable resistor, R5. The user can vary R5 to change the input voltage on the VBAT pin. The maximum resistance of R5 is 10 kΩ. |

INDICATORS**Table 3. Indicator LED Descriptions**

| Number | Name | Description |
|---------------|--------------|--|
| D1 | PENIRQ green | When illuminated, this LED indicates that the PENIRQ interrupt is active on the AD7879/AD7879-1. |
| D4 | Power green | When illuminated, this LED indicates that the evaluation board is powered. |

EVALUATION BOARD SOFTWARE

The AD7879/AD7879-1 evaluation software configures the part into master mode so that no measurements are taken from the part unless the screen is touched.

You can change the register settings, plot and save data from the AD7879/AD7879-1, and plot the X and Y positions using the evaluation software.

INSTALLING THE SOFTWARE

The software should be installed before the evaluation board is plugged into the host computer.

To install the evaluation software, run the AD7879Evaluation SoftwareInstall.exe program, found at www.analog.com/AD7879, under the Evaluation Boards heading. Follow the on-screen installation. You must accept the licensing agreement to complete the installation. The software is installed and saved into the **AD7879 Evaluation Software** directory.

RUNNING THE SOFTWARE

Before running the software, ensure that the evaluation board is plugged into the USB port of the host computer. Run the software from the **AD7879 Evaluation Software** directory. After the software starts running, the **AD7879 Evaluation Software** dialog box shown in Figure 2 appears. You can choose two options: **Evaluation Demo** or **Exit**. **Exit** shuts down the evaluation software, and **Evaluation Demo** allows you to investigate how the AD7879/AD7879-1 works.

At the lower left of this dialog box are the software and firmware revision numbers. On the lower right of the dialog box, the AD7879/AD7879-1 device ID and silicon revision are displayed. The device ID should be 37A if the interface is SPI (AD7879) and 379 if the interface is I²C (AD7879-1). If this number is incorrect, the software has not initialized properly. In this situation, exit the software and then restart it. If an error persists, exit the software, disconnect the USB connector from the board, and reinstall the evaluation software.

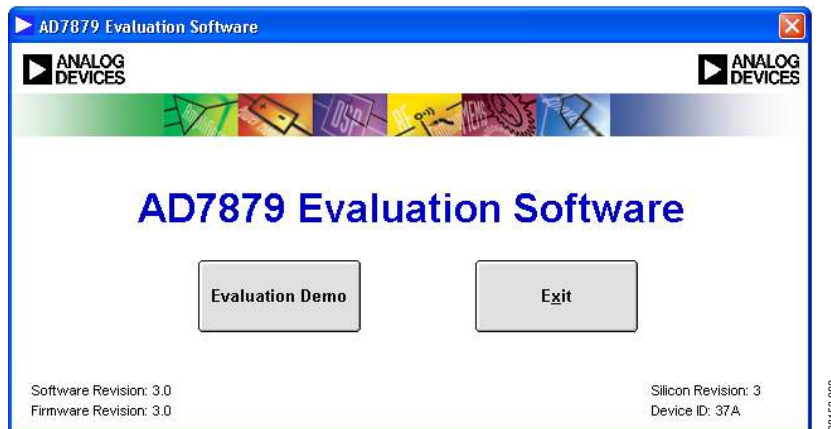

Figure 2. AD7879 Evaluation Software Window, Start-Up Dialog Box

EVALUATION DEMO

The evaluation demo allows you to set up the AD7879/AD7879-1 control registers according to the requirements of a specific application. The demo also displays the X and Y coordinates and allows you to investigate how the temperature sensor and the battery monitor work.

REGISTER CONTROL TAB

Clicking **Evaluation Demo** in the **AD7879 Evaluation Software** dialog box opens the window shown in Figure 3. The **Register Control** tab allows you to read and modify the values of Control Register 1, Control Register 2, and Control Register 3. By using the software, you can program the main features of the AD7879/

AD7879-1 and modify the content of the three control registers. The bits displayed are automatically updated when any of the programmable features is changed.

Control Register 1

Write to Control Register 1 either by typing values (from 550 μ s to 9.440 ms in steps of 35 μ s.) into the **Conversion Interval Timer** box or by selecting an option from the following drop-down boxes in the **Control Register 1 0x01** area: **ADC Acquisition Time**, **ADC Conversion Mode**, and **ADC Channel Address**. In addition, selecting the **PENIRQ** check box enables the pen interrupt.

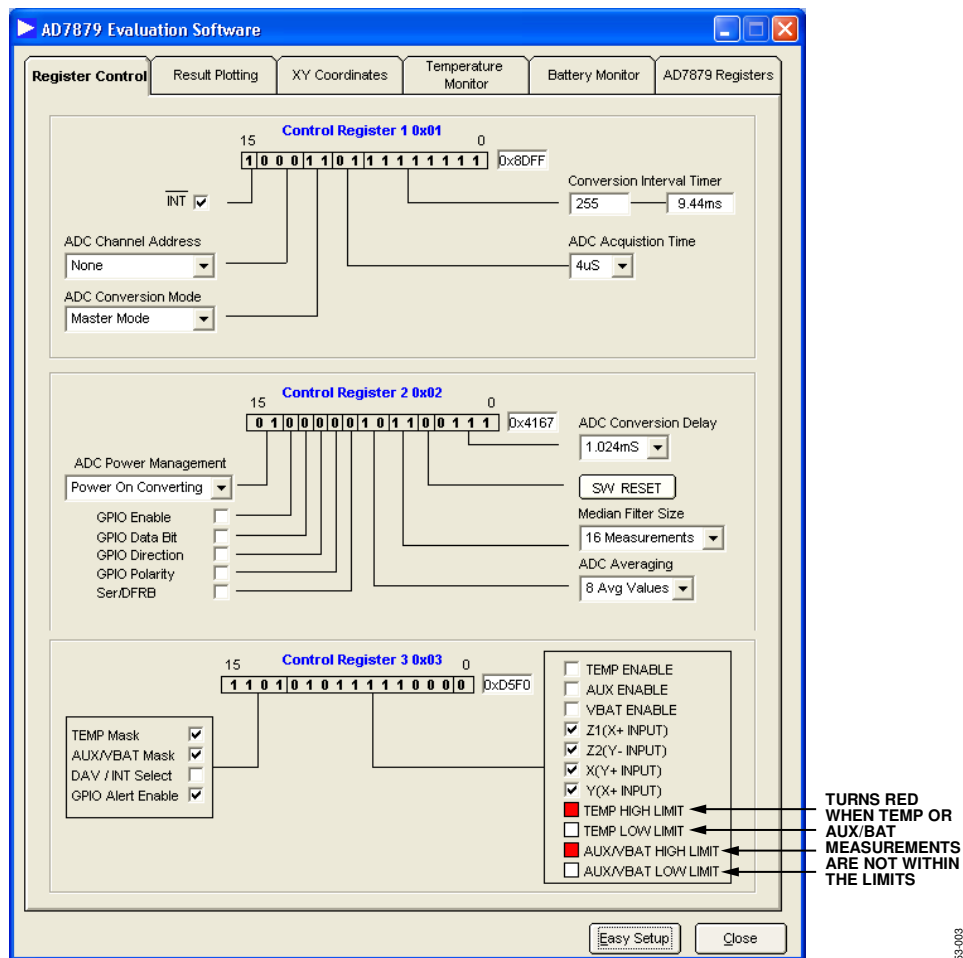

Figure 3. Register Control Tab

Control Register 2

The **Control Register 2 0x02** area provides access to the first conversion delay (selectable from 128 μ s to 4.096 ms) and to the settings of the median and averaging filters. The median filter size can be selected from 4 to 16 measurements, or this feature can be disabled. The averaging filter can accept 2, 4, 8, or 16 median values. Clicking **SW RESET** resets the values of all the registers. The check boxes in the **Control Register 2 0x02** area allow you to modify the GPIO features. It is also possible to select whether the single-ended or differential mode is used to perform the measurements. Selecting the last check box, the **Ser/DFRB** check box, disables the median and the averaging filters. The power management bits can be programmed in this box by using the **ADC Power Management** drop-down box.

Control Register 3

The **Control Register 3 0x03** area includes the bits to configure the interrupts on the AD7879/AD7879-1 and the bits to indicate the measurements contained in the sequencer.

On the right side of the **Control Register 3 0x03** area, there are 11 check boxes. By selecting the corresponding check box, the following channels can be included in the conversion sequencer: temperature, auxiliary, battery, Z1, Z2, X, and Y. The lower four check boxes are read only and indicate if the value of the channel measured is outside its limits, in which case the box is red. For example, Figure 3 shows that the temperature value is below its low limit and the battery measurement is above its high limit.

On the left side of the **Control Register 3 0x03** area, there are four check boxes. The interrupt sources can be masked by clearing the corresponding enable bit in Control Register 3; this can be done by selecting the **TEMP Mask** and **AUX/VBAT Mask** check boxes. The behavior of the interrupt output (data available or interrupt) can be set by selecting the **DAV/INT Select** check box. The GPIO can operate as an alarm by selecting the **GPIO Alert Enable** check box.

Easy Setup

Clicking **Easy Setup** at the bottom of **AD7879 Evaluation Software** window sets up and starts running the AD7879/AD7879-1.

The evaluation software writes to the AD7879/AD7879-1 to set up the registers. Then the software programs the device to perform a measurement of each channel before proceeding to the next measurement, and then this cycle is repeated. Z1, Z2, X, and Y are chosen by selecting the appropriate check box in the **Control Register 3 0x03** area and then clicking **Easy Setup**.

In the example shown in Figure 3, the AD7879/AD7879-1 is working in master mode. The ADC and the reference are in power-on converting mode. The timer is set to convert every 9.44 ms. The GPIO is disabled by default.

Therefore, clicking **Easy Setup** sets the conversion mode to differential. The median filter size is set to 16 measurements, and the averaging filter is set to eight values. Both filters are enabled by default. The first ADC conversion delay is set to 1.024 ms (in the **ADC Conversion Delay** drop-down box in the **Control Register 2 0x02** area) and the ADC acquisition time is set to 4 μ s (in the **ADC Acquisition Time** box in the **Control Register 1 0x01** area). Any of these settings can be changed by writing to the relevant control register.

The limits are written to the limit registers for all relevant channels. The AUX/VBAT limits are set to 0.64 V (lower limit) and 2.26 V (upper limit). The temperature limits are set to 17°C (lower limit) and 35°C (upper limit)

More information on programming the registers and on the register contents can be found in the AD7879/AD7879-1 data sheet.

EVAL-AD7879

RESULT PLOTTING TAB

Clicking the **Result Plotting** tab opens the window shown in Figure 4. Values measured by the AD7879/AD7879-1 can be graphed in this window.

The evaluation board offers three options to measure the X and Y coordinates: connect the screen provided in this kit to Connector J3, connect any other screen to Connector J1, or use Variable Resistors R2 and R6 to simulate the resistance of the screen.

Connecting a Touch Screen to the Board

The touch screen that is included with the EVAL-AD7879/AD7879-1 kit can be connected to the board using J3. First, ensure that the L1, L2, L4, and L6 links are in Position A.

The 4-wire resistive screen should be connected with the green side of the flex tail facing the board. Flip to tail round after the screen is secured in the connector so that the board lies flat, with the green side of the flex tail facing upwards. The included touch screen requires a strong activation force; therefore, ensure that you exert enough force when touching the screen.

Use Connector J1 to connect any other touch screen to the board.

Using the Variable Resistors

Variable Resistors R2 and R6 can be used to mimic a touch screen if a touch screen is not available. Ensure that the L1, L2, L4, and L6 links are in Position B. The variable resistors can then be adjusted to mimic a user touching a screen.

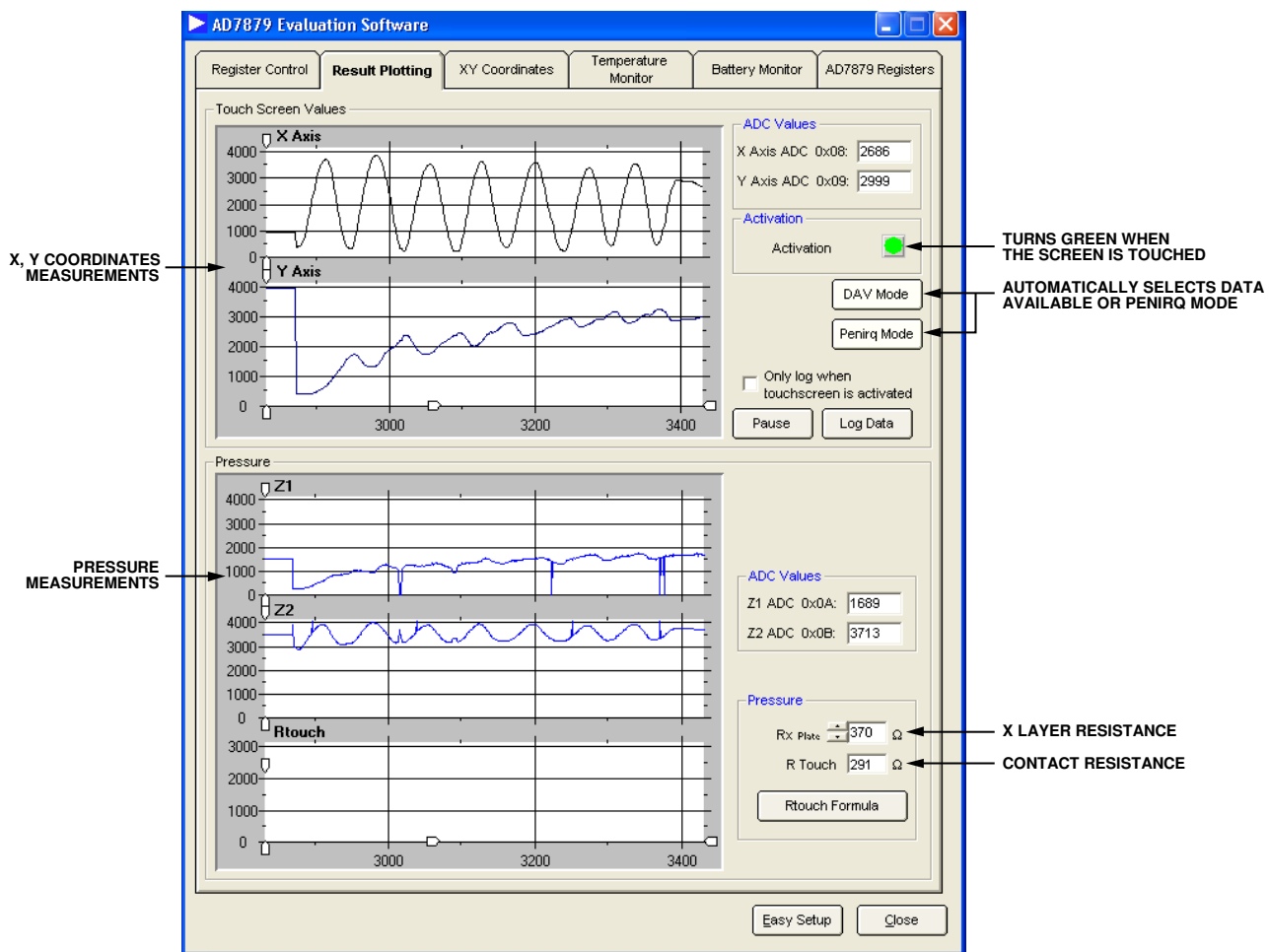

Figure 4. Result Plotting Tab

08153-004

Graphing a Measurement

Clicking the **Result Plotting** tab opens the dialog box shown in Figure 4. This box displays the measurements from the X, Y, Z1, and Z2 channels. What is graphed in this box depends on which channels are selected in the **Control Register 3 0x03** area of the **Register Control** tab. If nothing is displayed when touching the screen, click the **Register Control** tab and ensure that the corresponding channels have been selected.

The graphs in the upper portion of the box, labeled **X Axis** and **Y Axis**, represent the touch screen coordinates. The current values in the X and Y registers (Address 0x08 and Address 0x09) are shown in the corresponding **ADC Values** area. The **Activation** box illuminates green when the screen is touched, indicating that the PENIRQ signal is low.

Click **DAV Mode** or **Penirq Mode** to automatically select data available or pen interrupt mode. By clicking these buttons, the corresponding bits in Control Register 1 and Control Register 3 are automatically changed.

The graphs located in the lower section of the window display the pressure measurements obtained from the Z1 and Z2 channels. The current values in these registers (Address 0x0A and Address 0x0B) are shown in the corresponding **ADC Values** area.

The graph labeled **Rtouch** represents the contact resistance between the X and Y layers. The size of the touch resistance between both plates provides a good indication of the pressure applied to the touch screen. Click **Rtouch Formula** in the **Result Plotting** tab to display the equation used to obtain the contact resistance. The formula is shown in Figure 5.

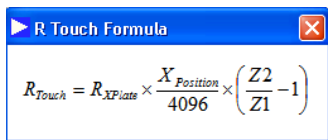

$$R_{Touch} = R_{XPlate} \times \frac{X_{Position}}{4096} \times \left(\frac{Z2}{Z1} - 1 \right)$$

Figure 5. Rtouch Formula

R_{XPlate} is the resistance of the X layer and is normally provided in the touch screen data sheet.

More details about methods to calculate R_{TOUCH} can be found in the [AD7879](#) data sheet.

Log Data

Clicking **Log Data** in the **Touch Screen Values** area of the **Result Plotting** tab opens the window shown in Figure 6. Choose the data, including the voltage measurements, the touch screen inputs, and the temperature results, to be logged to an Excel file by selecting the relevant check boxes. The interval at which data is logged can also be chosen. Click **OK** to open an Excel file and log the selected data to the file. By selecting the **Only log when touchscreen is activated** check box in the **Result Plotting** tab, measurements are only stored in the Excel file when the screen is touched.

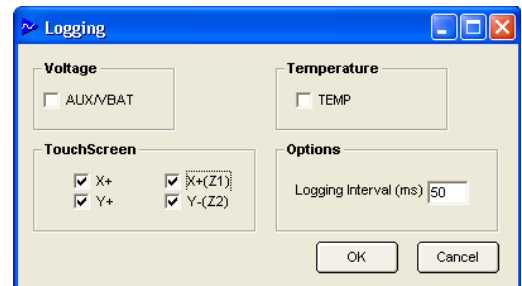

Figure 6. Logging Window

EVAL-AD7879

XY COORDINATES TAB

Clicking the **XY Coordinates** tab displays the touch screen plot, as shown in Figure 7. The X and Y coordinates from the screen are displayed here.

The window approximates a real touch screen application. If a touch screen is connected to the AD7879/AD7879-1 evaluation board, any touch on the screen is plotted in this window.

Clicking **Clear** eliminates everything written on the screen. If the **Auto clear** check box is selected, the touch screen plot is automatically cleared when your finger is removed from the touch screen.

The current X and Y ADC values are displayed in the **Coordinates** area. When the screen is touched, the **PENIRQ** signal is activated and the **Activation** box turns green, as shown in Figure 7. This tab also allows you to automatically select the interrupt mode by clicking **DAV Mode** or **Penirq Mode**.

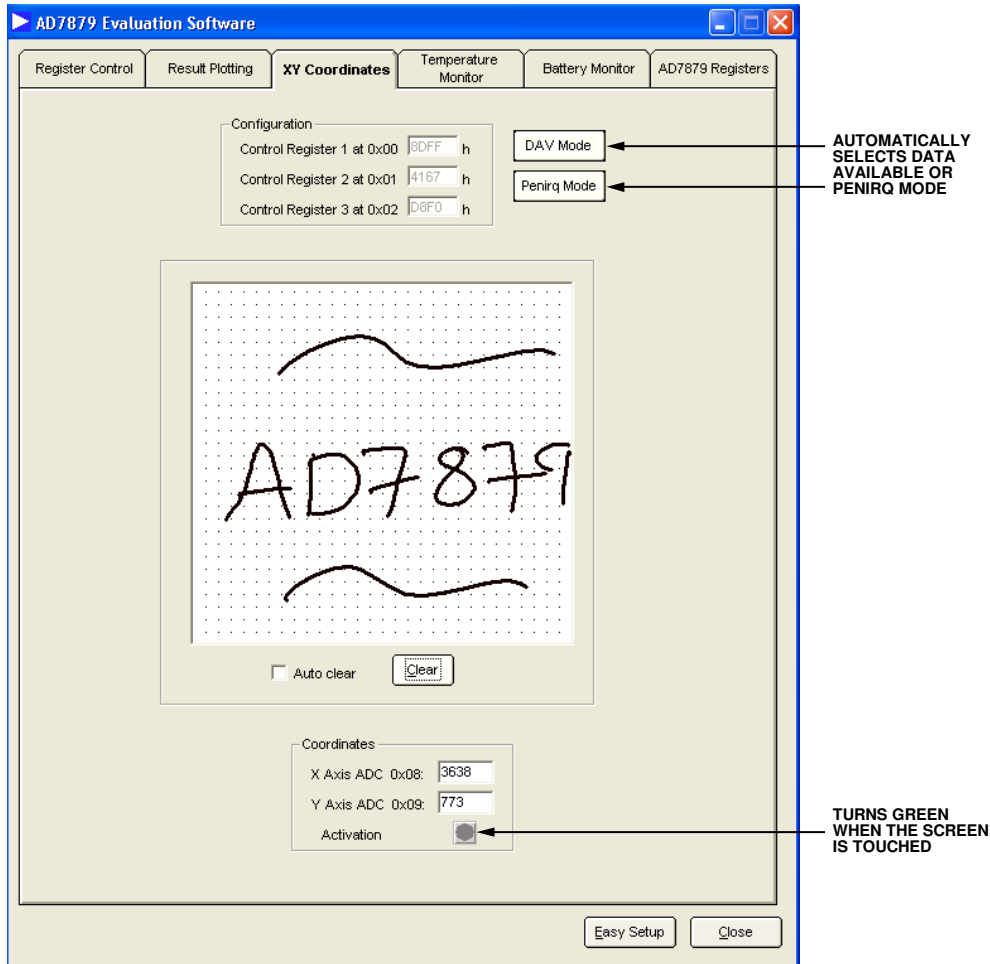

Figure 7. XY Coordinates Tab

08153-007

TEMPERATURE MONITOR TAB

Clicking the **Temperature Monitor** tab opens the dialog box shown in Figure 9. This window shows the temperature channel values and can be used to change the lower and upper temperature limits. If the temperature measurement is outside the set temperature limits, the **Temperature High Limit Threshold** or **Temperature Low Limit Threshold** box turns green.

The current temperature value and the upper and lower limits are displayed in the graphs in this window, as shown in Figure 9. The upper graph shows the ADC results of the temperature channel, and the lower graph displays the current temperature. To convert the ADC values to Celsius degrees, it is necessary to

use a formula. To view the equation, click **Temperature Formula**. The window shown in Figure 8 opens.

Temperature Formula

$$Temperature = 25^{\circ}C + (ADC_Value - 765) \times \left(\frac{V_{ref}}{4096} \times (-2.1 \times 10^{-3}) \right)$$

Figure 8. Temperature Formula

Modifying Limits

Clicking **Easy Setup** sets the upper limit to 35°C (785 decimal) and the lower limit to 17°C (740 decimal). Both the upper and the lower limits can be altered by entering new values in the boxes next to the graphs.

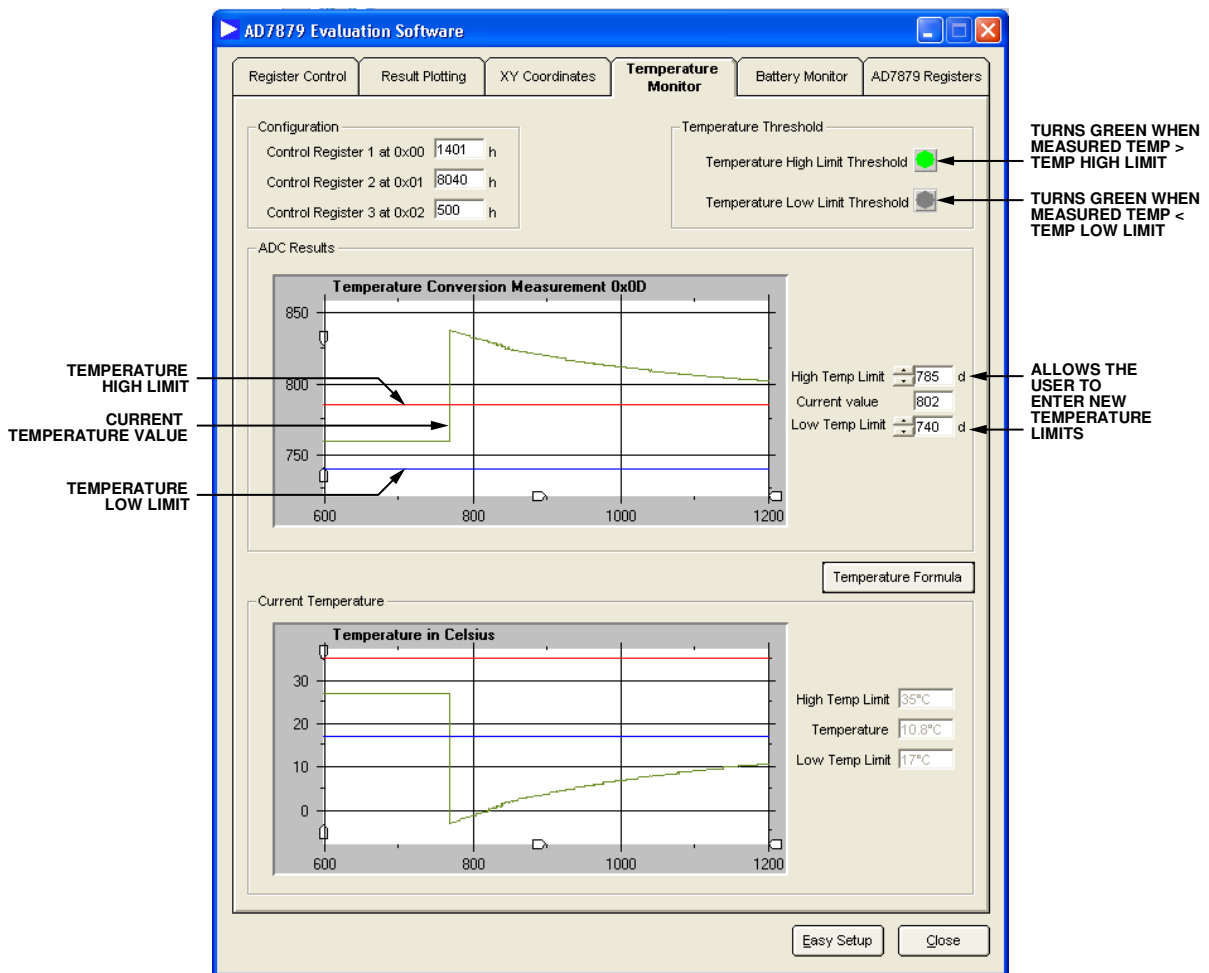

Figure 9. Temperature Monitor Tab

EVAL-AD7879

BATTERY MONITOR TAB

Using AUX/VBAT/GPIO

When Link L7 is in Position B, the AUX/VBAT/GPIO pin of the AD7879/AD7879-1 is connected to Connector J5. The AD7879/AD7879-1 measures the signal applied to J5. When Link L7 is in Position A, the AUX/VBAT/GPIO pin is connected to Variable Resistor R5; therefore, the voltage on the pin can be varied.

Clicking the **Battery Monitor** tab opens the dialog box shown in Figure 11. This dialog box allows you to change the VBAT limits and to graph the ADC measurements from the battery channel. The ADC measurements are converted to volts by

using the equation shown in Figure 10, which can be displayed by clicking **Voltage Formula** in the **Battery Monitor** tab.

$$\text{Voltage} = \text{ADC_Value} \times \frac{V_{\text{ref}}}{4096} \times 4$$

Figure 10. Voltage Formula Window

By default, the VBAT high limit threshold is set to 2.26 V, and the low limit threshold is set to 0.64 V. You can change the limits by entering new values in the boxes to the right of the graphs.

Ensure that the battery channel is enabled and that Link L7 is in Position A if you are using the R5 variable resistor.

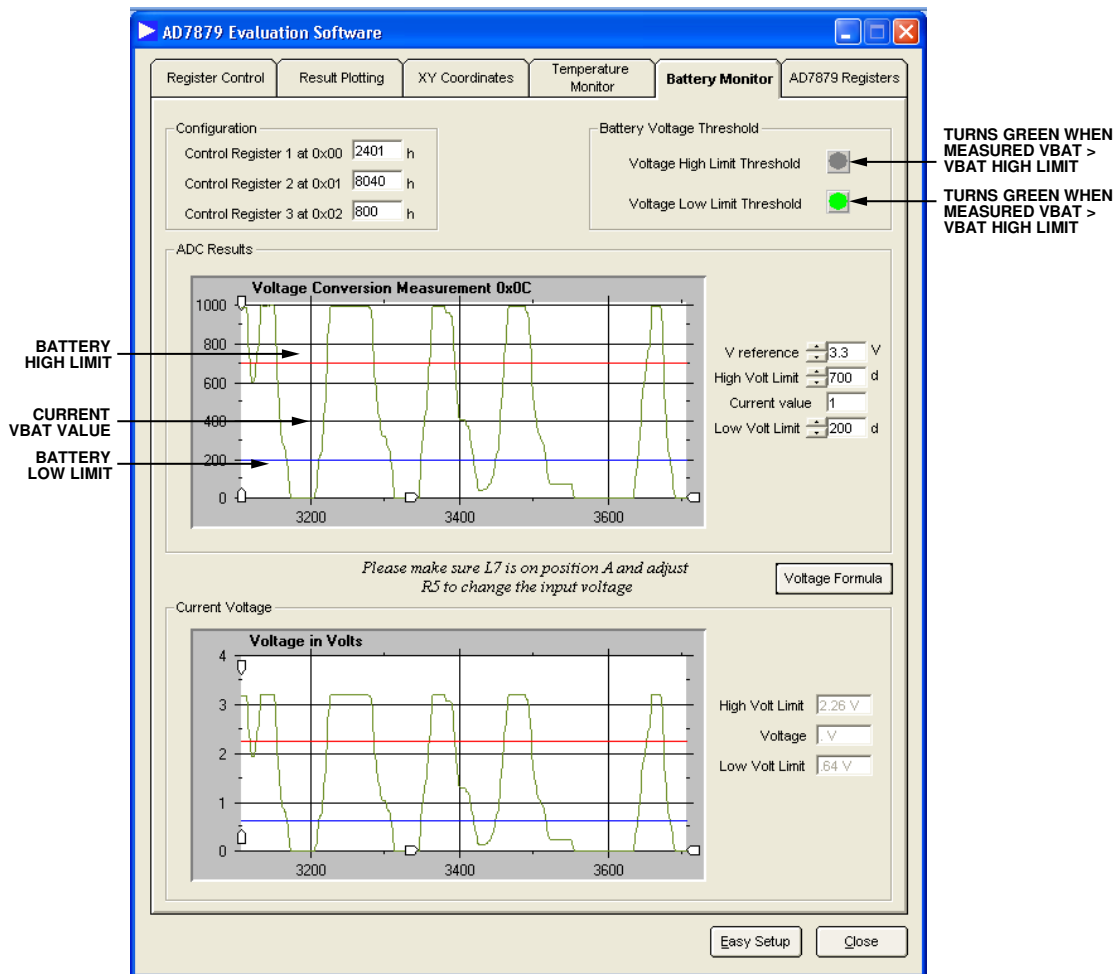

Figure 11. Battery Monitor Tab

AD7879 REGISTERS TAB

To access the AD7879/AD7879-1 registers, click the **AD7879 Registers** tab. This box allows you to read the current values of the AD7879/AD7879-1 registers and to modify the content. The label at the upper left of the dialog box indicates if the part included on the evaluation board is AD7879 (SPI interface) or AD7879-1 (I²C interface). The content of the register map is shown in the upper portion of the window. Note that some of

the registers values are given in hexadecimal format (h) and others are in decimal format (d).

You can read from or write to a specific register by typing the address in the **Register Address** box and the value in the **Register Data** box, and then clicking **Read** or **Write**. The values can be entered in either hexadecimal or decimal format.

If the evaluation board contains an SPI part, you can modify the SPI clock frequency from 400 kHz to 5 MHz by using the slider located in the lower section of the window.

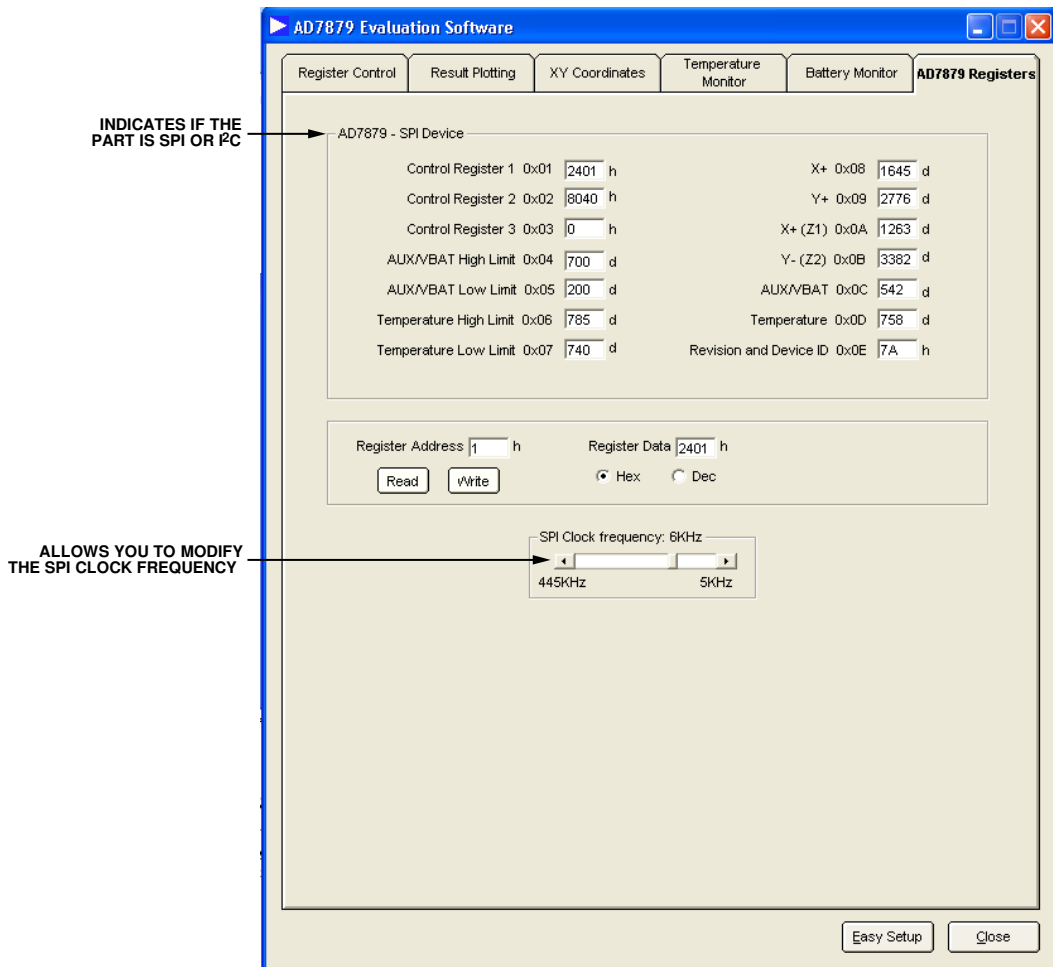

Figure 12. AD7879 Registers Tab

EVALUATION BOARD SCHEMATICS AND ARTWORK

08153-013

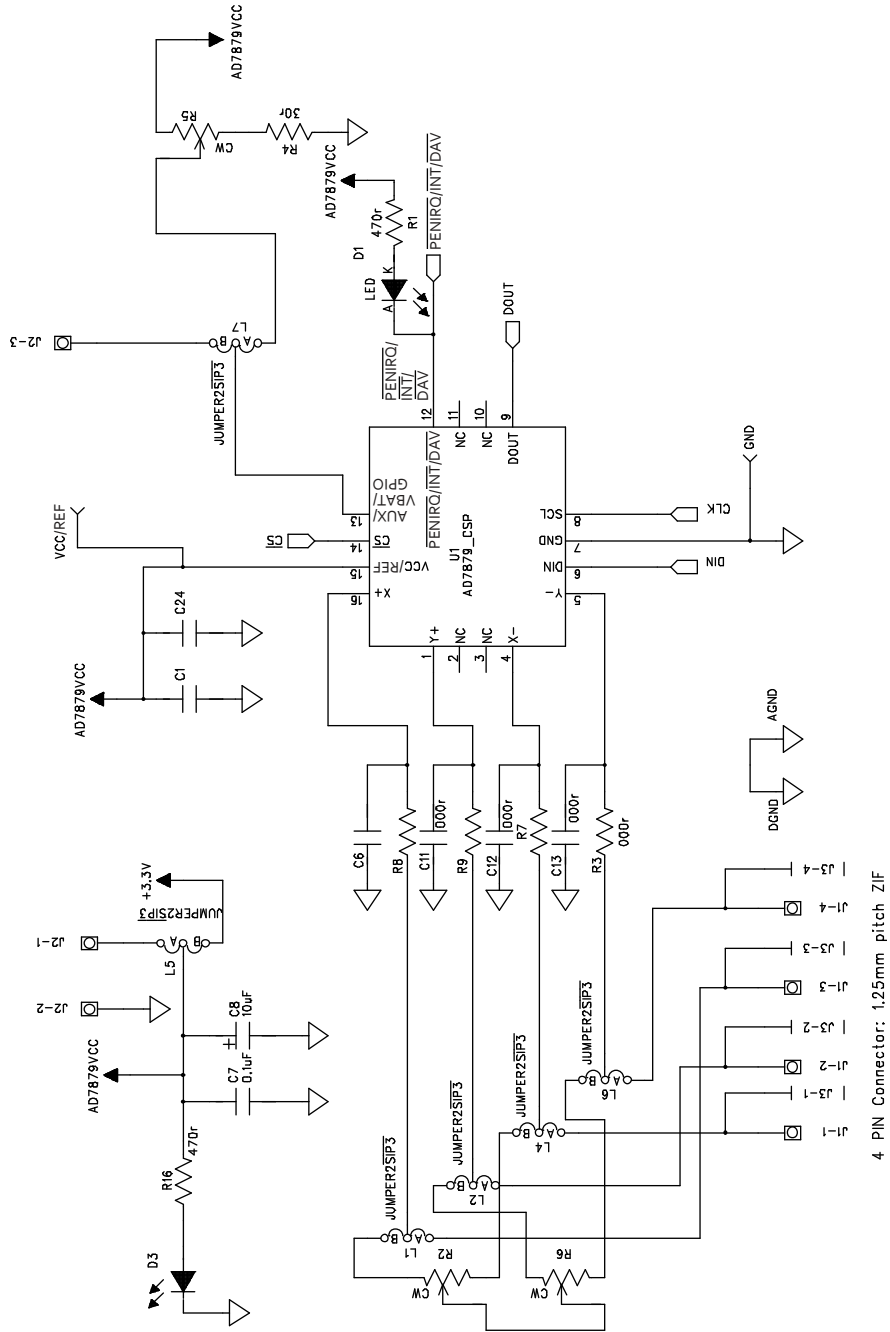

Figure 13. Evaluation Board Schematic, AD7879/AD7879-1 Section

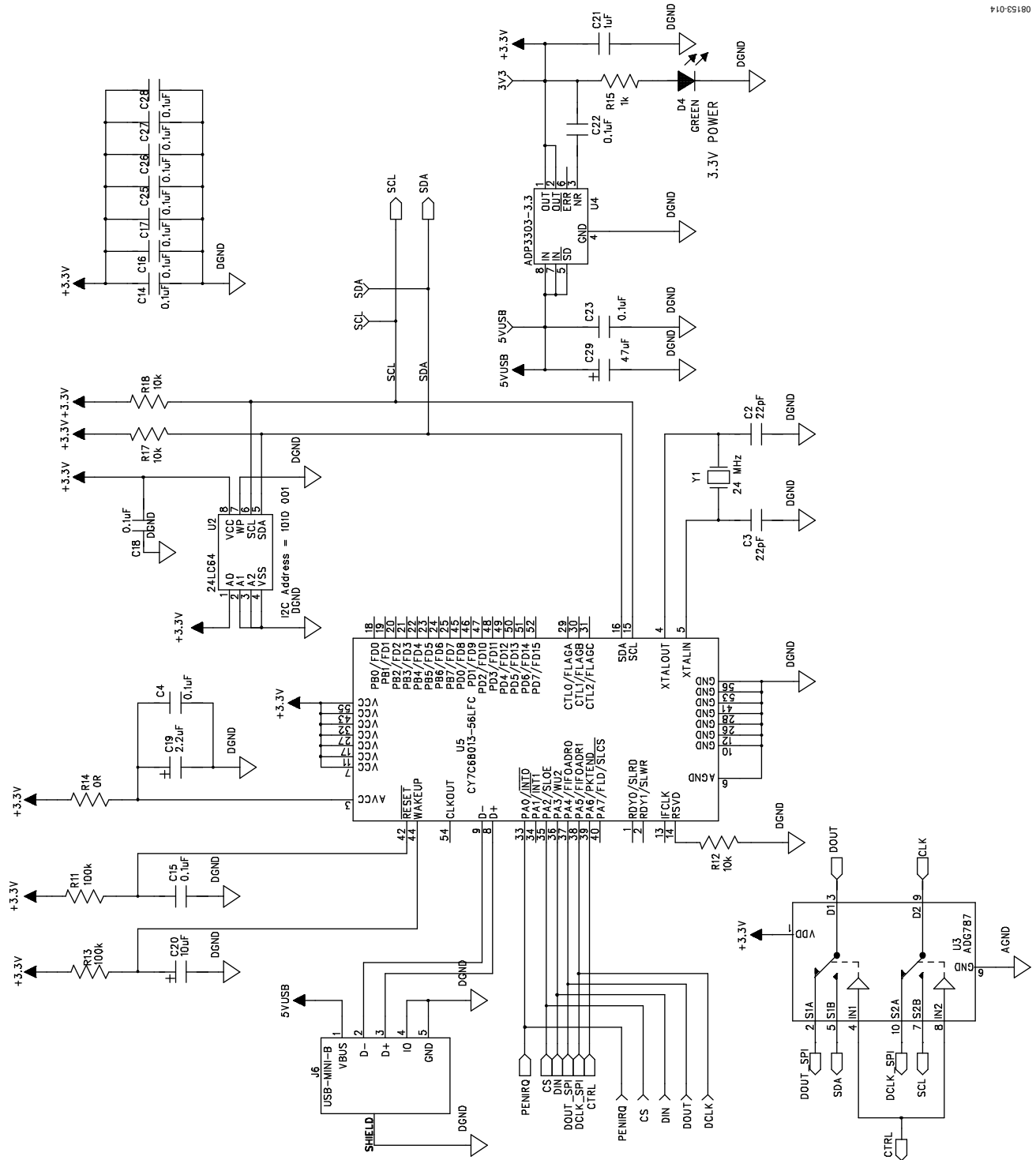

Figure 14. AD7879/AD7879-1 Evaluation Board Schematic, USB Section

EVAL-AD7879

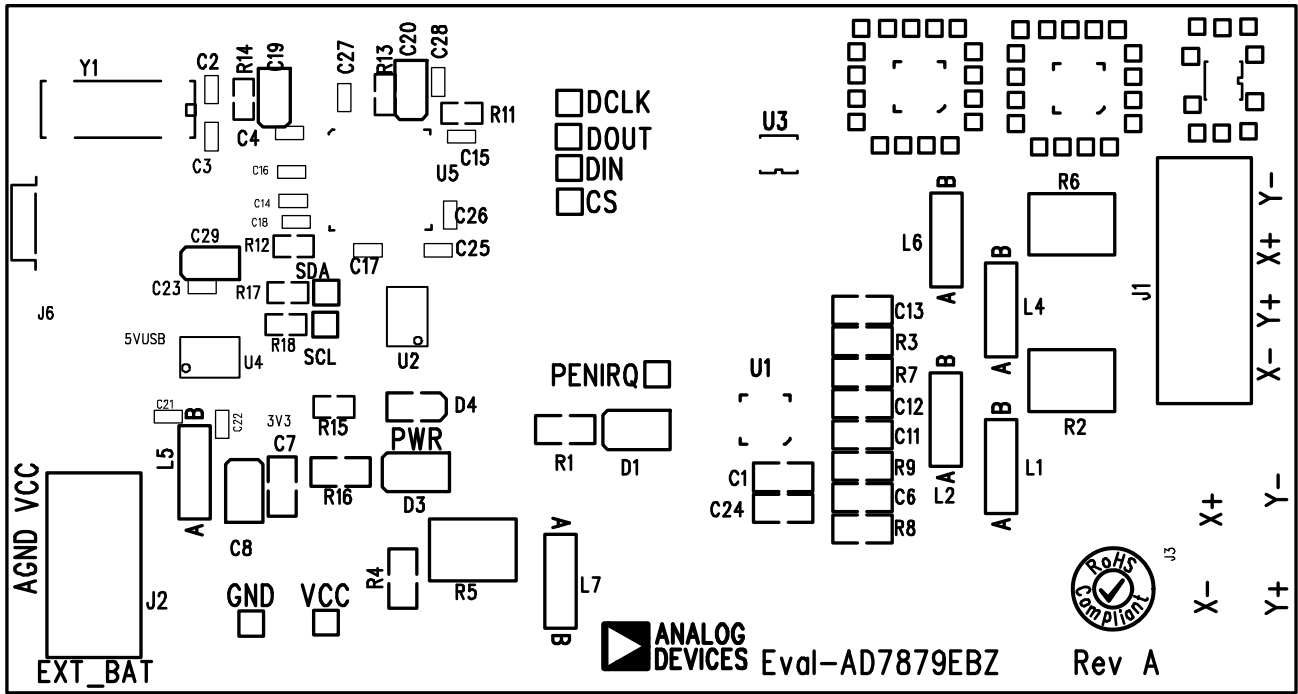

Figure 15. AD7879 Evaluation Board Silkscreen

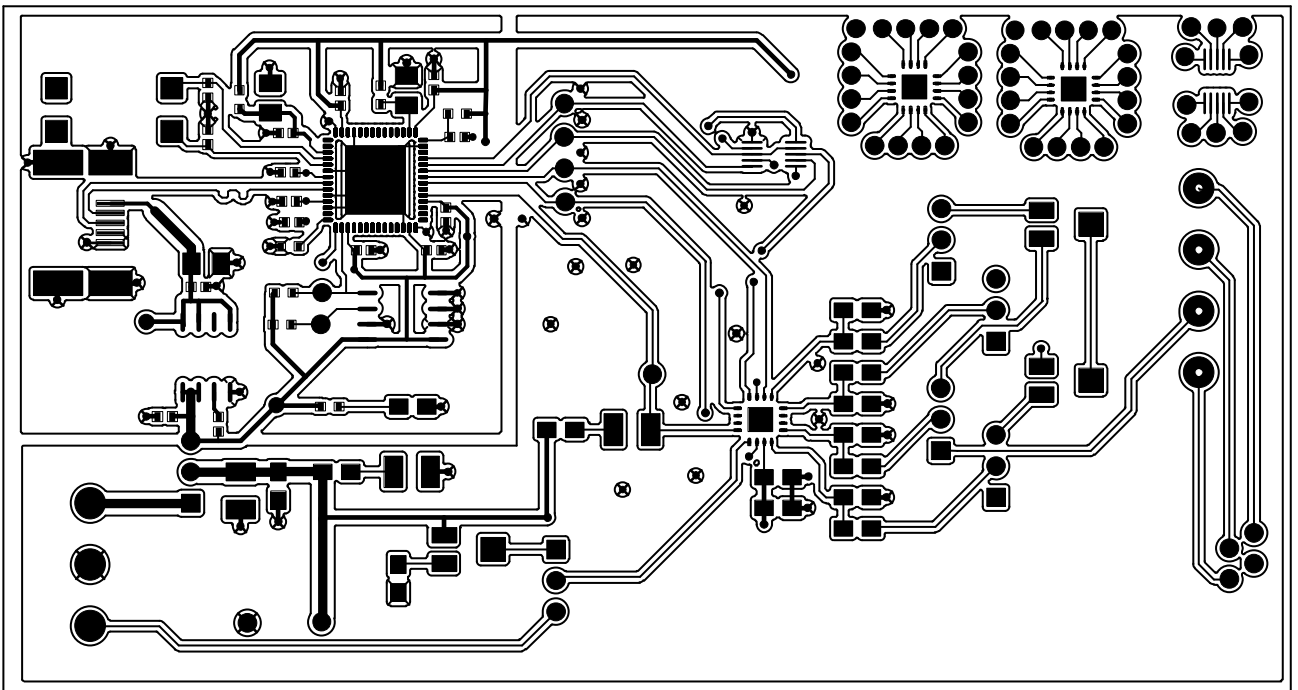
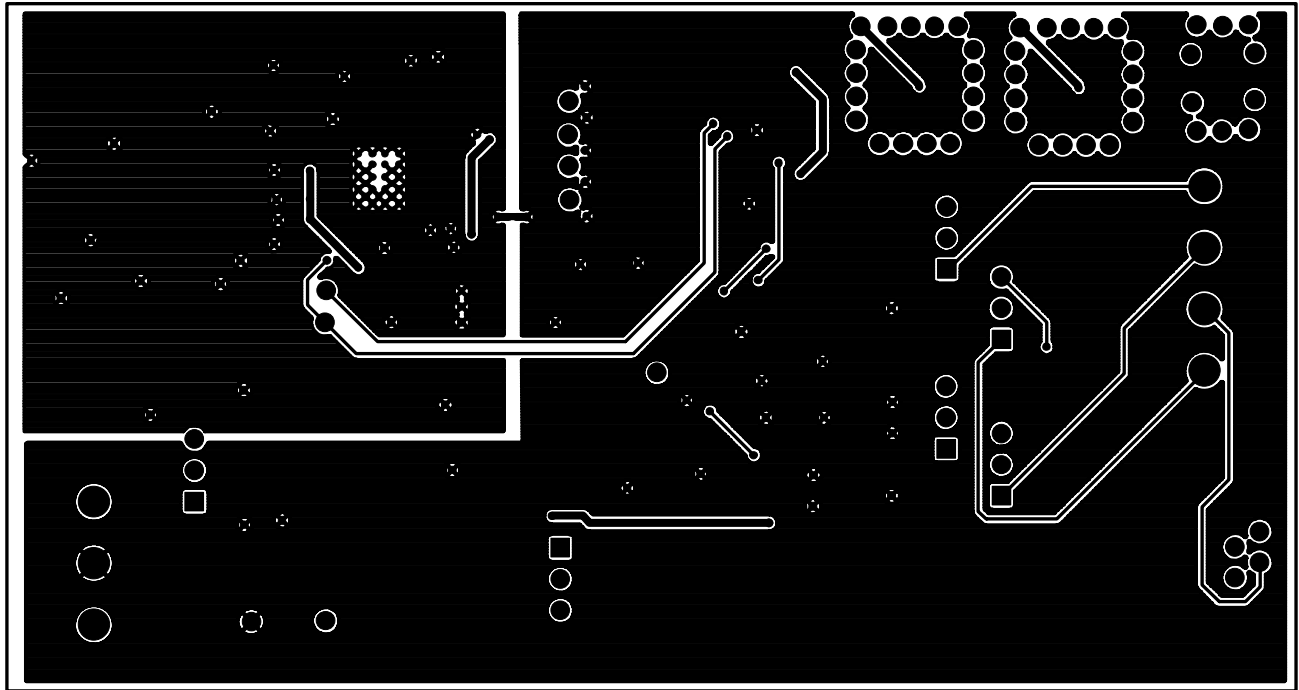

Figure 16. AD7879/AD7879-1 Evaluation Board, Component Side



08153-017

Figure 17. AD7879/AD7879-1 Evaluation Board, Solder Side

EVAL-AD7879

ORDERING INFORMATION

ORDERING GUIDE

| Model | Description |
|-------------------------------|---|
| EVAL-AD7879EBZ ¹ | SPI Interface Evaluation Board |
| EVAL-AD7879-1EBZ ¹ | I ² C Interface Evaluation Board |

¹ Z = RoHS Compliant Part.

ESD CAUTION



ESD (electrostatic discharge) sensitive device. Charged devices and circuit boards can discharge without detection. Although this product features patented or proprietary protection circuitry, damage may occur on devices subjected to high energy ESD. Therefore, proper ESD precautions should be taken to avoid performance degradation or loss of functionality.

NOTES

EVAL-AD7879

NOTES