

March 1993

Features

- Wide Operating Voltage Range $\pm 1V$ to $\pm 8V$
- High Input Impedance $10^{12} \Omega$
- Input Current Lower Than BIFETs 1pA Typ
- Output Voltage Swing $V+$ and $V-$
- Available as Duals and Quads (Refer to ICL7611 for Singles)
- Low Power Replacement for Many Standard Op Amps

Applications

- Portable Instruments
- Telephone Headsets
- Hearing Aid/Microphone Amplifiers
- Meter Amplifiers
- Medical Instruments
- High Impedance Buffers

Description

The ICL761X/762X/764X series is a family of monolithic CMOS operational amplifiers. These devices provide the designer with high performance operation at low supply voltages and selectable quiescent currents. They are an ideal design tool when ultra low input current and low power dissipation are desired.

The basic amplifier will operate at supply voltages ranging from $\pm 1V$ to $\pm 8V$, and may be operated from a single Lithium cell. The output swing ranges to within a few millivolts of the supply voltages.

The quiescent supply current of these amplifiers is set to 3 different ranges at the factory. Both amps of the dual ICL7621 are set to an I_Q of $100\mu A$, while each amplifier of the quad ICL7641 and ICL7642 are set to an I_Q of 1mA and $10\mu A$ respectively. This results in power consumption as low as $20\mu W$ per amplifier.

Of particular significance is the extremely low (1pA) input current, input noise current of $0.01pA/\sqrt{Hz}$, and $10^{12}\Omega$ input impedance. These features optimize performance in very high source impedance applications.

The inputs are internally protected. Outputs are fully protected against short circuits to ground or to either supply.

AC performance is excellent, with a slew rate of $1.6V/\mu s$, and unity gain bandwidth of 1MHz at $I_Q = 1mA$.

Because of the low power dissipation, junction temperature rise and drift are quite low. Applications utilizing these features may include stable instruments, extended life designs, or high density packages.

Pinouts (See Ordering Information on Next Page)

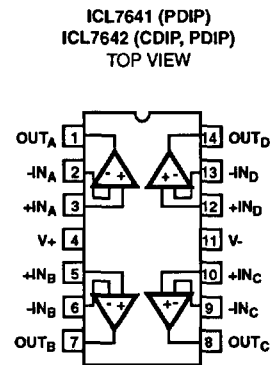
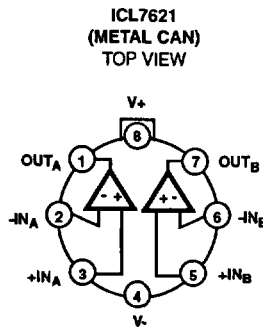
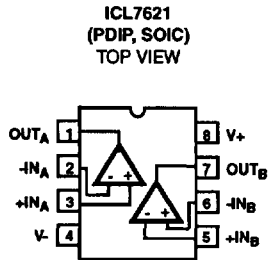

ICL7621, ICL7641, ICL7642

Ordering Information

PART NUMBER	TEMPERATURE RANGE	PACKAGE
ICL7621ACPA	0°C to +70°C	8 Lead Plastic DIP - A Grade - $I_Q = 100\mu A$
ICL7621BCPA	0°C to +70°C	8 Lead Plastic DIP - B Grade - $I_Q = 100\mu A$
ICL7621DCPA	0°C to +70°C	8 Lead Plastic DIP - D Grade - $I_Q = 100\mu A$
ICL7621ACTV	0°C to +70°C	8 Pin TO-99 Metal Can - A Grade - $I_Q = 100\mu A$
ICL7621BCTV	0°C to +70°C	8 Pin TO-99 Metal Can - B Grade - $I_Q = 100\mu A$
ICL7621DCTV	0°C to +70°C	8 Pin TO-99 Metal Can - D Grade - $I_Q = 100\mu A$
ICL7621AMTV	-55°C to +125°C	8 Pin TO-99 Metal Can - A Grade - $I_Q = 100\mu A$
ICL7621BMTV	-55°C to +125°C	8 Pin TO-99 Metal Can - B Grade - $I_Q = 100\mu A$
ICL7621DMTV	-55°C to +125°C	8 Pin TO-99 Metal Can - D Grade - $I_Q = 100\mu A$
ICL7621DCBA	0°C to +70°C	8 Lead SOIC - D Grade - $I_Q = 100\mu A$
ICL7621DCBA-T	0°C to +70°C	8 Lead SOIC - D Grade - Tape and Reel - $I_Q = 100\mu A$
ICL7641CCPD	0°C to +70°C	14 Lead Plastic DIP - C Grade - $I_Q = 1mA$
ICL7641ECPD	0°C to +70°C	14 Lead Plastic DIP - E Grade - $I_Q = 1mA$
ICL7642CCPD	0°C to +70°C	14 Lead Plastic DIP - C Grade - $I_Q = 10\mu A$
ICL7642ECPD	0°C to +70°C	14 Lead Plastic DIP - E Grade - $I_Q = 10\mu A$
ICL7642CCJD	0°C to +70°C	14 Lead Ceramic DIP - C Grade - $I_Q = 10\mu A$
ICL7642CMJD	-55°C to +125°C	14 Lead Ceramic DIP - C Grade - $I_Q = 10\mu A$
ICL7642EMJD	-55°C to +125°C	14 Lead Ceramic DIP - E Grade - $I_Q = 10\mu A$

2

**OPERATIONAL
AMPLIFIERS**

Specifications ICL7621, ICL7641, ICL7642

Absolute Maximum Ratings

Supply Voltage V+ to V- 18V
 Input Voltage V- -0.3 to V+ +0.3V
 Differential Input Voltage (Note 1) [(V+ +0.3) - (V- -0.3)]V
 Duration of Output Short Circuit (Note 2) Unlimited
Power Dissipation
 8 Lead Mini Dip and TO-99:
 At T_A = +25°C 250mW
 Above T_A = +25°C Derate Linearly 2mW/°C
 14 Lead Plastic DIP:
 At T_A = +25°C 375mW
 Above T_A = +25°C Derate Linearly 3mW/°C
 14 Lead Ceramic DIP:
 At T_A = +25°C 500mW
 Above T_A = +25°C Derate Linearly 4mW/°C
 Junction Temperature +175°C
 Junction Temperature (Plastic Package) +150°C
 Lead Temperature (Soldering 10 Sec.) +300°C

Operating Conditions

Operating Temperature Range
 ICL76XXM -55°C ≤ T_A ≤ +125°C
 ICL76XXC 0°C ≤ T_A ≤ +70°C
 Storage Temperature Range -65°C ≤ T_A ≤ +150°C

CAUTION: Stresses above those listed in "Absolute Maximum Ratings" may cause permanent damage to the device. This is a stress only rating and operation of the device at these or any other conditions above those indicated in the operational sections of this specification is not implied.

Electrical Specifications V_{SUPPLY} = ±5.0V, T_A = +25°C, Unless Otherwise Specified

PARAMETERS	SYMBOL	TEST CONDITIONS	ICL7621A			ICL7621B			ICL7621D			UNITS	
			MIN	TYP	MAX	MIN	TYP	MAX	MIN	TYP	MAX		
Input Offset Voltage	V _{OS}	R _S ≤ 100kΩ T _A = +25°C	-	-	2	-	-	5	-	-	15	mV	
			T _{MIN} ≤ T _A ≤ T _{MAX}	-	-	3	-	-	7	-	-	20	mV
Temperature Coefficient of V _{OS}	ΔV _{OS} /ΔT	R _S ≤ 100kΩ	-	10	-	-	15	-	-	25	-	μV/°C	
Input Offset Current	I _{OS}	T _A = +25°C	-	0.5	30	-	0.5	30	-	0.5	30	pA	
		0°C to +70°C	-	-	300	-	-	300	-	-	300	pA	
		-55°C to +125°C	-	-	800	-	-	800	-	-	800	pA	
Input Bias Current	I _{BIAS}	T _A = +25°C	-	1.0	50	-	1.0	50	-	1.0	50	pA	
		0°C to +70°C	-	-	400	-	-	400	-	-	400	pA	
		-55°C to +125°C	-	-	4000	-	-	4000	-	-	4000	pA	
Common Mode Voltage Range	V _{CMR}	I _O = 100μA	±4.2	-	-	±4.2	-	-	±4.2	-	-	V	
Output Voltage Swing	V _{OUT}	I _O = 100μA, R _L = 100kΩ	T _A = +25°C	±4.9	-	-	±4.9	-	-	±4.9	-	-	V
			0°C to 70°C	±4.8	-	-	±4.8	-	-	±4.8	-	-	V
			-55°C to +125°C	±4.5	-	-	±4.5	-	-	±4.5	-	-	V
Large Signal Voltage Gain	A _{VOL}	V _O = ±4.0V, R _L = 100kΩ, I _O = 100μA	T _A = +25°C	86	102	-	80	102	-	80	102	-	dB
			0°C to +70°C	80	-	-	75	-	-	75	-	-	dB
			-55°C to +125°C	74	-	-	68	-	-	68	-	-	dB
Unity Gain Bandwidth	GBW	I _O = 100μA	-	0.48	-	-	0.48	-	-	0.48	-	MHz	
Input Resistance	R _{IN}		-	10 ¹²	-	-	10 ¹²	-	-	10 ¹²	-	Ω	
Common Mode Rejection Ratio	CMRR	R _S ≤ 100kΩ, I _O = 100μA	76	91	-	70	91	-	70	91	-	dB	

Specifications ICL7621, ICL7641, ICL7642

Electrical Specifications $V_{SUPPLY} = \pm 5.0V$, $T_A = +25^\circ C$, Unless Otherwise Specified (Continued)

PARAMETERS	SYMBOL	TEST CONDITIONS	ICL7621A			ICL7621B			ICL7621D			UNITS
			MIN	TYP	MAX	MIN	TYP	MAX	MIN	TYP	MAX	
Power Supply Rejection Ratio $V_{SUPPLY} = \pm 8V$ to $\pm 2V$	PSRR	$R_S \leq 100k\Omega$, $I_Q = 100\mu A$	80	86	-	80	86	-	80	86	-	dB
Input Referred Noise Voltage	e_N	$R_S = 100\Omega$, $f = 1kHz$	-	100	-	-	100	-	-	100	-	nV/\sqrt{Hz}
Input Referred Noise Current	i_N	$R_S = 100\Omega$, $f = 1kHz$	-	0.01	-	-	0.01	-	-	0.01	-	pA/\sqrt{Hz}
Supply Current (per Amplifier)	I_{SUPPLY}	No Signal, No Load, $I_Q = 100\mu A$	-	0.1	0.25	-	0.1	0.25	-	0.1	0.25	mA
Channel Separation	V_{O1}/V_{O2}	$A_V = 100$	-	120	-	-	120	-	-	120	-	dB
Slew Rate	SR	$A_V = 1$, $C_L = 100pF$ $V_{IN} = 8Vp-p$, $I_Q = 100\mu A$, $R_L = 100k\Omega$	-	0.16	-	-	0.16	-	-	0.16	-	$V/\mu s$
Rise Time	t_R	$V_{IN} = 50mV$, $C_L = 100pF$ $I_Q = 100\mu A$, $R_L = 100k\Omega$	-	2	-	-	2	-	-	2	-	μs
Overshoot Factor	OS	$V_{IN} = 50mV$, $C_L = 100pF$ $I_Q = 100\mu A$, $R_L = 100k\Omega$	-	10	-	-	10	-	-	10	-	%

NOTES:

1. Long term offset voltage stability will be degraded if large input differential voltages are applied for long periods of time.
2. The outputs may be shorted to ground or to either supply, for $V_{SUPPLY} \leq 10V$. Care must be taken to insure that the dissipation rating is not exceeded.

Electrical Specifications $V_{SUPPLY} = \pm 5.0V$, $T_A = +25^\circ C$, Unless Otherwise Specified

PARAMETERS	SYMBOL	TEST CONDITIONS	ICL7641C, ICL7642C			ICL7641E, ICL7642E			UNITS	
			MIN	TYP	MAX	MIN	TYP	MAX		
Input Offset Voltage	V_{OS}	$R_S \leq 100k\Omega$	$T_A = +25^\circ C$	-	-	10	-	-	20	mV
			$T_{MIN} \leq T_A \leq T_{MAX}$	-	-	15	-	-	25	mV
Temperature Coefficient of V_{OS}	$\Delta V_{OS}/\Delta T$	$R_S \leq 100k\Omega$	-	20	-	-	30	-	$\mu V/^\circ C$	
Input Offset Current	I_{OS}	$T_A = +25^\circ C$	$T_A = +25^\circ C$	-	0.5	30	-	0.5	30	pA
			$0^\circ C$ to $+70^\circ C$	-	-	300	-	-	300	pA
			$-55^\circ C$ to $+125^\circ C$	-	-	800	-	-	800	pA
Input Bias Current	I_{BIAS}	$T_A = +25^\circ C$	$T_A = +25^\circ C$	-	1.0	50	-	1.0	50	pA
			$0^\circ C$ to $+70^\circ C$	-	-	500	-	-	500	pA
			$-55^\circ C$ to $+125^\circ C$	-	-	4000	-	-	4000	pA
Common Mode Voltage Range	V_{CMR}	$I_Q = 10\mu A$, ICL7642	± 4.4	-	-	± 4.4	-	-	V	
		$I_Q = 1mA$, ICL7641	± 3.7	-	-	± 3.7	-	-	V	

2

OPERATIONAL AMPLIFIERS

Specifications ICL7621, ICL7641, ICL7642

Electrical Specifications $V_{SUPPLY} = \pm 5.0V$, $T_A = +25^\circ C$, Unless Otherwise Specified (Continued)

PARAMETERS	SYMBOL	TEST CONDITIONS		ICL7641C, ICL7642C			ICL7641E, ICL7642E			UNITS
				MIN	TYP	MAX	MIN	TYP	MAX	
Output Voltage Swing	V_{OUT}	ICL7642, $I_Q = 10\mu A$, $R_L = 1M\Omega$,	$T_A = +25^\circ C$	± 4.9	-	-	± 4.9	-	-	V
			$0^\circ C$ to $70^\circ C$	± 4.8	-	-	± 4.8	-	-	V
			$-55^\circ C$ to $+125^\circ C$	± 4.7	-	-	± 4.7	-	-	V
		ICL7641, $I_Q = 1mA$, $R_L = 10k\Omega$,	$T_A = +25^\circ C$	± 4.5	-	-	± 4.5	-	-	V
			$0^\circ C$ to $70^\circ C$	± 4.3	-	-	± 4.3	-	-	V
			$-55^\circ C$ to $+125^\circ C$	± 4.0	-	-	± 4.0	-	-	V
Large Signal Voltage Gain	A_{VOL}	ICL7642, $V_O = \pm 4.0V$, $R_L = 1M\Omega$, $I_Q = 10\mu A$	$T_A = +25^\circ C$	80	104	-	80	104	-	dB
			$0^\circ C$ to $70^\circ C$	75	-	-	75	-	-	dB
			$-55^\circ C$ to $+125^\circ C$	68	-	-	68	-	-	dB
		ICL7641, $V_O = \pm 4.0V$, $R_L = 10k\Omega$, $I_Q = 1mA$	$T_A = +25^\circ C$	76	98	-	76	98	-	dB
			$0^\circ C$ to $70^\circ C$	72	-	-	72	-	-	dB
			$-55^\circ C$ to $+125^\circ C$	68	-	-	68	-	-	dB
Unity Gain Bandwidth	GBW	ICL 7642, $I_Q = 10\mu A$		-	0.044	-	-	0.044	-	MHz
		ICL 7641, $I_Q = 1mA$		-	1.4	-	-	1.4	-	MHz
Input Resistance	R_{IN}			-	10^{12}	-	-	10^{12}	-	Ω
Common Mode Rejection Ratio	CMRR	ICL7642, $R_S \leq 100k\Omega$, $I_Q = 10\mu A$		70	96	-	70	96	-	dB
		ICL7641, $R_S \leq 100k\Omega$, $I_Q = 1mA$		60	87	-	60	87	-	dB
Power Supply Rejection Ratio $V_{SUPPLY} = \pm 8V$ to $\pm 2V$	PSRR	ICL7642, $R_S \leq 100k\Omega$, $I_Q = 10\mu A$		80	94	-	80	94	-	dB
		ICL7641, $R_S \leq 100k\Omega$, $I_Q = 1mA$		70	77	-	70	77	-	dB
Input Referred Noise Voltage	e_N	$R_S = 100\Omega$, $f = 1kHz$		-	100	-	-	100	-	nV/\sqrt{Hz}
Input Referred Noise Current	i_N	$R_S = 100\Omega$, $f = 1kHz$		-	0.01	-	-	0.01	-	pA/\sqrt{Hz}
Supply Current (per Amplifier)	I_{SUPPLY}	No Signal, No Load	ICL7642, $I_Q = 10\mu A$ Low Bias	-	0.01	0.03	-	0.01	0.03	mA
			ICL7641, $I_Q = 1mA$ High Bias	-	1.0	2.5	-	1.0	2.5	mA
Channel Separation	V_{O1}/V_{O2}	$A_V = 100$		-	120	-	-	120	-	dB
Slew Rate	SR	$A_V = 1$, $C_L = 100pF$, $V_{IN} = 8V_{P-P}$	ICL7642, $I_Q = 10\mu A$, $R_L = 1M\Omega$	-	0.016	-	-	0.016	-	$V/\mu s$
			ICL7641, $I_Q = 1mA$, $R_L = 10k\Omega$	-	1.6	-	-	1.6	-	$V/\mu s$
Rise Time	t_R	$V_{IN} = 50mV$, $C_L = 100pF$	ICL7642, $I_Q = 10\mu A$, $R_L = 1M\Omega$	-	20	-	-	20	-	μs
			ICL7641, $I_Q = 1mA$, $R_L = 10k\Omega$	-	0.9	-	-	0.9	-	μs

Specifications ICL7621, ICL7641, ICL7642

Electrical Specifications $V_{SUPPLY} = \pm 5.0V, T_A = +25^\circ C$, Unless Otherwise Specified (Continued)

PARAMETERS	SYMBOL	TEST CONDITIONS	ICL7641C, ICL7642C			ICL7641E, ICL7642E			UNITS	
			MIN	TYP	MAX	MIN	TYP	MAX		
Overshoot Factor	OS	$V_{IN} = 50mV,$ $C_L = 100pF$	ICL7642, $I_Q = 10\mu A,$ $R_L = 1M\Omega$	-	5	-	-	5	-	%
			ICL7641, $I_Q = 1mA,$ $R_L = 10k\Omega$	-	40	-	-	40	-	%

NOTES:

1. Long term offset voltage stability will be degraded if large input differential voltages are applied for long periods of time.
2. The outputs may be shorted to ground or to either supply, for $V_{SUPPLY} \leq 10V$. Care must be taken to insure that the dissipation rating is not exceeded.

Electrical Specifications $V_{SUPPLY} = \pm 1.0V, I_Q = 10\mu A, T_A = +25^\circ C$, Unless Otherwise Specified

PARAMETERS	SYMBOL	TEST CONDITIONS	ICL7642C			UNITS	
			MIN	TYP	MAX		
Input Offset Voltage	V_{OS}	$R_S \leq 100k\Omega$	$T_A = +25^\circ C$	-	-	10	mV
			$T_{MIN} \leq T_A \leq T_{MAX}$	-	-	12	mV
Temperature Coefficient of V_{OS}	$\Delta V_{OS}/\Delta T$	$R_S \leq 100k\Omega$	-	20	-	$\mu V/^\circ C$	
Input Offset Current	I_{OS}	$T_A = +25^\circ C$ $0^\circ C$ to $+70^\circ C$	$T_A = +25^\circ C$	-	0.5	30	pA
			$0^\circ C$ to $+70^\circ C$	-	-	300	pA
Input Bias Current	I_{BIAS}	$T_A = +25^\circ C$ $0^\circ C$ to $+70^\circ C$	$T_A = +25^\circ C$	-	1.0	50	pA
			$0^\circ C$ to $+70^\circ C$	-	-	500	pA
Common Mode Voltage Range	V_{CMR}		± 0.6	-	-	V	
Output Voltage Swing	V_{OUT}	$R_L = 1M\Omega$	$T_A = +25^\circ C$	-	± 0.98	-	V
			$0^\circ C$ to $70^\circ C$	-	± 0.96	-	V
Large Signal Voltage Gain	A_{VOL}	$V_O = \pm 0.1V,$ $R_L = 1M\Omega$	$T_A = +25^\circ C$	-	90	-	dB
			$0^\circ C$ to $+70^\circ C$	-	80	-	dB
Unity Gain Bandwidth	GBW		-	0.044	-	MHz	
Input Resistance	R_{IN}		-	10^{12}	-	Ω	
Common Mode Rejection Ratio	CMRR	$R_S \leq 100k\Omega$	-	80	-	dB	
Power Supply Rejection Ratio	PSRR		-	80	-	dB	
Input Referred Noise Voltage	e_N	$R_S = 100\Omega, f = 1kHz$	-	100	-	nV/\sqrt{Hz}	
Input Referred Noise Current	i_N	$R_S = 100\Omega, f = 1kHz$	-	0.01	-	pA/\sqrt{Hz}	
Supply Current (Per Amplifier)	I_{SUPPLY}	No Signal, No Load	-	6	15	μA	
Channel Separation	V_{O1}/V_{O2}	$A_V = 100$	-	120	-	dB	
Slew Rate	SR	$A_V = 1, C_L = 100pF, V_{IN} = 0.2V_{P-P},$ $R_L = 1M\Omega$	-	0.016	-	$V/\mu s$	
Rise Time	t_R	$V_{IN} = 50mV, C_L = 100pF, R_L = 1M\Omega$	-	20	-	μs	
Overshoot Factor	OS	$V_{IN} = 50mV, C_L = 100pF, R_L = 1M\Omega$	-	5	-	%	

2

OPERATIONAL AMPLIFIERS

Functional Diagram

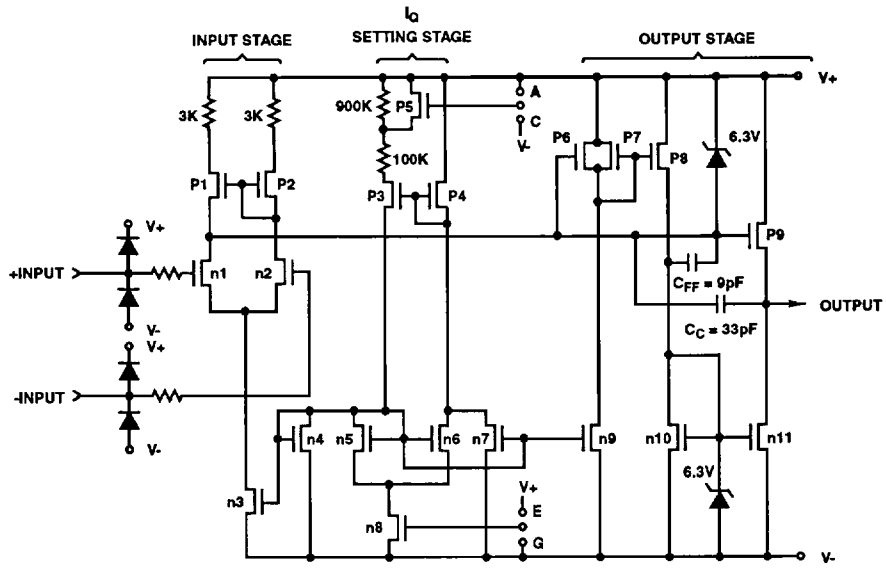

TABLE OF JUMPERS		I_Q
ICL7621	C, E	100 μ A
ICL7641	C, G	1mA
ICL7642	A, E	10 μ A

Typical Performance Curves

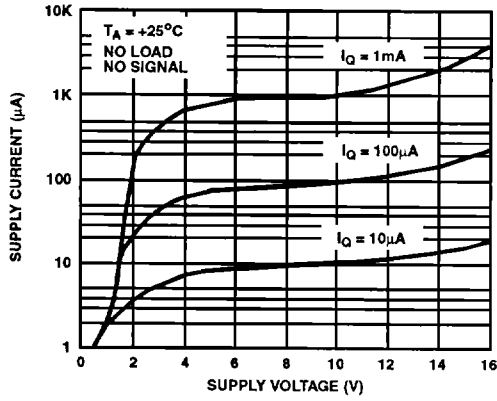

FIGURE 1. SUPPLY CURRENT PER AMPLIFIER vs SUPPLY VOLTAGE

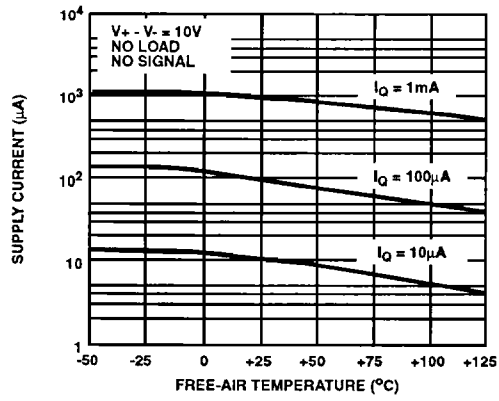

FIGURE 2. SUPPLY CURRENT PER AMPLIFIER vs FREE-AIR TEMPERATURE

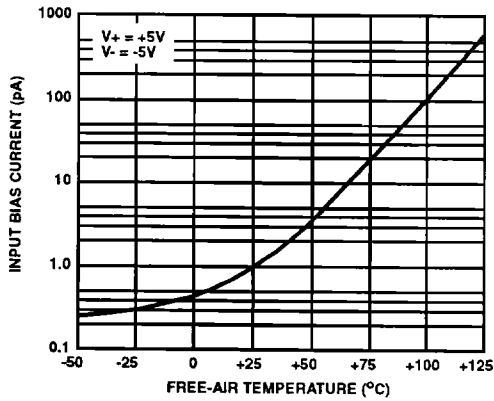

FIGURE 3. INPUT BIAS CURRENT vs TEMPERATURE

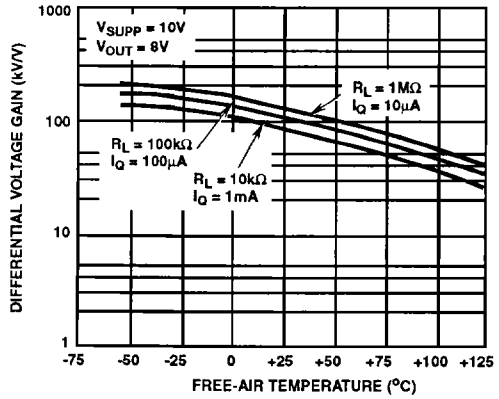

FIGURE 4. LARGE SIGNAL DIFFERENTIAL VOLTAGE GAIN vs FREE-AIR TEMPERATURE

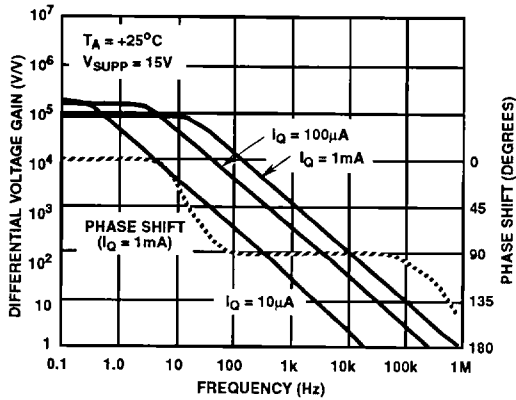

FIGURE 5. LARGE SIGNAL FREQUENCY RESPONSE

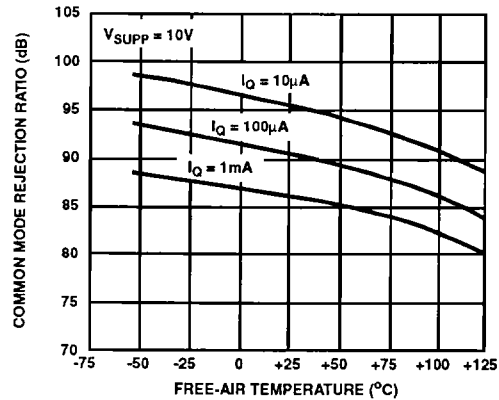

FIGURE 6. COMMON MODE REJECTION RATIO vs FREE-AIR TEMPERATURE

2
OPERATIONAL
AMPLIFIERS

Typical Performance Curves (Continued)

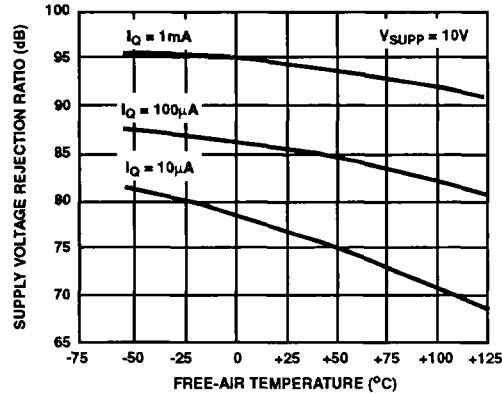

FIGURE 7. POWER SUPPLY REJECTION RATIO vs FREE-AIR TEMPERATURE

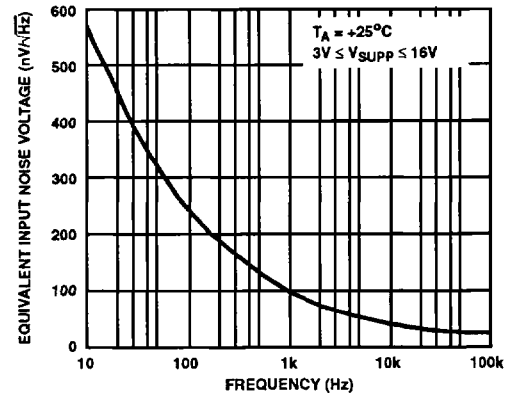

FIGURE 8. EQUIVALENT INPUT NOISE VOLTAGE vs FREQUENCY

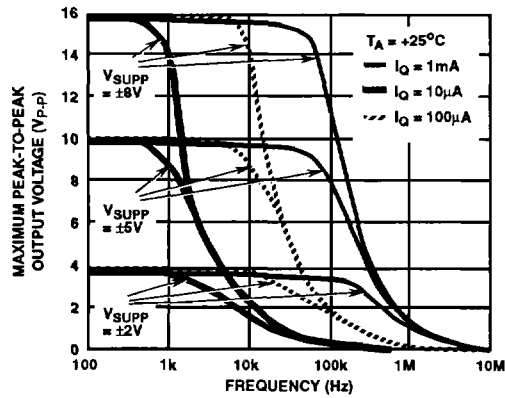

FIGURE 9. OUTPUT VOLTAGE vs FREQUENCY

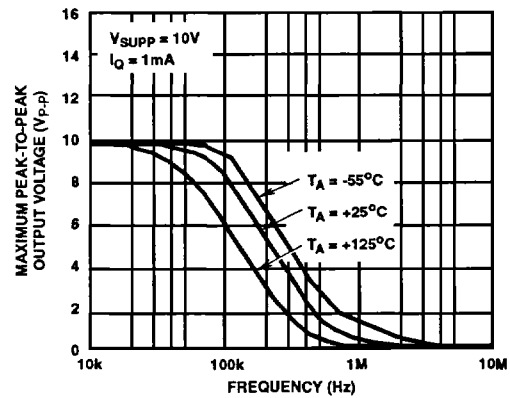

FIGURE 10. OUTPUT VOLTAGE vs FREQUENCY

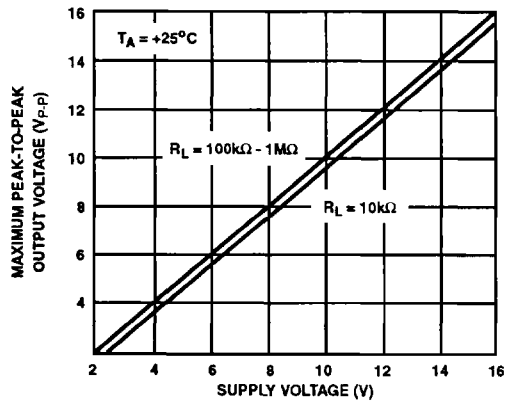

FIGURE 11. OUTPUT VOLTAGE vs SUPPLY VOLTAGE

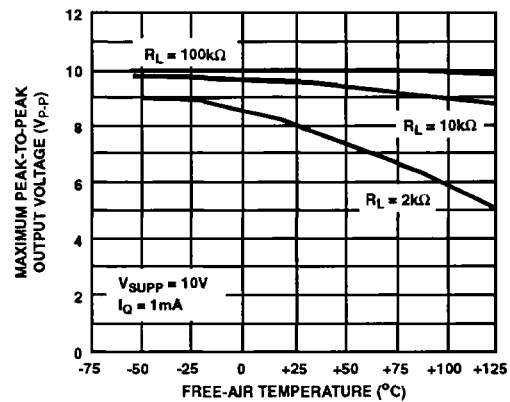

FIGURE 12. OUTPUT VOLTAGE vs FREE-AIR TEMPERATURE

Typical Performance Curves (Continued)

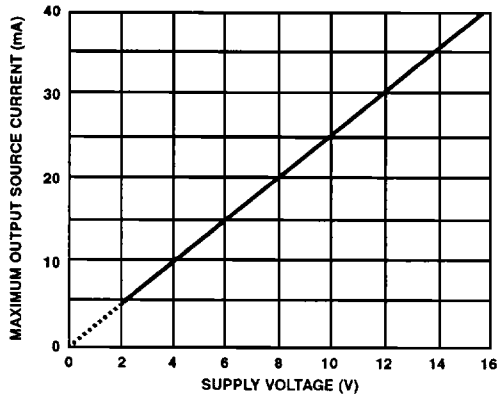

FIGURE 13. OUTPUT SOURCE CURRENT vs SUPPLY VOLTAGE

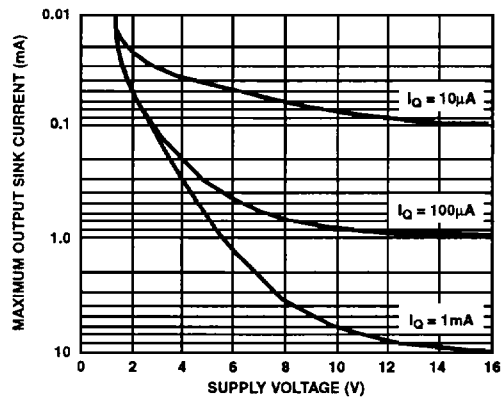

FIGURE 14. OUTPUT SINK CURRENT vs SUPPLY VOLTAGE

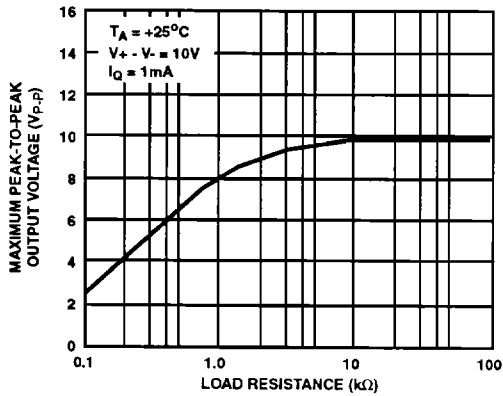

FIGURE 15. OUTPUT VOLTAGE vs LOAD RESISTANCE

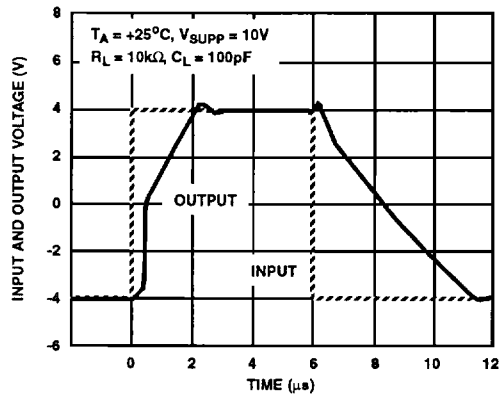

FIGURE 16. VOLTAGE FOLLOWER LARGE SIGNAL PULSE RESPONSE ($I_Q = 1\text{mA}$)

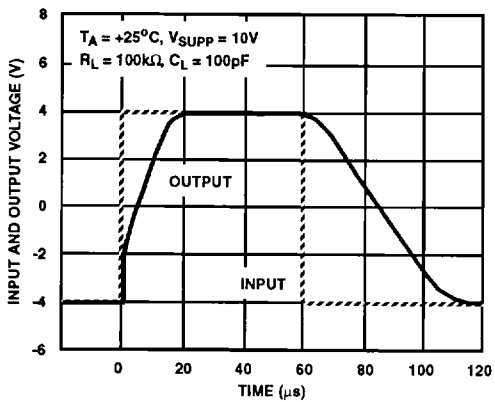

FIGURE 17. VOLTAGE FOLLOWER LARGE SIGNAL PULSE RESPONSE ($I_Q = 100\mu\text{A}$)

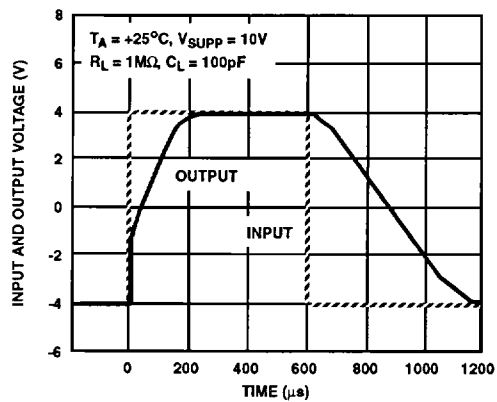

FIGURE 18. VOLTAGE FOLLOWER LARGE SIGNAL PULSE RESPONSE ($I_Q = 10\mu\text{A}$)

Detailed Description

Static Protection

All devices are static protected by the use of input diodes. However, strong static fields should be avoided, as it is possible for the strong fields to cause degraded diode junction characteristics, which may result in increased input leakage currents.

Latchup Avoidance

Junction-isolated CMOS circuits employ configurations which produce a parasitic 4-layer (p-n-p-n) structure. The 4-layer structure has characteristics similar to an SCR, and under certain circumstances may be triggered into a low impedance state resulting in excessive supply current. To avoid this condition, no voltage greater than 0.3V beyond the supply rails may be applied to any pin. In general, the op-amp supplies must be established simultaneously with, or before any input signals are applied. If this is not possible, the drive circuits must limit input current flow to 2mA to prevent latchup.

Choosing the Proper I_Q

Each device in the ICL76XX family has a similar I_Q set-up scheme, which allows the amplifier to be set to nominal quiescent currents of 10 μ A, 100 μ A or 1mA. These current settings change only very slightly over the entire supply voltage range. The ICL7611/12 have an external I_Q control terminal, permitting user selection of each amplifiers' quiescent current. The ICL7621 and ICL7641/7642 have fixed I_Q settings:

ICL7621 (Dual) - $I_Q = 100\mu$ A

ICL7641 (Quad) - $I_Q = 1$ mA

ICL7642 (Quad) - $I_Q = 10\mu$ A

NOTE: The output current available is a function of the quiescent current setting. For maximum p-p output voltage swings into low impedance loads, I_Q of 1mA should be selected.

Output Stage and Load Driving Considerations

Each amplifiers' quiescent current flows primarily in the output stage. This is approximately 70% of the I_Q settings. This allows output swings to almost the supply rails for output loads of 1M Ω , 100k Ω , and 10k Ω , using the output stage in a highly linear class A mode. In this mode, crossover distortion is avoided and the voltage gain is maximized. However, the output stage can also be operated in Class AB for higher output currents. (See graphs under Typical Operating Characteristics). During the transition from Class A to Class B operation, the output transfer characteristic is non-linear and the voltage gain decreases.

Frequency Compensation

The ICL76XX are internally compensated, and are stable for closed loop gains as low as unity with capacitive loads up to 100pF.

Operation At $V_{SUPP} = \pm 1.0V$

Operation at $V_{SUPP} = \pm 1.0V$ is guaranteed for the ICL7642C only.

Output swings to within a few millivolts of the supply rails are achievable for $R_L \geq 1M\Omega$. Guaranteed input CMVR is $\pm 0.6V$ minimum and typically +0.9V to -0.7V at $V_{SUPP} = \pm 1.0V$. For applications where greater common mode range is desirable, refer to the ICL7612 data sheet.

Applications

The user is cautioned that, due to extremely high input impedances, care must be exercised in layout, construction, board cleanliness, and supply filtering to avoid hum and noise pickup.

Note that in no case is I_Q shown. The value of I_Q must be chosen by the designer with regard to frequency response and power dissipation.

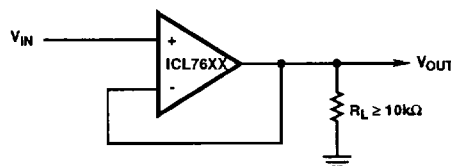

FIGURE 19. SIMPLE FOLLOWER

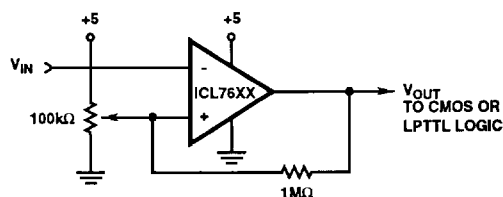
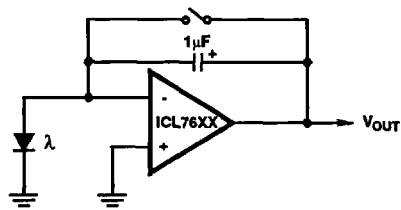

FIGURE 20. LEVEL DETECTOR*

* By using the ICL7612 in this application, the circuit will follow rail to rail inputs.



* Low leakage currents allow integration times up to several hours.

FIGURE 21. PHOTOCURRENT INTEGRATOR

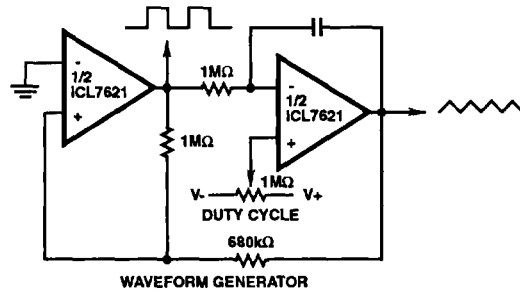

Since the output range swings exactly from rail to rail, frequency and duty cycle are virtually independent of power supply variations.

FIGURE 22. PRECISE TRIANGLE/SQUARE WAVE GENERATOR

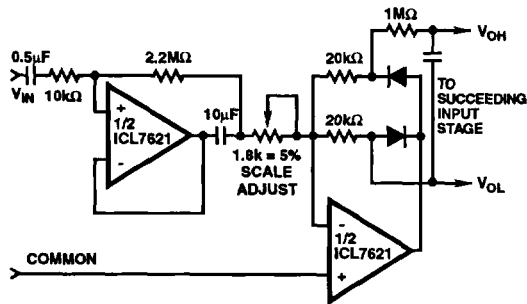

FIGURE 23. AVERAGING AC TO DC CONVERTER FOR A/D CONVERTERS SUCH AS ICL7106, ICL7107, ICL7109, ICL7116, ICL7117

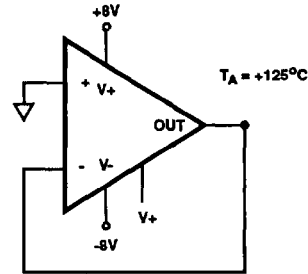
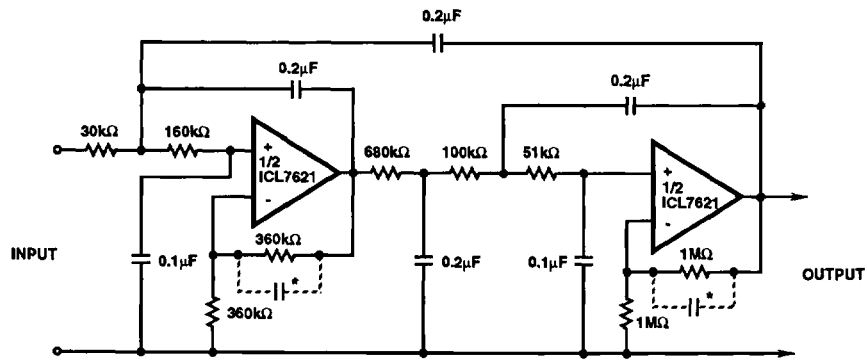

FIGURE 24. BURN-IN AND LIFE TEST CIRCUIT



The low bias currents permit high resistance and low capacitance values to be used to achieve low frequency cutoff. $f_c = 10\text{Hz}$, $A_{VCL} = 4$, Passband ripple = 0.1dB

*Note that small capacitors (25 - 50pF) may be needed for stability in some cases.

FIGURE 26. FIFTH ORDER CHEBYSHEV MULTIPLE FEEDBACK LOW PASS FILTER