

CODING CHART					
BLACK	P/N: 0981980001	BROWN	P/N: 0981980002	GREY	P/N: 0981980003

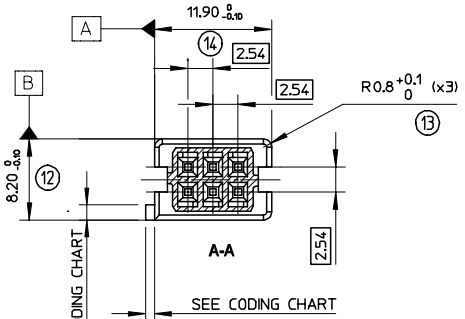
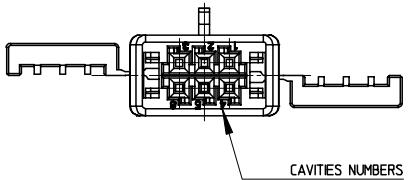
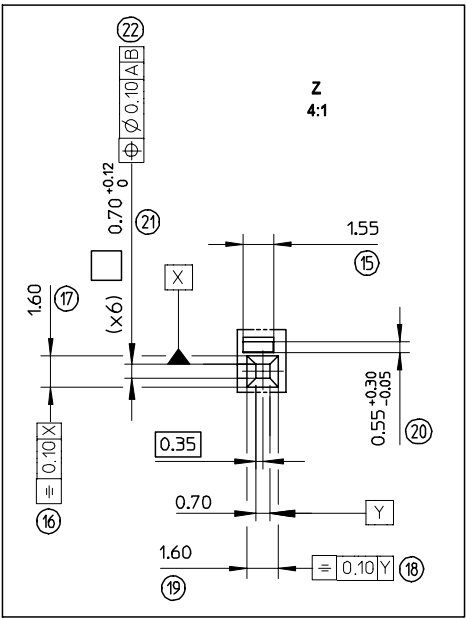
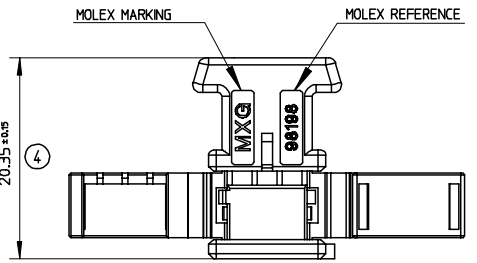
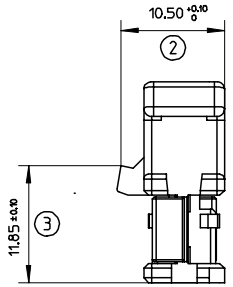
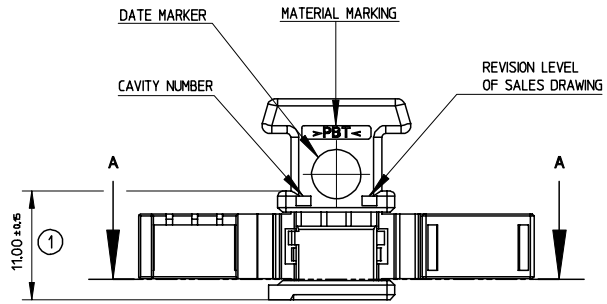
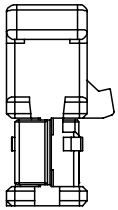

**NOTES:**  
 -Application Specification: AS-98198-001  
 -Material: PBT  
 -Terminals used: 98194

First Release EC NO: G2006-0578 DRWN: GDESBRUERES 2006/06/02 CHKD: MANDRE 2006/06/02 APPR: LSTICKEIR 2006/06/06	GENERAL TOLERANCES (UNLESS SPECIFIED)		DIMENSION STYLE MM ONLY		SCALE 2:1	DESIGN UNITS METRIC	FIRST ANGLE PROJECTION		
	4 PLACES	± ---	± ---	DRAWN BY	DATE	TITLE CONNECTOR 2X3CKT MOX 0.6 FEMALE HOUSING SALES DRAWING			
	3 PLACES	± ---	± ---	CHECKED BY	DATE	MOLEX INCORPORATED			
	2 PLACES	± 0.05	± ---	M. ANDRE	2006/05/12	MATERIAL NO. SEE CHART DOCUMENT NO. SD-98198-003 SHEET NO. 1 OF 1			
1 PLACE	± 0.1	± ---	L. STICKEIR	2006/05/12	DRAFT WHERE APPLICABLE MUST REMAIN WITHIN DIMENSIONS				
ANGULAR ± 2 °		THIS DRAWING CONTAINS INFORMATION THAT IS PROPRIETARY TO MOLEX INCORPORATED AND SHOULD NOT BE USED WITHOUT WRITTEN PERMISSION							