



A Product Line of
Diodes Incorporated



SPECIFICATION FOR APPROVAL

CUSTOMER	_____
NOMINAL FREQUENCY	40.000000 MHz
HOLDER TYPE	TYPE HX 3.2x2.5 SEAM SEALED CRYSTAL CLOCK OSCILLATOR
SPEC. NO. (P/N)	HX31400005
CUSTOMER P/N	_____
ISSUE DATE	May 27, 2019
VERSION	B

APPROVED	PREPARED	QA

Diodes Incorporated

No.2, Ziqiang 5th Rd., Zhongli Industrial Park,
 Zhongli Dist., Taoyuan City 32063, Taiwan (R.O.C.)
 TEL: 886-3-451-8888
 FAX: 886-3-461-3865
<https://www.diodes.com>

- *Pb-free
- *RoHS Compliant
- *HF-Halogen Free
- *REACH Compliant

TYPE HX 3.2x2.5 SEAM SEALED CRYSTAL CLOCK OSCILLATOR

HX31400005

VER. B 27-May-19

ELECTRICAL SPECIFICATIONS

SRe Part Number : HX31400005

Item	Symbol	Specifications	Units	Notes
Nominal Frequency	F ₀	40.000000	MHz	
Frequency Stability	FT	± 20	ppm	**See note
Operating Temperature Range	TR	-40 to +100	°C	
Supply Voltage	V _{DD}	+2.5 ± 5.0%	V	
Logic Type	LT	LVC MOS		
Supply Current, Output Enabled	I _{DD} /OE	20	mA	Max.
Supply Current, Output Disabled	I _{DD} /OD	100	µA	Max.
Duty Cycle (Symmetry)	DC/SY	45 / 55	%	Measured 50% of Waveform
Rise / Fall Time	T _R /T _F	8	ns	Max. measured 20/80% of Waveform
Output Voltage "0" Level	V _{OL}	10% V _{DD}	V	Max at I _{OL} = 4.0mA Min.
Output Voltage "1" Level	V _{OH}	90% V _{DD}	V	Min at I _{OH} = -4.0mA Max.
Output Load	CL	15	pF	Max.
Jitter, Phase	RMS	1	ps	Max. 12KHz ~ 20MHz Frequency Band
Jitter, Accumulated	RMS(1-σ)	4	ps	Max. 20,000 Consecutive Periods
Jitter, Peak to Peak	Pk-Pk	40	ps	Max. 100,000 Random Periods
Start Up Time		10	ms	Max.
Storage Temperature Range		-55 to +125	°C	

※ This product doesn't include harmful substance that stipulated by SONY SS-00259 Level 1 and S-AT2-001 Level 1 standard. RoHS Compliant (Pb - Free).

**Stability includes all combinations of Operating Temperature, Load changes, rated Input (Supply) Voltage changes, Initial Calibration Tolerance (25°C), Aging (1 year at 25°C Average Effective Ambient Temperature), Shock and Vibration.

Output Enable / Disable Function

Parameter	Min.	Typ.	Max.	Units	Notes
Input Voltage (Pin1), Output Enable	0.7V _{DD}			V	Or Open
Input Voltage (Pin1), Output Disable (low power standby)			0.3V _{DD}	V	Output is Hi-Z
Output Disable Delay			150	ns	
Output Enable Delay			150	ns	



TYPE HX 3.2x2.5 SEAM SEALED CRYSTAL CLOCK OSCILLATOR

HX3140005

VER. B 27-May-19

TEST CIRCUIT

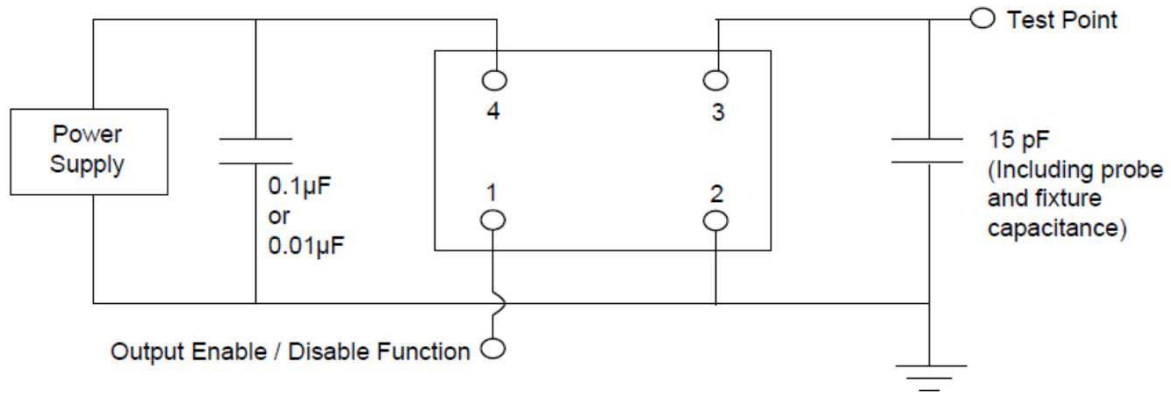

OUTPUT WAVEFORM

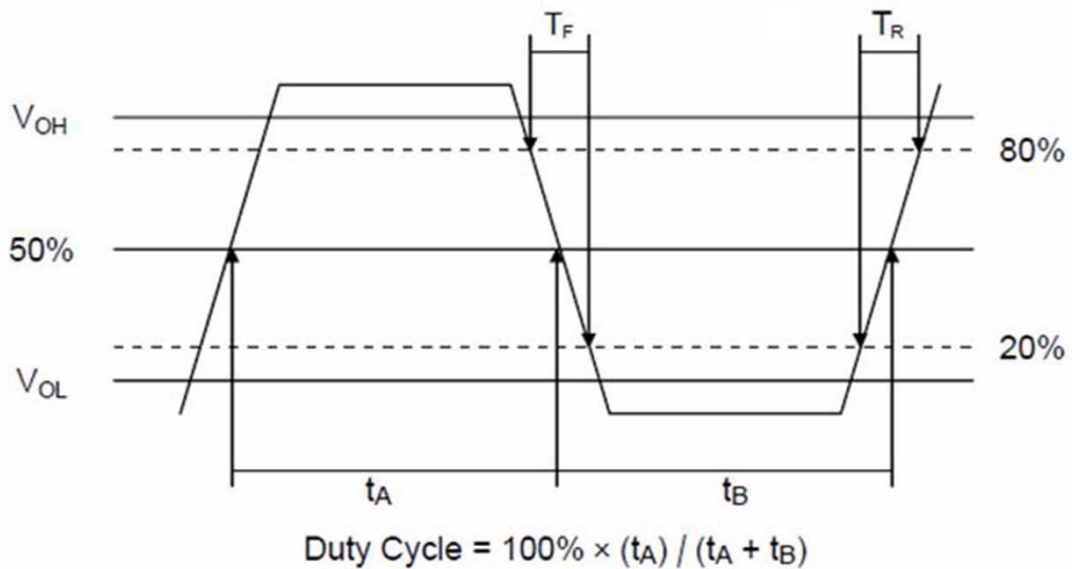

TYPE HX 3.2x2.5 SEAM SEALED CRYSTAL CLOCK OSCILLATOR

HX31400005

VER. B 27-May-19

RELIABILITY SPECIFICATIONS

ENVIRONMENTAL:

- a) THERMAL SHOCK: MIL-STD-883, Method 1011, Condition A
- b) MOISTURE RESISTANCE: MIL-STD-883, Method 1004
- c) VIBRATION: MIL-STD-883, Method 2007, Condition A
- d) RESISTANCE TO SOLDERING HEAT: J-STD-020D Table 5-2 Pb-free devices (except 2 cycles max)
- e) HAZARDOUS SUBSTANCE: Pb - free and RoHS Compliant.

MECHANICAL:

- a) SHOCK: MIL-STD-883, Method 2002, Condition B
- b) SOLDERABILITY: JESD22-B102-D Method 2 (Preconditioning E)
- c) TERMINAL STRENGTH: MIL-STD-883, Method 2004, Test Condition D
- d) GROSS LEAK: MIL-STD-883, Method 1014, Condition C
- e) FINE LEAK: MIL-STD-883, Method 1014, Condition A2, $R1=2 \times 10^{-8}$ atm cc/s
- f) SOLVENT RESISTANCE: MIL-STD-202, Method 215

SUGGESTED IR REFLOW PROFILE

*As per IPC-JEDEC J-STD-020D

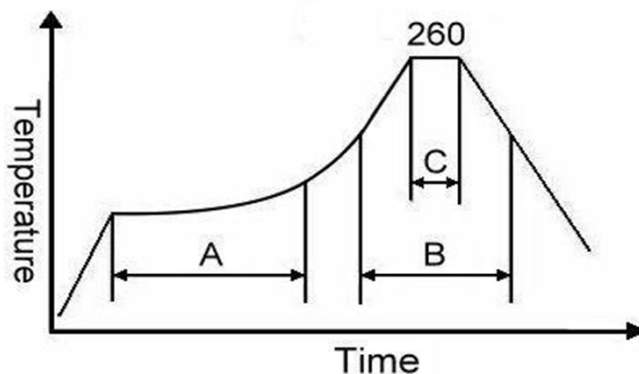

Note:

	Stage	Temperature	Time
A	Preheat	150~200°C	60~120 Sec
B	Primary Heat	217°C	60~150 Sec
C	Peak	260°C	10 Sec

TYPE HX 3.2x2.5 SEAM SEALED CRYSTAL CLOCK OSCILLATOR

HX31400005

VER. B 27-May-19

MARKING

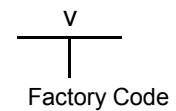
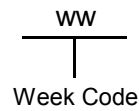
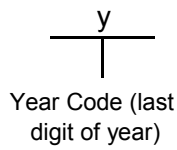
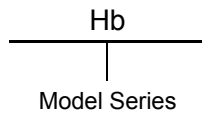
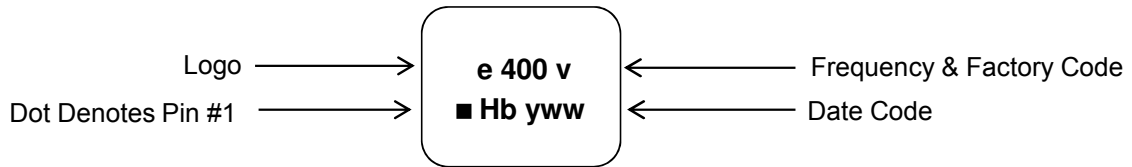

MECHANICAL DRAWINGS (Scale: None. Dimensions are in mm.)

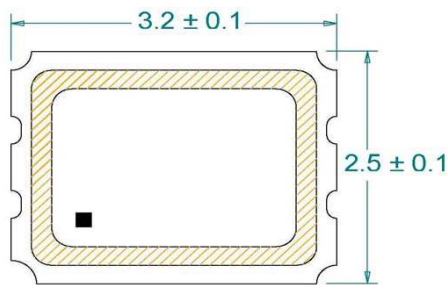

Recommended Land Pattern*

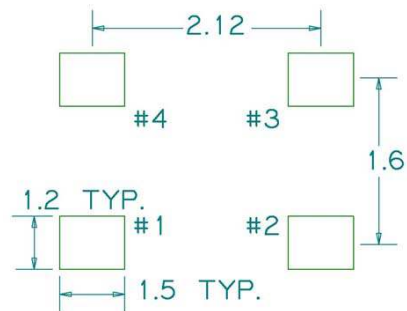

*External high-frequency power decoupling is recommended. (see test circuit for minimum recommendation). To ensure optimal performance, do not route traces beneath the package.

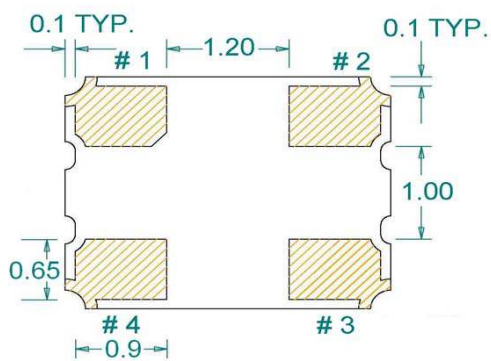

(Bottom View)

Pin	Function
1	OE
2	Ground
3	Clock Output
4	V _{DD}

TYPE HX 3.2x2.5 SEAM SEALED CRYSTAL CLOCK OSCILLATOR

HX31400005

VER. B 27-May-19

TAPE&REEL

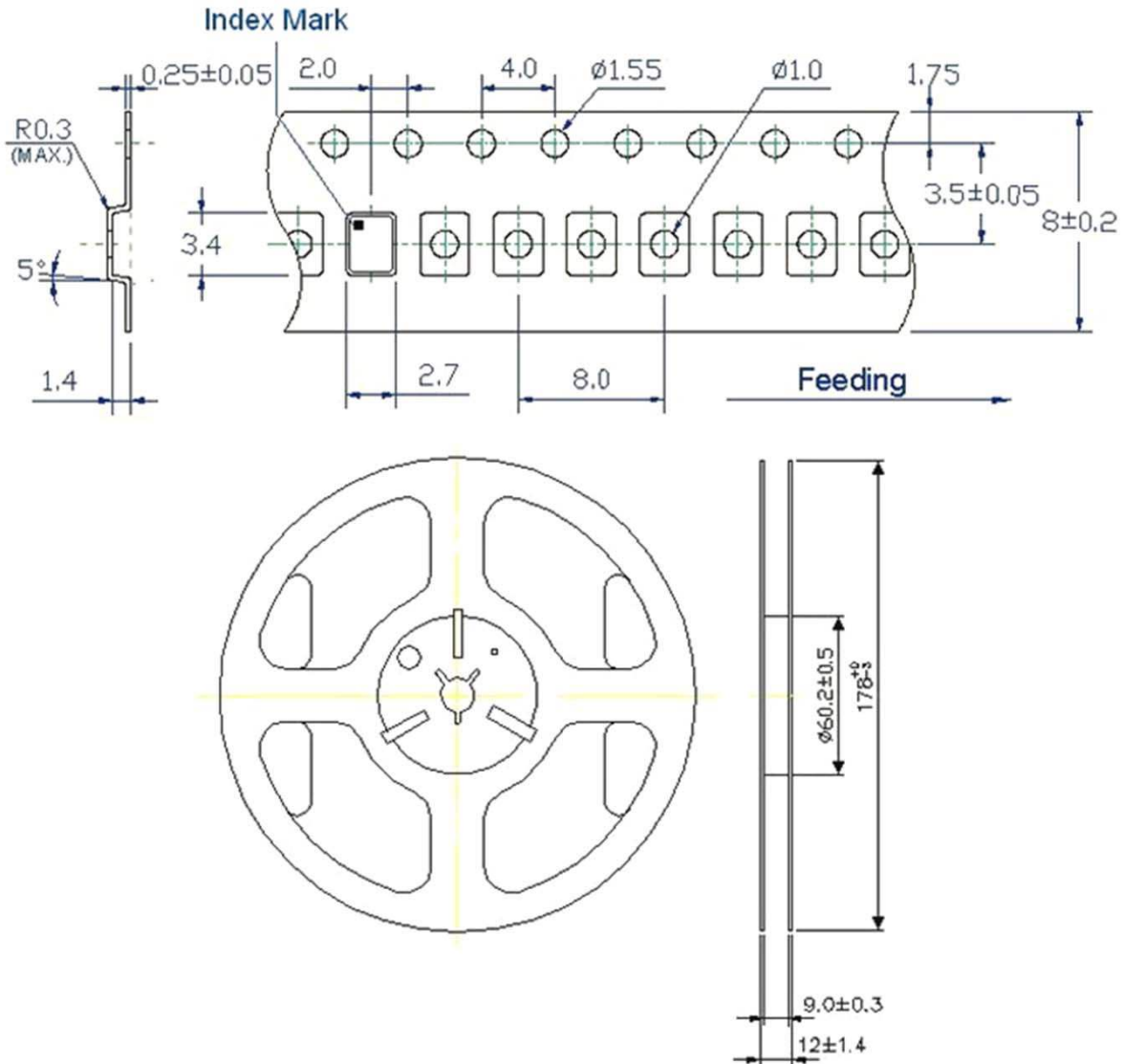

1. 230mm minimum leafer which consist of carrier and/or tape followed by a minimum of 160mm of empty carrier tape sealed with cover tape.
2. 160mm minimum trailer of empty carrier tape sealed with cover tape.

TYPE HX 3.2x2.5 SEAM SEALED CRYSTAL CLOCK OSCILLATOR

HX31400005

VER. B 27-May-19

PACKING

