

ILC7080/81

50/100mA SOT-23 CMOS RF LDO™ Regulators

Features

- Ultra low 1mV dropout per 1mA load
- 1% output voltage accuracy
- Uses low ESR ceramic output capacitor to minimize noise and output ripple
- Only 100 μ A ground current at 100mA load
- Ripple rejection up to 85dB at 1kHz, 60dB at 1MHz
- Less than 80 μ V_{RMS} noise at BW = 100Hz to 100kHz
- Excellent line and load transient response
- Over current / over temperature protection
- Guaranteed up to 80/150mA output current
- Industry standard five lead SOT-23 package
- Fixed 2.5V, 2.6V, 2.7V, 2.8V, 2.85V, 2.9V, 3.0, 3.1V, 3.3V, 3.6V, 4.7V, 5.0V and adjustable output (ILC7081 only) voltage options
- Metal mask option available for custom voltages between 2.5 to 5.1V

Applications

- Cellular phones
- Wireless communicators
- PDAs / palmtops / organizers
- Battery powered portable electronics

Description

The ILC7080/81 are 50 or 100mA low dropout (LDO) voltage regulators designed to provide a high performance solution to low power systems.

The devices offer a typical combination of low dropout and low quiescent current expected of CMOS parts, while uniquely providing the low noise and high ripple rejection characteristics usually only associated with bipolar LDO regulators.

The devices have been optimized to meet the needs of modern wireless communications design; Low noise, low dropout, small size, high peak current, high noise immunity.

The ILC7080/81 are designed to make use of low cost ceramic capacitors while outperforming other devices that require tantalum capacitors.

Typical Applications

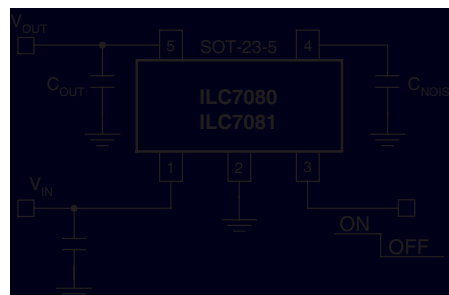

Pin Assignments

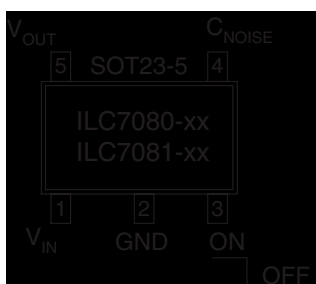

Fixed Voltage Option



Adjustable Voltage Option

Pin Description ILC7080/81-xx (fixed voltage version)

Pin Number	Pin Name	Pin Description
1	V_{IN}	Connect direct to supply
2	GND	Ground pin. Local ground for C_{NOISE} and C_{OUT} .
3	ON/ \overline{OFF}	By applying less than 0.4V to this pin the device will be turned off.
4	C_{NOISE}	Optional noise bypass capacitor may be connected between this pin and GND (pin 2). Do not connect C_{NOISE} directly to the main power ground plane.
5	V_{OUT}	Output Voltage. Connect C_{OUT} between this pin and GND (pin 2).

Pin Description ILC7081-ADJ (adjustable voltage version)

Pin Number	Pin Name	Pin Description
1	V_{IN}	Connect direct to supply
2	GND	Ground pin. Local ground for C_{NOISE} and C_{OUT} .
3	ON/ \overline{OFF}	By applying less than 0.4V to this pin the device will be turned off.
4	V_{ADJ}	Voltage feedback pin to set the adjustable output voltage. Do not connect a capacitor to this pin.
5	V_{OUT}	Output Voltage. Connect C_{OUT} between this pin and GND (pin 2).

Absolute Maximum Ratings (Note 1)

Parameter	Symbol	Ratings	Units
Input voltage	V_{IN}	-0.3 to +13.5	V
On/Off Input voltage	$V_{ON/OFF}$	-0.3 to V_{IN}	
Output Current	I_{OUT}	Short circuit protected	mA
Output voltage	V_{OUT}	-0.3 to $V_{IN}+0.3$	V
Package Power Dissipation (SOT-23-5)	P_D	250 (Internally Limited)	mW
Maximum Junction Temp Range	$T_{J(max)}$	-40 to +150	$^{\circ}C$
Storage Temperature	T_{STG}	-40 to +125	$^{\circ}C$
Operating Ambient Temperature	T_A	-40 to +85	$^{\circ}C$
Package Thermal Resistance	θ_{JA}	333	$^{\circ}C/W$

Recommended Operating Conditions

Parameter	Min.	Typ.	Max.	Units
Input Voltage	$V_{OUT}+V_{DO}$	$V_{OUT}+1$	13	V
Operating Ambient Temperature	-40		+85	$^{\circ}C$

Electrical Characteristics ILC7080/81AIM5

Unless otherwise specified, all limits are at $T_A=25^\circ\text{C}$; $V_{IN} = V_{OUT(NOM)} + 1\text{V}$, $I_{OUT} = 1\text{mA}$, $C_{OUT} = 1\mu\text{F}$, $V_{ON/OFF} = 2\text{V}$.
 Boldface type denotes specifications which apply over the specified operating temperature range.

Parameter	Symbol	Conditions		Min.	Typ.	Max.	Units
Input voltage Range	V_{IN}			2		13	V
Output voltage	V_{OUT}	$I_{OUT} = 1\text{mA}$ $1\text{mA} \leq I_{OUT} \leq 100\text{mA}$ $1\text{mA} \leq I_{OUT} \leq 100\text{mA}$		-1 -1.5 -3.5	$V_{OUT(NOM)}$	+1 1.5 +3.5	%
Feedback Voltage (ADJ version)	V_{ADJ}			1.215 1.202	1.240	1.265 1.278	V
Line Regulation	$\frac{\Delta V_{OUT}}{(V_{OUT} \cdot \Delta V_{IN})}$	$V_{OUT(NOM)} + 1\text{V} \leq V_{IN} \leq 12\text{V}$			0.007	0.014 0.032	%/V
Dropout voltage (Note 3)	$V_{IN} - V_{OUT}$	7080/81	$I_{OUT} = 0\text{mA}$ (Note 4)		0.1	1 2	mV
			$I_{OUT} = 10\text{mA}$		10	25 35	
		7080 only	$I_{OUT} = 50\text{mA}$		110	125 150	
			7081 only	$I_{OUT} = 50\text{mA}$		50	
				$I_{OUT} = 100\text{mA}$		100	
			$I_{OUT} = 150\text{mA}$		150	225 300	
Ground Pin Current	I_{GND}	7080/81	$I_{OUT} = 0\text{mA}$		95	200 220	μA
			$I_{OUT} = 10\text{mA}$		100	220 240	
			$I_{OUT} = 50\text{mA}$		100	220 240	
		7081 only	$I_{OUT} = 100\text{mA}$		100	240 260	
			$I_{OUT} = 150\text{mA}$		115	260 280	
Shutdown (OFF) Current	$I_{ON/OFF}$	$V_{ON/OFF} = 0\text{V}$			0.1	2	μA
ON/OFF Input Voltage	$V_{ON/OFF}$	High = Regulator On Low = Regulator Off		2.0		0.6	V
ON/OFF Pin Input Current	$I_{IN(ON/OFF)}$	$V_{ON/OFF} = 0.6\text{V}$, regulator OFF $V_{ON/OFF} = 2\text{V}$, regulator ON			0.3 1		μA
Peak Output Current (Note 4)	$I_{OUT(peak)}$	$V_{OUT} \geq 0.95V_{OUT(NOM)}$, $t_{pw}=2\text{ms}$		400	500		mA
Output Noise Voltage (RMS)	e_N	BW=300Hz to 50kHz, $C_{NOISE}=0.01\mu\text{F}$			80		μV_{RMS}
Ripple Rejection	$\Delta V_{OUT}/\Delta V_{IN}$	$C_{OUT} = 4.7\mu\text{F}$, $I_{OUT} = 100\text{mA}$	Freq. = 1kHz		85		dB
			Freq. = 10kHz		70		
			Freq. = 1MHz		60		
Dynamic Line Regulation	$\Delta V_{OUT(line)}$	$V_{IN}: V_{OUT(NOM)}+1\text{V}$ to $V_{OUT(NOM)}+2\text{V}$, $t_r/t_f = 2\mu\text{s}$; $I_{OUT} = 100\text{mA}$			4		mV
Dynamic Load Regulation	$\Delta V_{OUT(load)}$	$I_{OUT}: 0$ to 100mA ; $d(I_{OUT})/dt = 100\text{mA}/\mu\text{s}$ with $C_{OUT} = 0.47\mu\text{F}$ with $C_{OUT} = 2.2\mu\text{F}$			50		mV
					25		
Short Circuit Current	I_{SC}	$V_{OUT} = 0\text{V}$			600		mA

Notes:

1. Absolute maximum ratings indicate limits which when exceeded may result in damage to the component. Electrical specifications do not apply when operating the device outside of its rated operating conditions.
2. Specified Min/Max limits are production tested or guaranteed through correlation based on statistical control methods. Measurements are taken at constant junction temperature as close to ambient as possible using low duty pulse testing.
3. Dropout voltage is defined as the input to output differential voltage at which the output voltage drops 2% below the nominal value measured with a 1V differential.
4. Guaranteed by design.

Operations

The ILC7080/81 LDO design is based on an advanced circuit configuration for which patent protection has been applied. Typically it is very difficult to drive a capacitive output with an amplifier. The output capacitance produces a pole in the feedback path, which upsets the carefully tailored dominant pole of the internal amplifier. Traditionally the pole of the output capacitor has been “eliminated” by reducing the output impedance of the regulator such that the pole of the output capacitor is moved well beyond the gain bandwidth product of the regulator. In practice, this is difficult to do and still maintain high frequency operation. Typically the output impedance of the regulator is not simply resistive, such that the reactive output impedance interacts with the reactive impedance of the load resistance and capacitance. In addition, it is necessary to place the dominant pole of the circuit at a sufficiently low frequency such that the gain of the regulator has fallen below unity before any of the complex interactions between the output and the load occur. The ILC7080/81 does not try to eliminate the output pole, but incorporates it into the stability scheme. The load and output capacitor forms a pole, which rolls off the gain of the regulator below unity. In order to do this the output impedance of the regulator must be high, looking like a current source. The output stage of the regulator becomes a transconductance amplifier, which converts a voltage to a current with a substantial output impedance. The circuit which drives the transconductance amplifier is the error amplifier, which compares the regulator output to the band gap reference and produces an error voltage as the input to the transconductance amplifier. The error amplifier has a dominant pole at low frequency and a “zero” which cancels out the effects of the pole. The zero allows the regulator to have gain out to the frequency where the output pole continues to reduce the gain to unity. The configuration of the poles and zero are shown in figure 1.

Instead of powering the critical circuits from the unregulated input voltage, the CMOS RF LDO powers the internal circuits such as the bandgap, the error amplifier and most of the transconductance amplifier from the boot strapped regulated output voltage of the regulator. This technique offers extremely high ripple rejection and excellent line transient response.

A block diagram of the regulator circuit used in the ILC7080/81 is shown in figure 2, which shows the input-to-output isolation and the cascaded sequence of amplifiers that implement the pole-zero scheme outlined above.

The ILC7080/81 were designed in a CMOS process with some minor additions, which allow the circuit to be used at input voltages up to 13V. The resulting circuit exceeds the frequency response of traditional bipolar circuits. The ILC7080/81 is very tolerant of output load conditions with the inclusion of both short circuit and thermal overload protection. The device has a very low dropout voltage, typically a linear response of 1mV per milliamp of load current, and none of the quasi-saturation characteristics of a bipolar output device. All the good features of the frequency response and regulation are valid right to the point where the regulator goes out of regulation in a 4mV transition region. Because there is no base drive, the regulator is capable of providing high current surges while remaining in regulation. This is shown in the high peak current of 500mA which allows for the ILC7080/81 to be used in systems that require short burst mode operation.

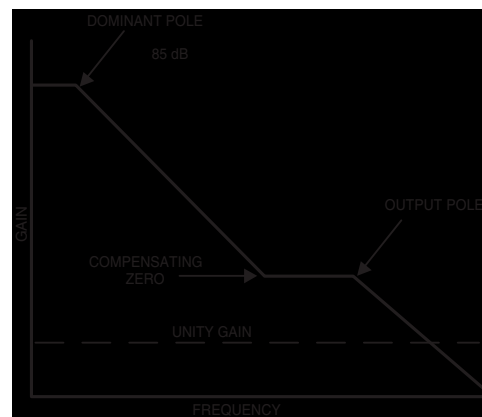

Figure 1. LC7080/81 RF LDO frequency response

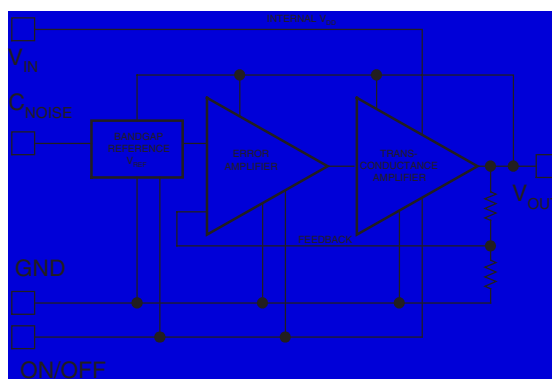

Figure 2. ILC7080/81 RF LDO regulator block diagram

Shutdown (ON/OFF) Operation

The ILC7080/81 output can be turned off by applying 0.4V or less to the device's ON/OFF pin (pin 3). In shutdown mode, the ILC7080/81 draws less than 1μA quiescent current. The output of the ILC7081 is enabled by applying 2V to 13V at the ON/OFF pin. In applications where the ILC7080/81 output will always remain enabled, the ON/OFF pin may be connected to VIN (pin 1). The ILC7080/81's shutdown circuitry includes hysteresis, as such the device will operate properly even if a slow moving signal is applied to the ON/OFF pin.

Short Circuit Protection

The ILC7080/81 output can withstand momentary short circuit to ground. Moreover, the regulator can deliver very high output peak current due to its 1A instantaneous short circuit current capability.

Thermal Protection

The ILC7080/81 also includes a thermal protection circuit which shuts down the regulator when die temperature exceeds 150°C due to overheating. In thermal shutdown, once the die temperature cools to below 140°C, the regulator is enabled. If the die temperature is excessive due to high package power dissipation, the regulator's thermal circuit will continue to pulse the regulator on and off. This is called thermal cycling.

Excessively high die temperature may occur due to high differential voltage across the regulator or high load current or high ambient temperature or a combination of all three. Thermal protection protects the regulator from such fault conditions and is a necessary requirement in today's designs. In normal operation, the die temperature should be limited to under 150°C.

Adjustable Output Voltage

Figure 3 shows how an adjustable output voltage can be easily achieved using ILC7081-ADJ. The output voltage, VOUT is given by the following equation:

$$V_{OUT} = 1.24V \times (R1/R2 + 1)$$

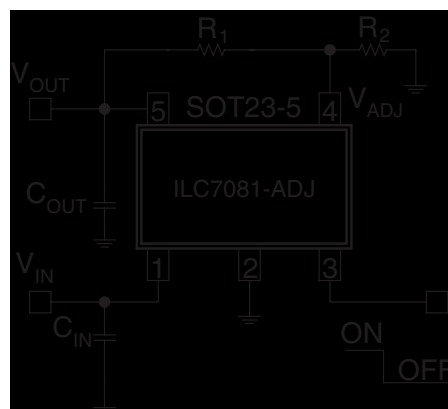

Figure 3. Application circuit for adjustable output voltage

For best results, a resistor value of 470kΩ or less may be used for R2. The output voltage can be programmed from 2.5V to 12V.

Note: An external capacitor should not be connected to the adjustable feedback pin (pin 4). Connecting an external capacitor to pin 4 may cause regulator instability and lead to oscillations.

Maximum Output Current

The maximum output current available from the ILC7080/81 is limited by the maximum package power dissipation as well as the device's internal current limit. For a given ambient temperature, T_A , the maximum package power dissipation is given by:

$$P_{D(max)} = (T_{J(max)} - T_A) / \theta_{JA}$$

where $T_{J(max)} = 150^\circ\text{C}$ is the maximum junction temperature and $\theta_{JA} = 333^\circ\text{C/W}$ is the package thermal resistance. For example at $T_A = 85^\circ\text{C}$ ambient temperature, the maximum package power dissipation is;

$$P_{D(max)} = 195\text{mW}$$

The maximum output current can be calculated from the following equation:

$$I_{OUT(max)} < P_{D(max)} / (V_{IN} - V_{OUT})$$

For example at $V_{IN} = 6\text{V}$, $V_{OUT} = 5\text{V}$ and $T_A = 85^\circ\text{C}$, the maximum output current is $I_{OUT(max)} < 195\text{mA}$. At higher output current, the die temperature will rise and cause the thermal protection circuit to be enabled.

Application Hints

Figure 4 shows the typical application circuit for the ILC7080/81.

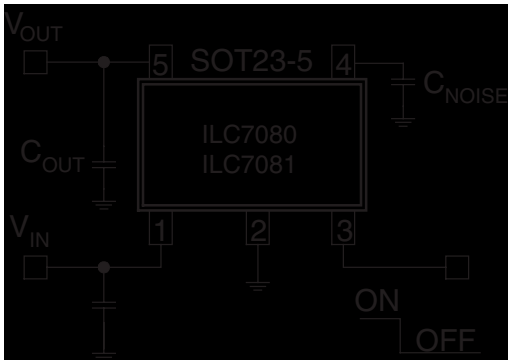

Figure 4. Basic application circuit for fixed output voltage

Input Capacitor

An input capacitor C_{IN} of value $1\mu\text{F}$ or larger should be connected from V_{IN} to the main ground plane. This will help to filter supply noise from entering the LDO. The input capacitor should be connected as close to the LDO regulator input pin as is practical. Using a high-value input capacitor will offer superior line transient response as well as better power supply ripple rejection. A ceramic or tantalum capacitor may be used at the input of the LDO regulator.

Note that there is a parasitic diode from the LDO regulator output to the input. If the input voltage swings below the regulator's

output voltage by a couple of hundred millivolts then the regulator may be damaged. This condition must be avoided. In many applications a large value input capacitor, C_{IN} , will hold V_{IN} higher than V_{OUT} and decay slower than V_{OUT} when the LDO is powered off.

Output Capacitor Selection

Fairchild strongly recommends the use of low ESR (equivalent series resistance) ceramic capacitors for C_{OUT} and C_{NOISE} . The ILC7080/81 is stable with low ESR capacitor (as low as zero Ω). The value of the output capacitor should be $1\mu\text{F}$ or higher. Either ceramic chip or a tantalum capacitor may be used at the output.

Use of ceramic chip capacitors offer significant advantages over tantalum capacitors. A ceramic capacitor is typically considerably cheaper than a tantalum capacitor, it usually has a smaller footprint, lower height, and lighter weight than a tantalum capacitor. Furthermore, unlike tantalum capacitors which are polarized and can be damaged if connected incorrectly, ceramic capacitors are non-polarized. Low value ceramic chip capacitors with X7R dielectric are available in the 100pF to $4.7\mu\text{F}$ range, while high value capacitors with Y5V dielectric are available in the 2200pF to $22\mu\text{F}$ range. Evaluate carefully before using capacitors with Y5V dielectric because their ESR increases significantly at cold temperatures. Figure 10 shows a list of recommended ceramic capacitors for use at the output of ILC7080/81.

Note: If a tantalum output capacitor is used then for stable operation we recommend a low ESR tantalum capacitor with maximum rated ESR at or below 0.4Ω . Low ESR tantalum capacitors, such as the TPS series from AVX Corporation (www.avxcorp.com) or the T495 series from Kemet (www.kemet.com) may be used.

In applications where a high output surge current can be expected, use a high value but low ESR output capacitor for superior load transient response. The ILC7080/81 is stable with no load.

Noise Bypass Capacitor

In low noise applications, the self noise of the ILC7080/81 can be decreased further by connecting a capacitor from the noise bypass pin (pin 4) to ground (pin 2). The noise bypass pin is a high impedance node as such, care should be taken in printed circuit board layout to avoid noise pick-up from external sources. Moreover, the noise bypass capacitor should have low leakage.

Noise bypass capacitors with a value as low as 470pF may be used. However, for optimum performance, use a $0.01\mu\text{F}$ or larger, ceramic chip capacitor. Note that the turn on and turn off response of the ILC7080/81 is inversely proportional to the value of the noise bypass capacitor. For fast turn on and turn off, use a small value noise bypass capacitor. In applications where exceptionally low output noise is not required, consider omitting the noise bypass capacitor altogether.

The Effects of ESR (Equivalent Series Resistance)

The ESR of a capacitor is a measure of the resistance due to the leads and the internal connections of the component. Typically measured in mΩ (milli-ohms) it can increase to ohms in some cases.

Wherever there is a combination of resistance and current, voltages will be present. The control functions of LDOs use two voltages in order to maintain the output precisely; V_{OUT} and V_{REF} .

With reference to the block diagram in figure 2, V_{OUT} is fed back to the error amplifier and is used as the supply voltage for the internal components of the 7080/81. So any change in V_{OUT} will cause the error amplifier to try to compensate to maintain V_{OUT} at the set level and noise on V_{OUT} will be reflected into the supply of each internal circuit. The reference voltage, V_{REF} is influenced by the C_{NOISE} pin. Noise into this pin will add to the reference voltage and be fed through the circuit. These factors will not cause a problem if some simple steps are taken. Figure 5 shows where these added ESR resistances are present in the typical LDO circuit.

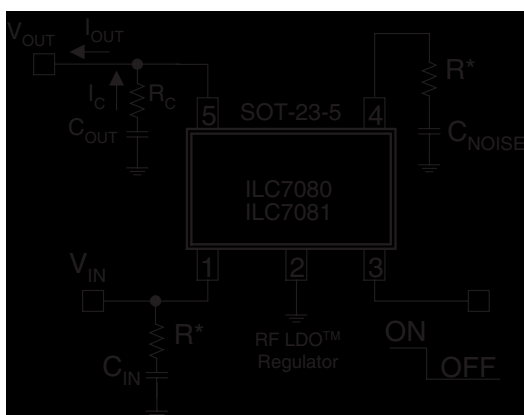

Figure 5. ESR in C_{OUT} and C_{NOISE}

With this in mind low ESR components will offer better performance as LDOs may be exposed to large transients of output voltage, and current flows through the capacitors in order to filter these transient swings. ESR is less of a problem with C_{IN} as the voltage fluctuations at the input will be filtered by the LDO.

However, being aware of these current flows, there is also another potential source of induced voltage noise from the resistance inherent in the PCB trace. Figure 6 shows where the additive resistance of the PCB can manifest itself. Again these resistances may be very small, but a summation of several currents can develop detectable voltage ripple and will be amplified by the LDO. Particularly the accumulation of current flows in the ground plane can develop significant voltages unless care is taken.

With a degree of care, the ILC7080/81 will yield outstanding performance.

Printed Circuit Board Layout Guidelines

As was mentioned in the previous section, to take full advantage of any high performance LDO regulator requires paying careful attention to grounding and printed circuit board (PCB) layout.

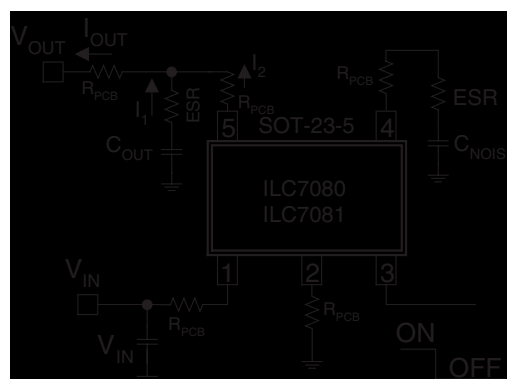

Figure 6. Inherent PCB resistance

Figure 7 shows the effects of poor grounding and PCB layout caused by the ESR and PCB resistances and the accumulation of current flows.

Note particularly that during high output load current, the LDO regulator's ground pin and the ground return for C_{OUT} and C_{NOISE} are not at the same potential as the system ground. This is due to high frequency impedance caused by PCB's trace inductance and DC resistance. The current loop between C_{OUT} , C_{NOISE} and the LDO regulator's ground pin will degrade performance of the LDO.

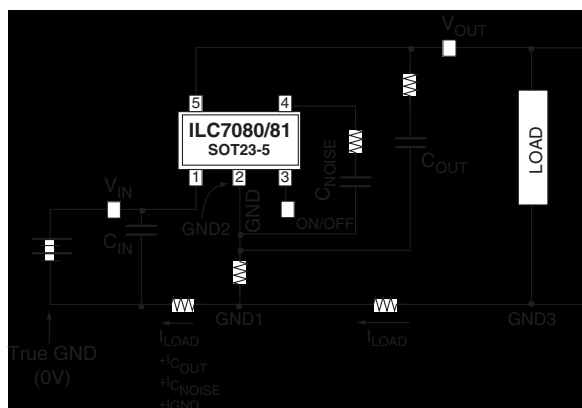

Figure 7. Effects of poor circuit layout

Figure 8 shows an optimum schematic. In this schematic, high output surge current has little effect on the ground current and noise bypass current return of the LDO regulator. Note that the key difference here is that C_{OUT} and C_{NOISE} are directly connected to the LDO regulator's ground pin. The LDO is then separately connected to the main ground plane and returned to a single point system ground.

The layout of the LDO and its external components are also based on some simple rules to minimize EMI and output voltage ripple.

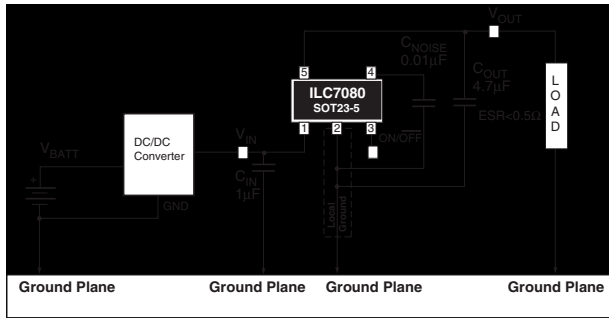

Figure 8. Recommended application circuit schematic

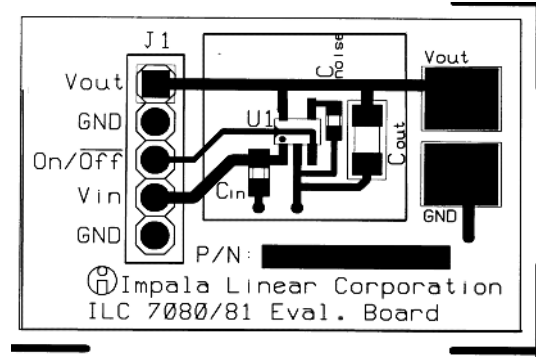

Figure 9. Recommended application circuit layout (not drawn to scale).

Note: ground plane is bottom layer of PCB and connects to top layer ground connections through vias.

Evaluation Board Parts List For Printed Circuit Board Shown Above

Label	Part Number	Manufacturer	Description
U1	ILC7081AIM5-30	Fairchild Semi.	100mA RF LDO™ regulator
J1	69190-405	Berg	Connector, four position header
CIN	GRM40 Y5V 105Z16	muRata	Ceramic capacitor, 1µF,16V, SMT (size 0805)
CNOISE	ECU-V1H103KBV	Panasonic	Ceramic capacitor, 0.01µF,16V, SMT (size 0603)
COUT	GRM42-6X5R475K10	muRata	Ceramic capacitor, 4.7µF,16V, SMT (size 1206)

Grounding Recommendations

1. Connect C_{IN} between V_{IN} of the ILC7080/81 and the “GROUND PLANE”.
2. Keep the ground side of C_{OUT} and C_{NOISE} connected to the “LOCAL GROUND” and not directly to the “GROUND PLANE”.
3. On multilayer boards use component side copper for grounding around the ILC7080/81 and connect back to a “GROUND PLANE” using vias.
4. If using a DC-DC converter in your design, use a star grounding system with separate traces for the power ground and the control signals. The star should radiate from where the power supply enters the PCB.

Layout Considerations

1. Place all RF LDO related components; ILC7080/81, input capacitor C_{IN}, noise bypass capacitor C_{NOISE} and output capacitor C_{OUT} as close together as possible.
2. Keep the output capacitor C_{OUT} as close to the ILC7080/81 as possible with very short traces to the V_{OUT} and GND pins.
3. The traces for the related components; ILC7080/81, input capacitor C_{IN}, noise bypass capacitor C_{NOISE} and output capacitor C_{OUT} can be run with minimum trace widths close to the LDO.
4. Maintain a separate “LOCAL GROUND” remote from the “GROUND PLANE” to ensure a quiet ground near the LDO.

Figure 9 shows how this circuit can be translated into a PCB layout.

Recommended Ceramic Output Capacitors

C_{OUT}	Capacitor Size	I_{OUT}	Dielectric	Part Number	Capacitor Vendor
1 μ F	0805	0 to 100mA	X5R	C2012X5R1A105KT	TDK
"	0805	"	X7R	GRM40X7R105K010	muRata
"	0805	"	X7R	LMK212BJ105KG	Taiyo-Yuden
"	1206	"	X7R	GRM42-6X7R105K016	muRata
"	1206	"	X7R	EMK316BJ105KL	Taiyo-Yuden
"	1206	"	X5R	TMK316BJ105KL	Taiyo-Yuden
2.2 μ F	0805	0 to 150mA	X5R	GRM40X5R225K 6.3	muRata
"	0805	"	X5R	C2012X5R0J225KT	TDK
"	1206	"	X5R	EMK316BJ225ML	Taiyo-Yuden
4.7 μ F	1206	0 to 150mA	X5R	GRM42-6X5R475K010	muRata
"	1206	"	X7R	LMK316BJ475ML	Taiyo-Yuden

Typical Performance Characteristics

Unless otherwise specified $T_A = 25^\circ\text{C}$, $V_{IN} = V_{OUT(NOM)} + 1\text{V}$, ON/OFF pin tied to V_{IN} .
 Characterization at output currents above 50mA applies to ILC7081.

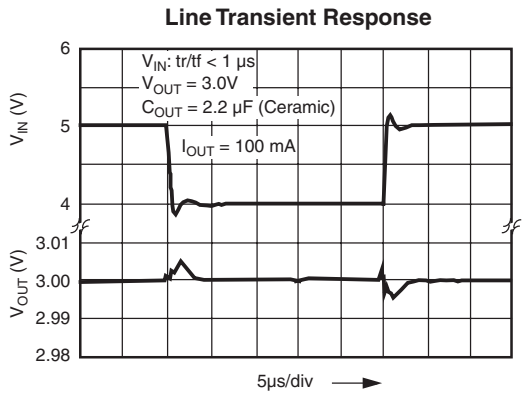
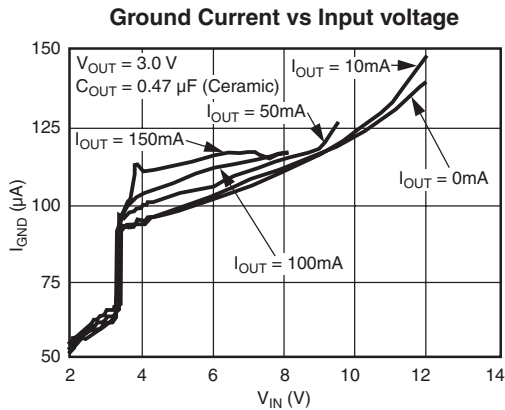
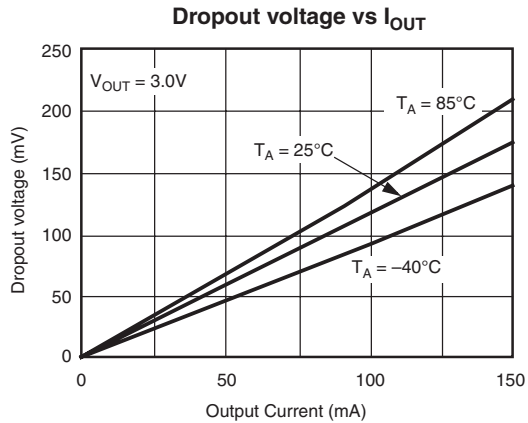
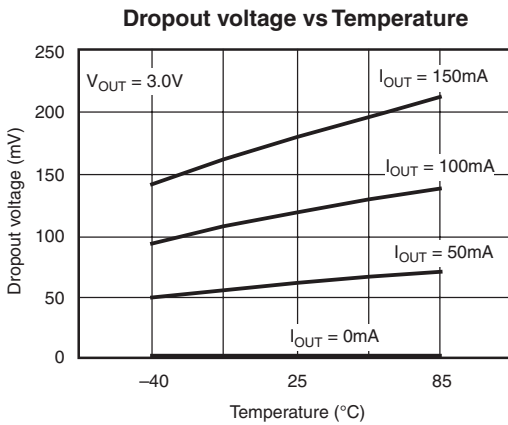
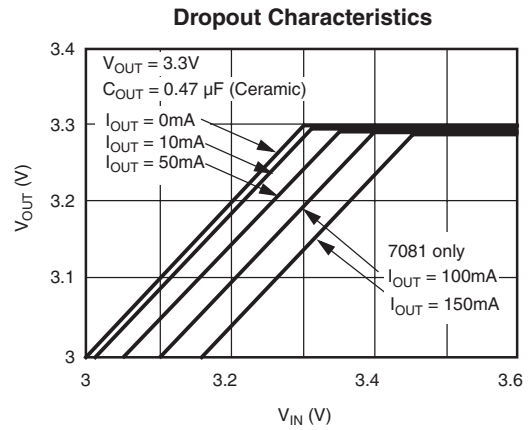
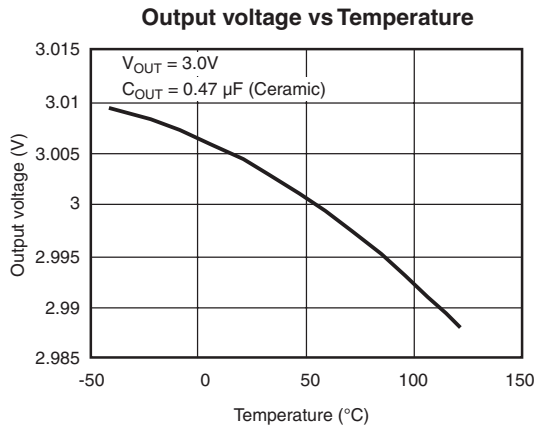

Typical Performance Characteristics

Unless otherwise specified $T_A = 25^\circ\text{C}$, $V_{IN} = V_{OUT(NOM)} + 1\text{V}$, ON/OFF pin tied to V_{IN} .
 Characterization at output currents above 50mA applies to ILC7081.

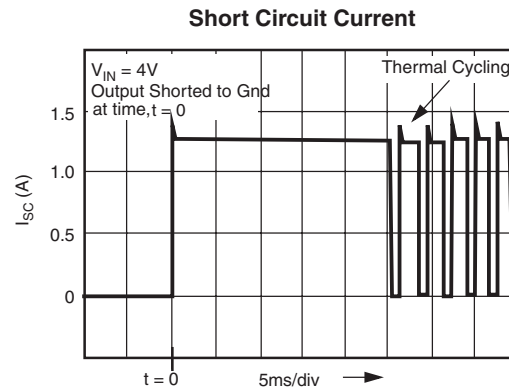
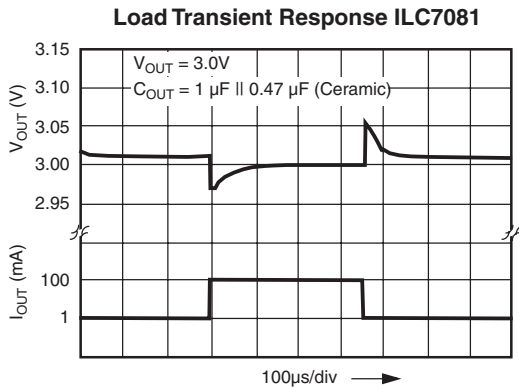
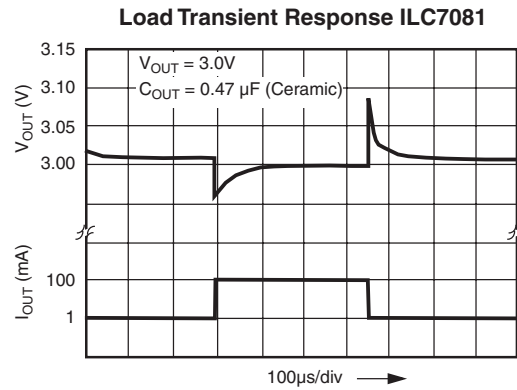
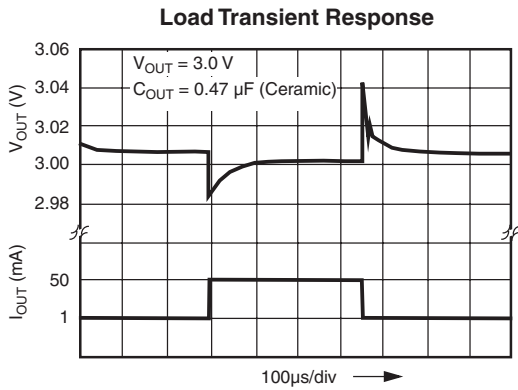
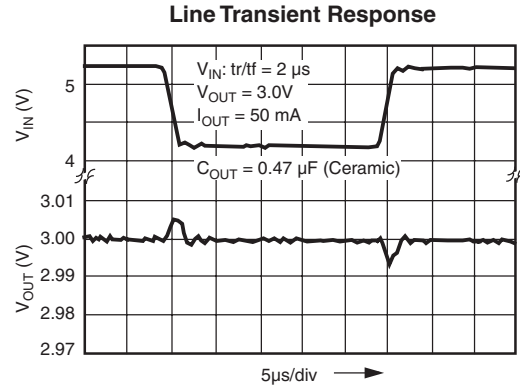
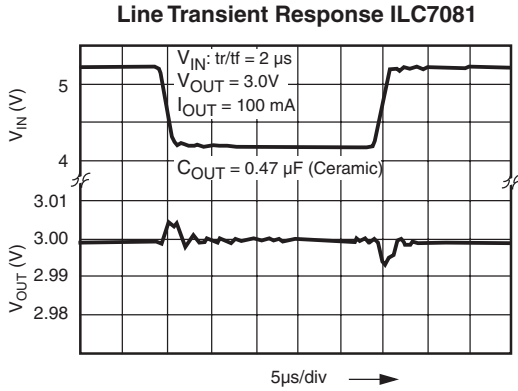

Typical Performance Characteristics

Unless otherwise specified $T_A = 25^\circ\text{C}$, $V_{IN} = V_{OUT(NOM)} + 1\text{V}$, ON/OFF pin tied to V_{IN} .
 Characterization at output currents above 50mA applies to ILC7081.

On/Off Transient Response

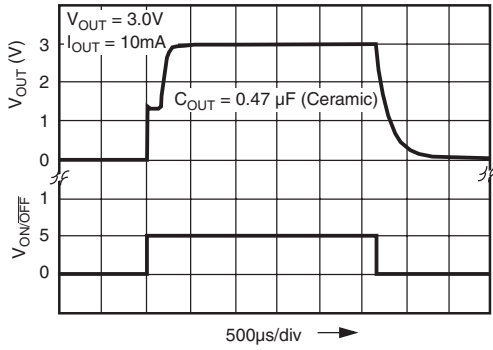

On/Off Transient Response

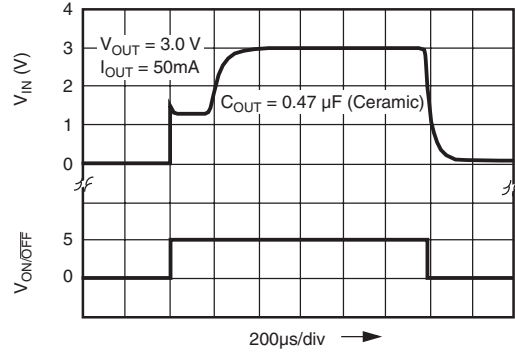

On/Off Transient Response ILC7081

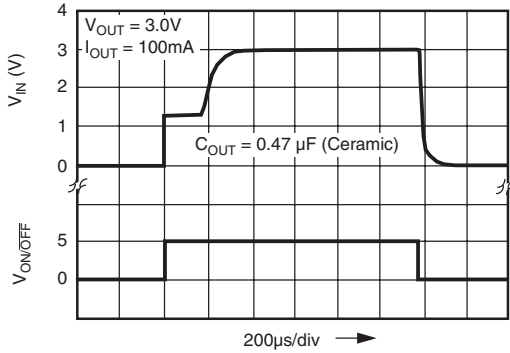

Spectral Noise Density

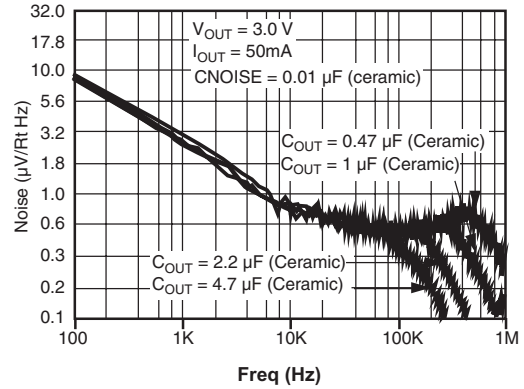

Spectral Noise Density

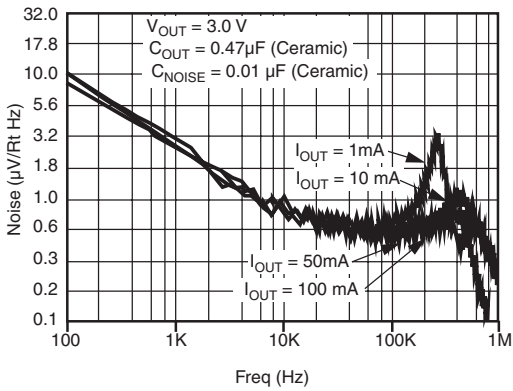

Spectral Noise Density

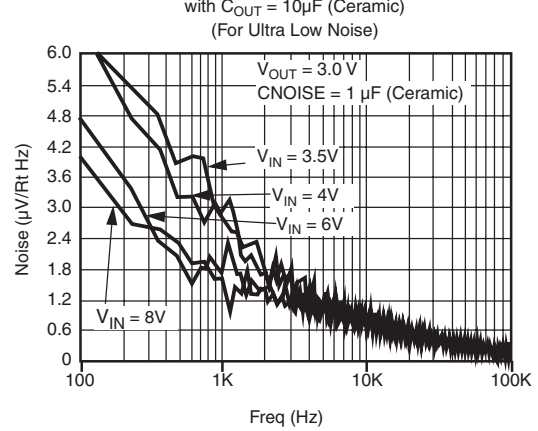

Typical Performance Characteristics

Unless otherwise specified $T_A = 25^\circ\text{C}$, $V_{IN} = V_{OUT(NOM)} + 1\text{V}$, ON/OFF pin tied to V_{IN} .
 Characterization at output currents above 50mA applies to ILC7081.

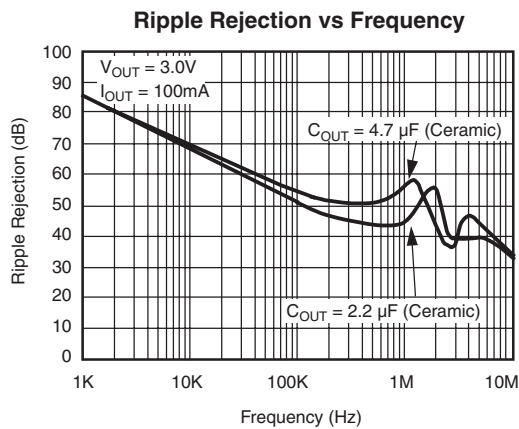
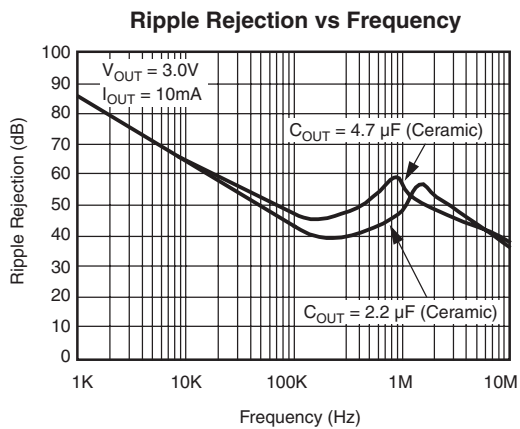

Package Outline Dimensions

Dimensions shown in inches and (mm).

5-Lead plastic surface mount (SOT-23-5)

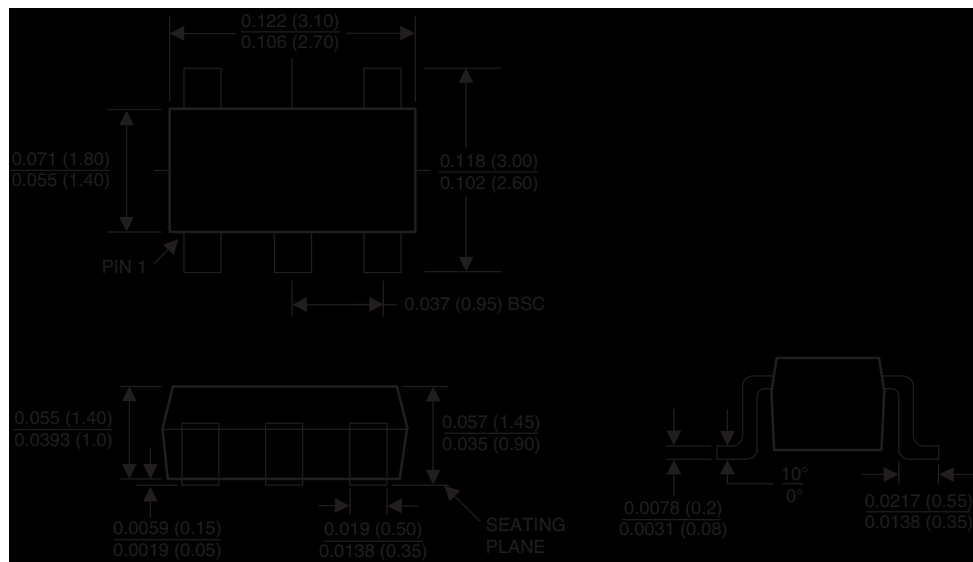

Ordering Information ($T_A = -40^{\circ}\text{C}$ to $+85^{\circ}\text{C}$)

ILC7080AIM5-xx

Output voltage (V)	Grade	Order Information	*Package Marking	Supplied as:
2.6	A	ILC7080AIM526x	Clx	3k Units on Tape and Reel
2.7	A	ILC7080AIM527x	CMx	3k Units on Tape and Reel
2.8	A	ILC7080AIM528x	CJ0x	3k Units on Tape and Reel
2.85	A	ILC7080AIM5285x	CFx	3k Units on Tape and Reel
2.9	A	ILC7080AIM529x	CKx	3k Units on Tape and Reel
3.0	A	ILC7080AIM530x	CAx	3k Units on Tape and Reel
3.1	A	ILC7080AIM531x	CLx	3k Units on Tape and Reel
3.3	A	ILC7080AIM533x	CBx	3k Units on Tape and Reel
5.0	A	ILC7080AIM550x	CCx	3k Units on Tape and Reel

* Note: First two characters identify the product and the last character identifies the lot code

ILC7081AIM5-xx

Output voltage (V)	Grade	Order Information	*Package Marking	Supplied as:
2.5	A	ILC7081AIM525x	CXx	3k Units on Tape and Reel
2.6	A	ILC7081AIM526x	CPx	3k Units on Tape and Reel
2.7	A	ILC7081AIM527x	CNx	3k Units on Tape and Reel
2.8	A	ILC7081AIM528x	CJx	3k Units on Tape and Reel
2.85	A	ILC7081AIM5285x	CVx	3k Units on Tape and Reel
2.9	A	ILC7081AIM529x	COx	3k Units on Tape and Reel
3.0	A	ILC7081AIM530x	CQx	3k Units on Tape and Reel
3.1	A	ILC7081AIM531x	CYx	3k Units on Tape and Reel
3.3	A	ILC7081AIM533x	CRx	3k Units on Tape and Reel
3.6	A	ILC7081AIM536x	CTx	3k Units on Tape and Reel
4.7	A	ILC7081AIM547x	CWx	3k Units on Tape and Reel
5.0	A	ILC7081AIM550x	CSx	3k Units on Tape and Reel
ADJ	A	ILC7081AIM5ADJx	CUx	3k Units on Tape and Reel

* Note: First two characters identify the product and the last character identifies the lot code

Summary

ILC7080AIM5xx	50mA, fixed voltage
ILC7081AIM5xx	100mA, fixed voltage
ILC7081AIM5ADJ	100mA, adjustable voltage

DISCLAIMER

FAIRCHILD SEMICONDUCTOR RESERVES THE RIGHT TO MAKE CHANGES WITHOUT FURTHER NOTICE TO ANY PRODUCTS HEREIN TO IMPROVE RELIABILITY, FUNCTION OR DESIGN. FAIRCHILD DOES NOT ASSUME ANY LIABILITY ARISING OUT OF THE APPLICATION OR USE OF ANY PRODUCT OR CIRCUIT DESCRIBED HEREIN; NEITHER DOES IT CONVEY ANY LICENSE UNDER ITS PATENT RIGHTS, NOR THE RIGHTS OF OTHERS.

LIFE SUPPORT POLICY

FAIRCHILD'S PRODUCTS ARE NOT AUTHORIZED FOR USE AS CRITICAL COMPONENTS IN LIFE SUPPORT DEVICES OR SYSTEMS WITHOUT THE EXPRESS WRITTEN APPROVAL OF THE PRESIDENT OF FAIRCHILD SEMICONDUCTOR CORPORATION. As used herein:

1. Life support devices or systems are devices or systems which, (a) are intended for surgical implant into the body, or (b) support or sustain life, and (c) whose failure to perform when properly used in accordance with instructions for use provided in the labeling, can be reasonably expected to result in a significant injury of the user.
2. A critical component in any component of a life support device or system whose failure to perform can be reasonably expected to cause the failure of the life support device or system, or to affect its safety or effectiveness.