



FEATURES:

- Suitable for RoHS reflow profile
- High current rating and low DCR
- Special lead wire design to prevent open circuit failure
- Excellent terminal strength to mechanical stress

APPLICATIONS:

- OA equipments
- PC and notebook
- LCD TV set
- Power supply

ELECTRICAL SPECIFICATIONS:

Abracon P/N:	ASPI-0504 Series
Operating Temperature:	-40°C to +85°C
Storage Temperature:	+5°C to +40°C (In Tape and Reel)

PART NUMBER ASPI-0504- Inductance Code	Inductance (uH)	Test Frequency	Tolerance	DCR (Ω) max	IDC (A) max
ASPI-0504-4R7	4.7	7.96MHz	K, M	0.04	3.50
ASPI-0504-100	10	2.52MHz	K, M	0.10	1.44
ASPI-0504-120	12	2.52MHz	K, M	0.12	1.40
ASPI-0504-150	15	2.52MHz	K, M	0.14	1.30
ASPI-0504-180	18	2.52MHz	K, M	0.15	1.23
ASPI-0504-220	22	2.52MHz	K, M	0.18	1.11
ASPI-0504-270	27	2.52MHz	K, M	0.20	0.97
ASPI-0504-330	33	2.52MHz	K, M	0.23	0.88
ASPI-0504-390	39	2.52MHz	K, M	0.32	0.80
ASPI-0504-470	47	2.52MHz	K, M	0.37	0.72
ASPI-0504-560	56	2.52MHz	K	0.42	0.68
ASPI-0504-680	68	2.52MHz	K	0.46	0.61
ASPI-0504-820	82	2.52MHz	K	0.60	0.58
ASPI-0504-101	100	1KHz	K	0.70	0.52
ASPI-0504-121	120	1KHz	K	0.93	0.48
ASPI-0504-151	150	1KHz	K	1.10	0.40
ASPI-0504-181	180	1KHz	K	1.38	0.38
ASPI-0504-221	220	1KHz	K	1.57	0.35
ASPI-0504-102	1000	1KHz	M	14.4	0.15

Test Conditions

Inductance: 100kHz

Isat: ΔL/L (initial) ≥ -10% or ΔT=40°C (Ta=20°C), whichever is lower.

OPTIONS AND PART IDENTIFICATION

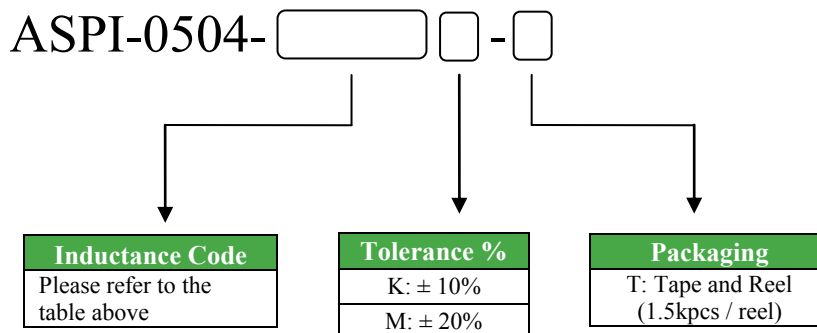



OUTLINE DRAWING:

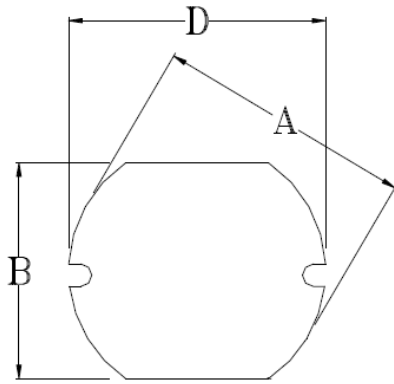

A	B	C	D	E	F	G
5.8±0.3	5.2±0.3	4.5±0.35	5.8±0.3	1.80	1.90	5.00

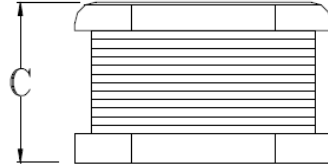

Recommended Land Pattern

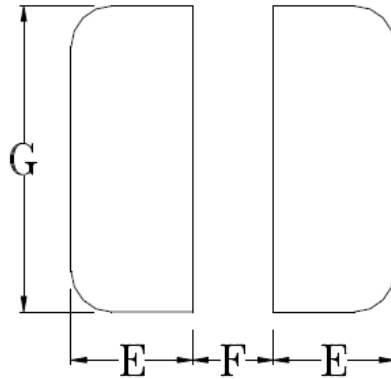
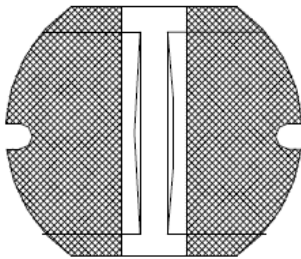

Dimension: mm

REFLOW PROFILE:

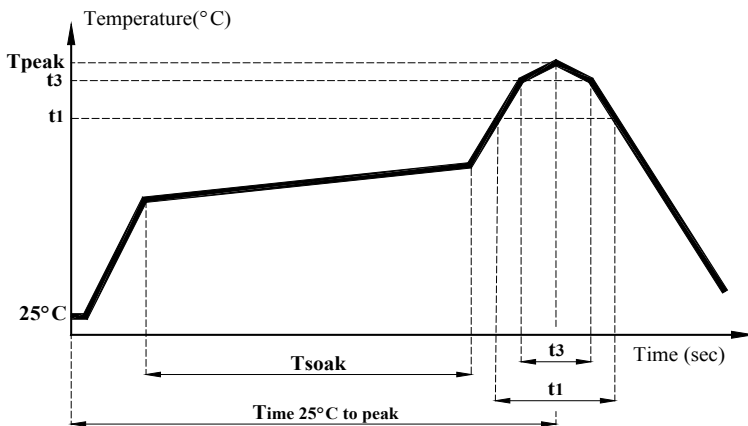

Item	mark	
Temperature rise gradient		3°C/sec (max)
Heating time	Tsoak	50s ~ 150s
Heating temperature		120°C~180°C
Time over 217°C	t1	70 sec
Time within 5°C of actual peak temperature	t3	10~30 sec
Peak temperature	Tpeak	250 (+0 / -5 °C)
Time 25°C to peak Temperature		6 minutes max.



TAPE & REEL:

T: 1,500pcs / reel

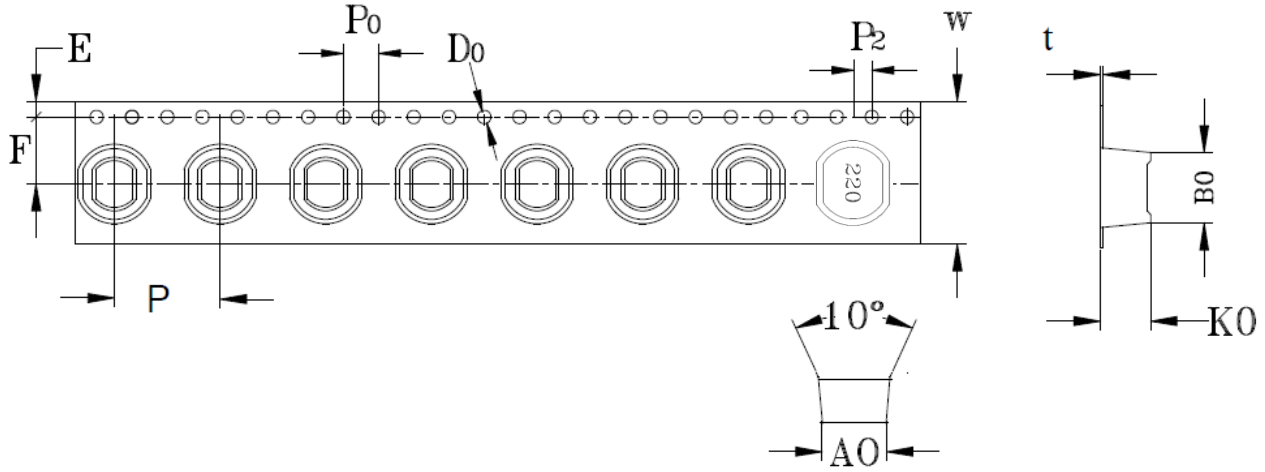

A0	B0	K0	F	E	W	P	Po	P2	t
5.4 ± 0.1	6.0 ± 0.1	4.8 ± 0.1	5.5 ± 0.1	1.75 ± 0.1	12 ± 0.3	8 ± 0.1	4 ± 0.1	2 ± 0.1	0.4 ± 0.05

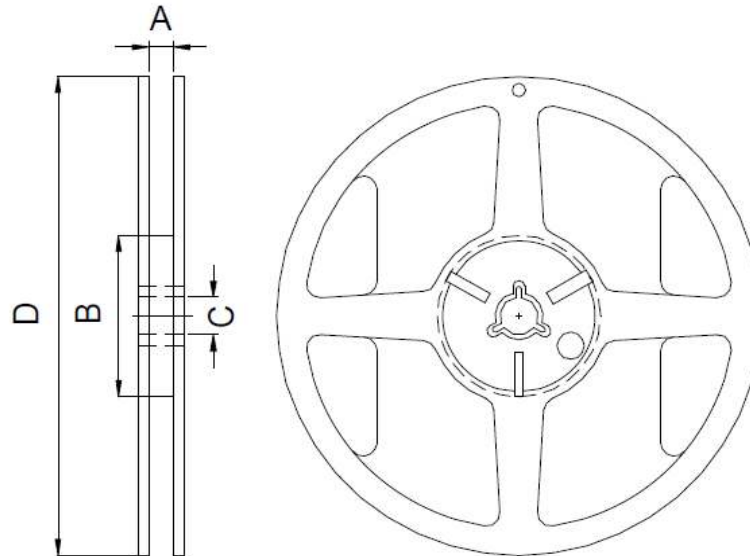

A	B	C	D
12.5 ± 0.2	100 ± 0.5	13.2 ± 0.3	330 ± 1.0

Dimension: mm

ATTENTION Abracon Corporation's products are COTS – Commercial-Off-The-Shelf products; suitable for Commercial, Industrial and, where designated, Automotive Applications. Abracon's products are not specifically designed for Military, Aviation, Aerospace, Life-dependant Medical applications or any application requiring high reliability where component failure could result in loss of life and/or property. For applications requiring high reliability and/or presenting an extreme operating environment, written consent and authorization from Abracon Corporation is required. Please contact Abracon Corporation for more information.