

REV
A DTM06-08S*-E007

REVISIONS			
SYM	DESCRIPTION	DATE	APPROVED
NC	NEW RELEASE PER E.O. P17176	3/16/01	R.D.R.
A	REVISED PER E.O. P20732	3-25-11	RDR

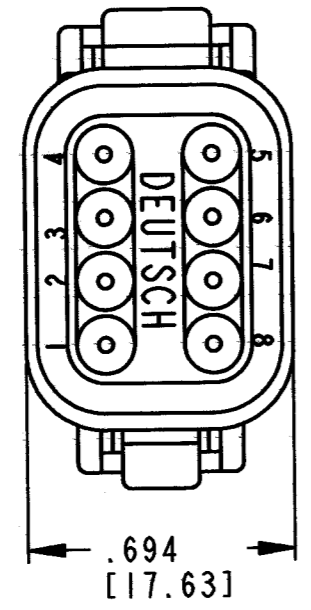

8
EXTENDED
CAP

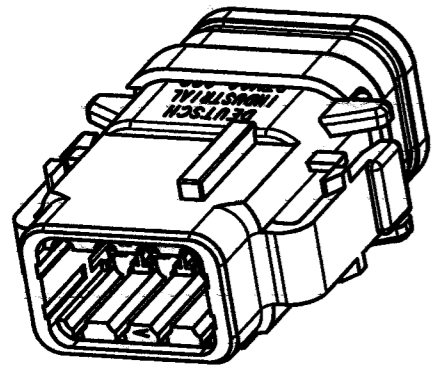
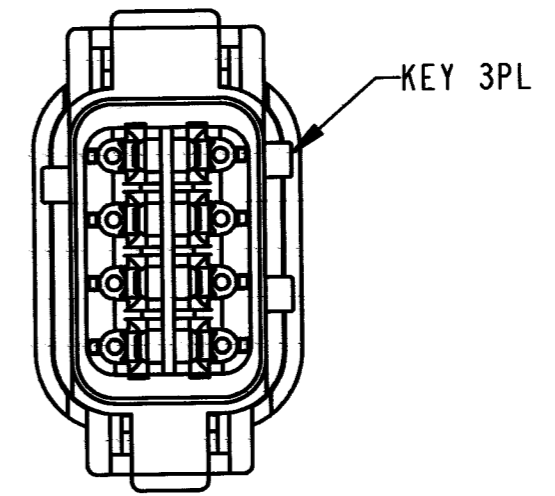
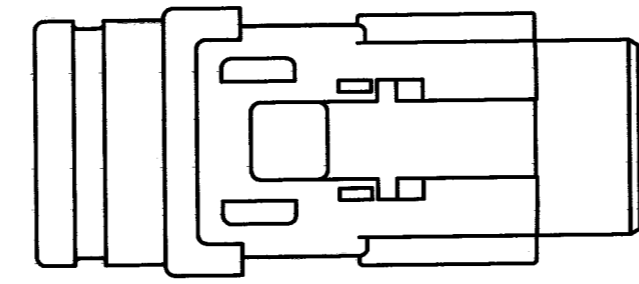
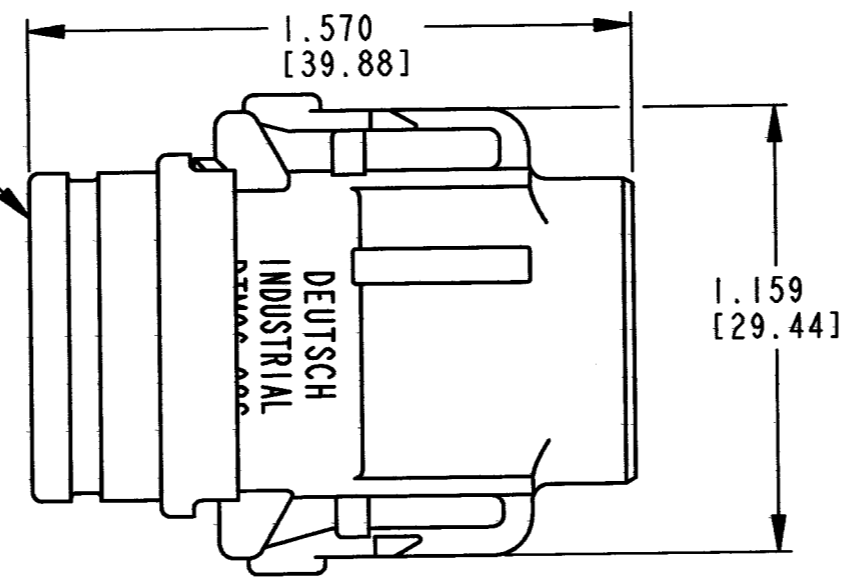
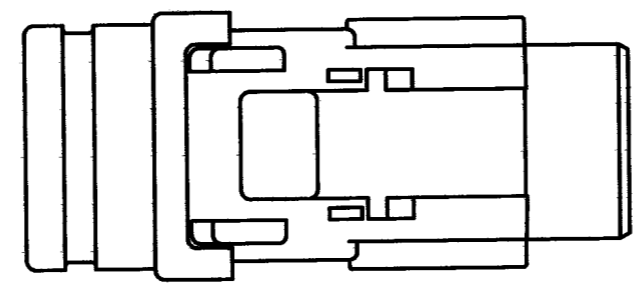

8. PART MODIFICATION.

- 7. SEE SHEET 2 FOR OTHER KEY ARRANGEMENT.
- 6. MATERIAL - HOUSING/EXTENDED CAP: PLASTIC; GROMMET: RUBBER.
- 5. THIS PLUG MATES WITH DTM04-08P*-**** RECEPTACLE.
(* = A,B,C,D KEYS; **** = ALL MODIFICATIONS)

4. FOR CONTACT AND WIRE PERFORMANCE AND APPLICATION CHARACTERISTICS SEE ENVELOPE DRAWING 0425-015-0000.

- 3. SECONDARY WEDGE LOCK SOLD SEPARATELY: WM-8S.
- 2. DIMENSION TOLERANCE: ±.025 [.64].
- 1. DIMENSIONS ARE IN INCHES [mm].

NOTES: UNLESS OTHERWISE SPECIFIED

CONTACT SIZE	MIN. INSUL. O.D.	MAX. INSUL. O.D.	WIRE RANGE [mm ²] REF ONLY
20	.053 [1.35]	.120 [3.05]	16-20 AWG [1.0-0.5]

SIGNATURE & DATE	
DR	D. MEYER 03/09/01
CHK	<i>[Signature]</i> 3/23/2011
PE	<i>[Signature]</i> 3/16/11
APPD	<i>[Signature]</i> 3/18/11
SCALE	NONE WT

PLUG W/EXTENDED CAP
8 CONTACTS, SIZE 20
A,B,C,D KEYS
-E007 MOD
DTM SERIES

ENVELOPE

EP	MATL. CODE
3850 INDUSTRIAL AVE. HEMET, CA 92545	
B DTM06-08S*-E007	
DWG SIZE	CODE 11139 SHEET 1 OF 2

REV A	DTM06-08S*-E007	REVISIONS			
		SYM	DESCRIPTION	DATE	APPROVED
		A	SEE SHEET 1	3-25-11	RDR

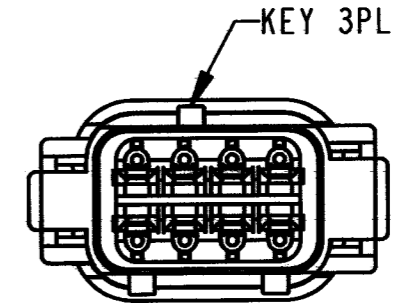
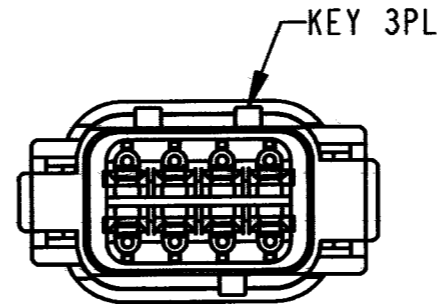
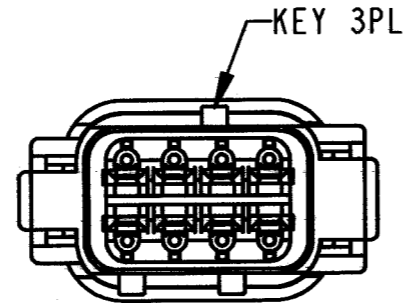
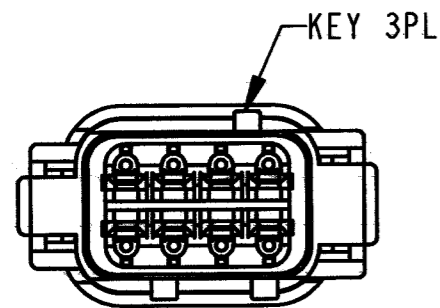
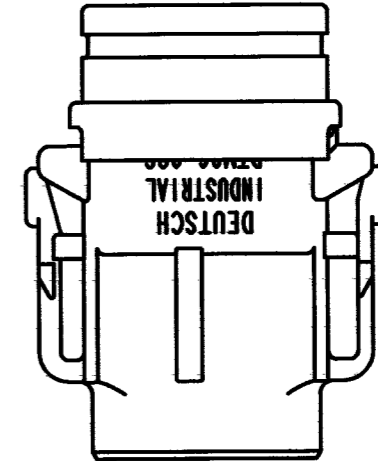
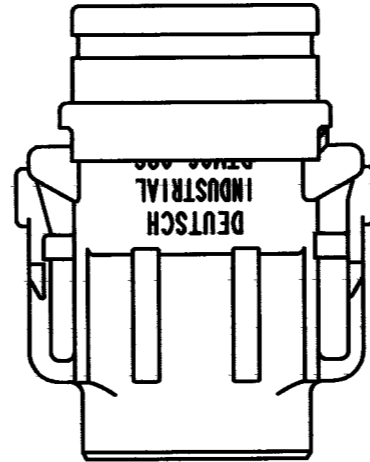
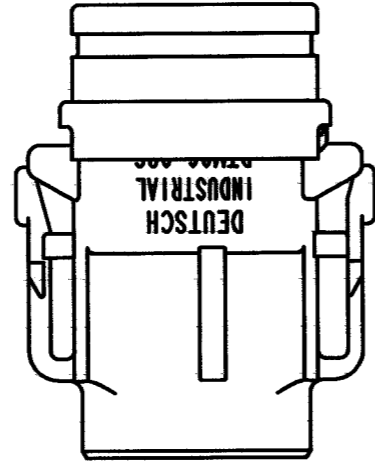
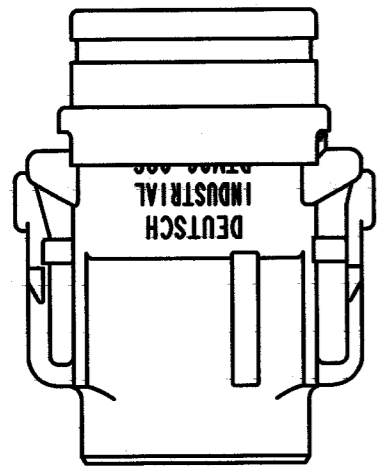

DTM06-08SA-E007
KEY -A-
COLOR: GREY

DTM06-08SB-E007
KEY -B-
COLOR: BLACK

DTM06-08SC-E007
KEY -C-
COLOR: GREEN

DTM06-08SD-E007
KEY -D-
COLOR: BROWN

NOTES:

SIGNATURE & DATE		PLUG W/EXTENDED CAP 8 CONTACTS, SIZE 20 A, B, C, D KEYS -E007 MOD DTM SERIES	EP	MATL. CODE
DR	D. MEYER 03/09/01		3850 INDUSTRIAL AVE. HEMET, CA 92545	
CHK	B. Boyd 3/23/2011		DEUTSCH INDUSTRIAL	
PE	R. Milligan 3/16/11		B DTM06-08S*-E007	
APPD	S. Beard 3/18/11		DWG SIZE	CODE 11139
SCALE	NONE	WT	ENVELOPE	