

XS7D1A3CAM12DIN

Inductive proximity sensors XS, inductive sensor XS7 80x80x26, PBT, Sn50mm, 10...48 VDC, M12



Main

Range of Product	Telemecanique Inductive proximity sensors XS
Series name	Application
Sensor Type	Inductive proximity sensor
Device Application	-
Sensor name	XS7
Sensor design	Flat form 80 x 80 x 40
Size	40 mm
Body type	Fixed clippable onto DIN rail
Detector flush mounting acceptance	Flush mountable
Material	Plastic
Enclosure Material	PBT
Type of output signal	Discrete
Wiring Technique	2-wire
[Sn] nominal sensing distance	1.97 in (50 mm) flush mountable 1.97 in (50 mm) non flush mountable
Discrete output function	1 NO
Output circuit type	DC
Electrical connection	Male connector M12, 4 pins
[Us] rated supply voltage	10...48 V DC reverse polarity protection
Switching capacity in mA	1.5...300 mA overload and short-circuit protection
IP degree of protection	IP67 double insulation conforming to IEC 60529

Complementary

Detection face	Frontal
Front material	PBT
Operating zone	0.00...1.57 in (0...40 mm)
Differential travel	1...15% of Sr
Repeat accuracy	3% of Sr
Status LED	Output state 1 LED yellow)
Supply voltage limits	10...58 V DC
Maximum residual current	0.5 mA open state
Switching frequency	<= 100 Hz
Maximum voltage drop	<4.5 V closed)
Maximum delay first up	10 ms
Maximum delay response	2 ms
Maximum delay recovery	5 ms
Marking	CE
Depth	1.57 in (40 mm)
Height	3.15 in (80 mm)
Width	3.15 in (80 mm)
Net Weight	0.82 lb(US) (0.374 kg)

The information provided in this documentation contains general descriptions and/or technical characteristics of the performance of the products contained herein. This documentation is not intended as a substitute for and is not to be used for determining suitability or reliability of these products for specific user applications. It is the duty of any such user or integrator to perform the appropriate and complete risk analysis, evaluation and testing of the products with respect to the relevant specific application or use thereof. Neither Schneider Electric Industries SAS nor any of its affiliates or subsidiaries shall be responsible or liable for misuse of the information contained herein.

Environment

Ambient Air Temperature for Operation	-13...158 °F (-25...70 °C)
Ambient Air Temperature for Storage	-40...185 °F (-40...85 °C)
Vibration resistance	25 gn +/- 2 mm 10...55 Hz)IEC 60068-2-6
Shock resistance	50 gn 11 ms IEC 60068-2-27

Ordering and shipping details

Category	22486-SENSORS, PROXIMITY
Discount Schedule	DS2
GTIN	3389110709643
Nbr. of units in pkg.	1
Package weight(Lbs)	12.17 oz (345.0 g)
Returnability	No
Country of origin	FR

Packing Units

Unit Type of Package 1	PCE
Package 1 Height	1.69 in (4.3 cm)
Package 1 width	3.78 in (9.6 cm)
Package 1 Length	5.20 in (13.2 cm)
Unit Type of Package 2	S02
Number of Units in Package 2	22
Package 2 Weight	17.74 lb(US) (8.045 kg)
Package 2 Height	5.91 in (15 cm)
Package 2 width	11.81 in (30 cm)
Package 2 Length	15.75 in (40 cm)

Offer Sustainability

Sustainable offer status	Green Premium product
California proposition 65	WARNING: This product can expose you to chemicals including: Diisononyl phthalate (DINP), which is known to the State of California to cause cancer, and Di-isodecyl phthalate (DIDP), which is known to the State of California to cause birth defects or other reproductive harm. For more information go to www.P65Warnings.ca.gov
REACH Regulation	REACH Declaration
EU RoHS Directive	Pro-active compliance (Product out of EU RoHS legal scope) EU RoHS Declaration
Mercury free	Yes
RoHS exemption information	Yes
Environmental Disclosure	Product Environmental Profile

Contractual warranty

Warranty	18 months
----------	-----------

Dimensions

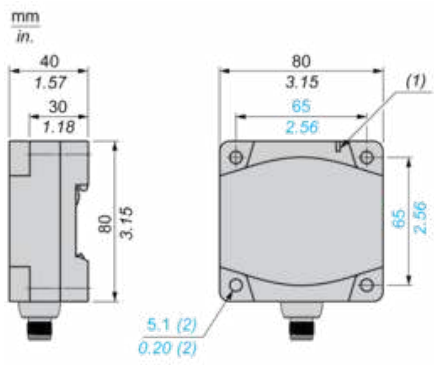

(1) Output LED

(2) For CHC type screws

Setting-up

Minimum Mounting Distances (mm)

Face to Face

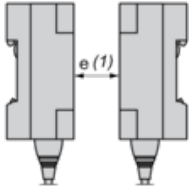

Side by Side

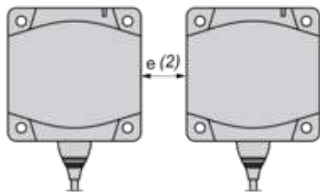

Back to back

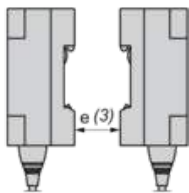

Facing a Metal Object

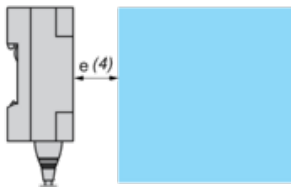

	e (1)	e (2)	e (3)	e (4)
Flush mounted	450	140	90	150
Not flush mounted	450	180	180	150

Flush Conditions

In A37 Steel

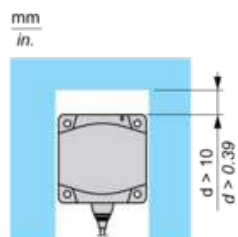

Wiring Schemes

3-Wire Connection

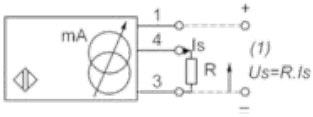

(1) Voltage output

Ensure a minimum of 5 V between the + (terminal 1) and the sensor output (terminal 4)

	Output current	Load impedance value	Output voltage	Load impedance value
24 V	0...10 mA	$R \leq 1400 \Omega$	0...10 V	$R = 1000 \Omega$

M8

