

RIF-2-RPT-LDP-24DC/4X21 AU - Relay Module



2908332

<https://www.phoenixcontact.com/us/products/2908332>

Please be informed that the data shown in this PDF document is generated from our online catalog. Please find the complete data in the user documentation. Our general terms of use for downloads are valid.



Preassembled relay module with Push-in connection, consisting of: relay base, power contact relay with additional hard gold plating, and retaining bracket. Contact switching type: 4 changeover contacts. Input voltage: 24 V DC

Product description

The pluggable electromechanical and solid-state relays in the RIFLINE complete product range and the base are recognized and approved in accordance with UL 508. The relevant approvals can be called up at the individual components in question.

Commercial data

Item number	2908332
Packing unit	1 pc
Minimum order quantity	10 pc
Sales key	C465
Product key	CK652A
GTIN	4055626293011
Weight per piece (including packing)	104.61 g
Weight per piece (excluding packing)	104.61 g
Customs tariff number	85364110
Country of origin	PL

Technical data

Product properties

Product type	Relay Module
Product family	RIFLINE complete
Application	Universal
Operating mode	100% operating factor
Mechanical service life	approx. 2×10^7 cycles

Insulation characteristics

Insulation	Basic insulation
------------	------------------

Insulation characteristics

Insulation	Basic insulation
Overvoltage category	II
Pollution degree	2

Electrical properties

Maximum power dissipation for nominal condition	1.01 W
Test voltage (Winding/contact)	2.5 kV _{rms} (50 Hz, 1 min., winding/contact)
Test voltage (Contact/contact)	2 kV _{rms} (50 Hz, 1 min., contact/contact)
Rated insulation voltage	250 V AC
Rated surge voltage	2.5 kV

Input data

Coil side

Nominal input voltage U_N	24 V DC
Input voltage range	19.2 V DC ... 30 V DC (20 °C)
Input voltage range in reference to U_N	see diagram
Drive and function	monostable
Drive (polarity)	polarized
Typical input current at U_N	42 mA
Typical response time	13 ms
Typical release time	14 ms
Protective circuit	Freewheeling diode
Status display	Yellow LED

Output data

Switching

Contact switching type	4 changeover contacts
Type of switch contact	Single contact
Contact material	AgNi, hard gold-plated
Note	If the specified maximum values for multi-layer contact relays are exceeded, the gold plating is destroyed. The maximum values of

RIF-2-RPT-LDP-24DC/4X21 AU - Relay Module



2908332

<https://www.phoenixcontact.com/us/products/2908332>

	the power contact relay are then valid. This can result in a shorter service life than with a pure power contact.
Maximum switching voltage	30 V AC 36 V DC
Minimum switching voltage	2 V (24 mA)
Limiting continuous current	50 mA
Maximum inrush current	50 mA
Min. switching current	2 mA (24 V)
Interrupting rating (ohmic load) max.	1.2 W (at 24 V DC)
Switching capacity min.	48 mW

Switching: when the gold layer is destroyed

Note	the following values are applicable if a gold layer is destroyed
Contact material	AgNi
Maximum switching voltage	250 V AC/DC
Minimum switching voltage	5 V (At 24 mA)
Limiting continuous current	6 A
Maximum inrush current	16 A (20 ms, N/O contacts)
Min. switching current	5 mA (at 24 V)
Interrupting rating (ohmic load) max.	144 W (at 24 V DC) 124 W (at 48 V DC) 108 W (at 60 V DC) 52 W (at 110 V DC) 48 W (at 220 V DC) 1500 VA (for 250 V AC)
Switching capacity	2 A (at 24 V, DC13) 0.22 A (at 120 V, DC13) 0.11 A (at 250 V, DC13) 1.5 A (at 24 V, AC15) 1.5 A (at 120 V, AC15) 1 A (at 240 V, AC15)

Connection data

Connection method	Push-in connection
Stripping length	8 mm
Conductor cross section rigid	0.14 mm ² ... 1.5 mm ²
Conductor cross section flexible	0.14 mm ² ... 1.5 mm ² 0.14 mm ² ... 1.5 mm ² (Ferrule with plastic sleeve) 0.14 mm ² ... 1 mm ² (Ferrule with plastic sleeve, two conductors on double terminal block)
Conductor cross section AWG	26 ... 16 (solid) 26 ... 16 (flexible)

Dimensions

RIF-2-RPT-LDP-24DC/4X21 AU - Relay Module



2908332

<https://www.phoenixcontact.com/us/products/2908332>

Drill hole

Diameter	3.2 mm
Width	31 mm
Height	96 mm
Depth	75 mm

Material specifications

Flammability rating according to UL 94	V2 (Housing)
--	--------------

Environmental and real-life conditions

Ambient conditions

Degree of protection (Relay base)	IP20 (Relay base)
Degree of protection (Relay)	RT I (Relay)
Ambient temperature (operation)	-40 °C ... 60 °C
Ambient temperature (storage/transport)	-40 °C ... 85 °C

Approvals

Corrosive gas test

Identification	ISA-S71.04. G3 Harsh Group
	EN 60068-2-60

Standards and regulations

Standards/regulations	IEC 60947-5-1
-----------------------	---------------

Mounting

Mounting type	DIN rail mounting
Assembly instructions	in rows with zero spacing
Mounting position	any

Drawings

Diagram

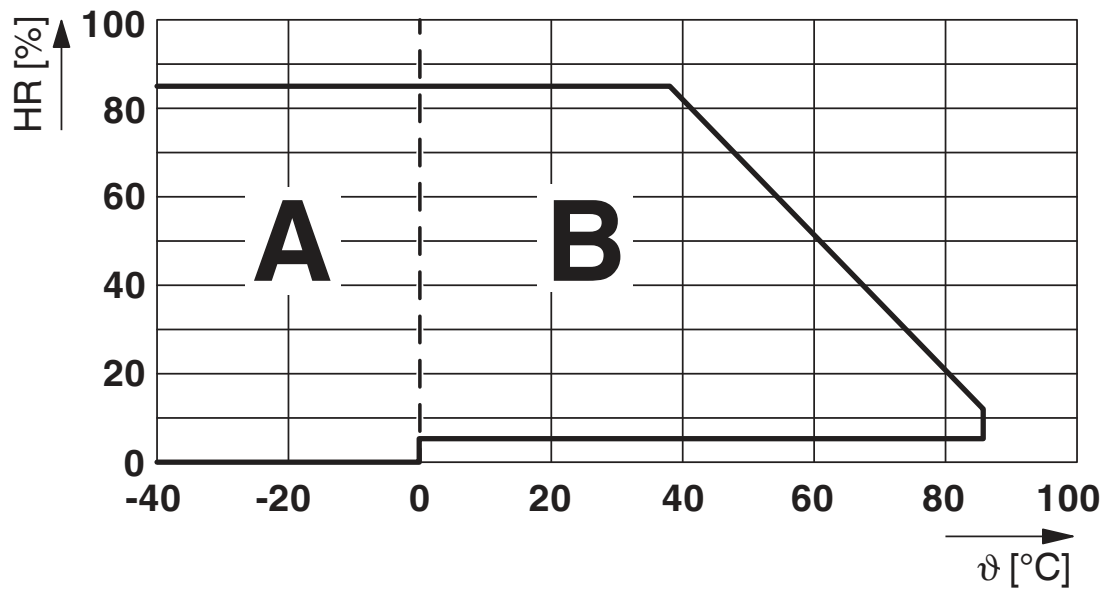

Permissible humidity for operation and storage.

The maximum permissible ambient temperature as specified in the data sheet must be observed.

Area A: Ice buildup at ambient temperatures $\leq 0^\circ\text{C}$ must be prevented

Area B: Condensation at ambient temperatures $> 0^\circ\text{C}$ must be prevented

On 30 full days that are naturally distributed across an entire year, a humidity level of 95% is permissible at an ambient temperature $\leq 25^\circ\text{C}$.

2908332

<https://www.phoenixcontact.com/us/products/2908332>

Diagram

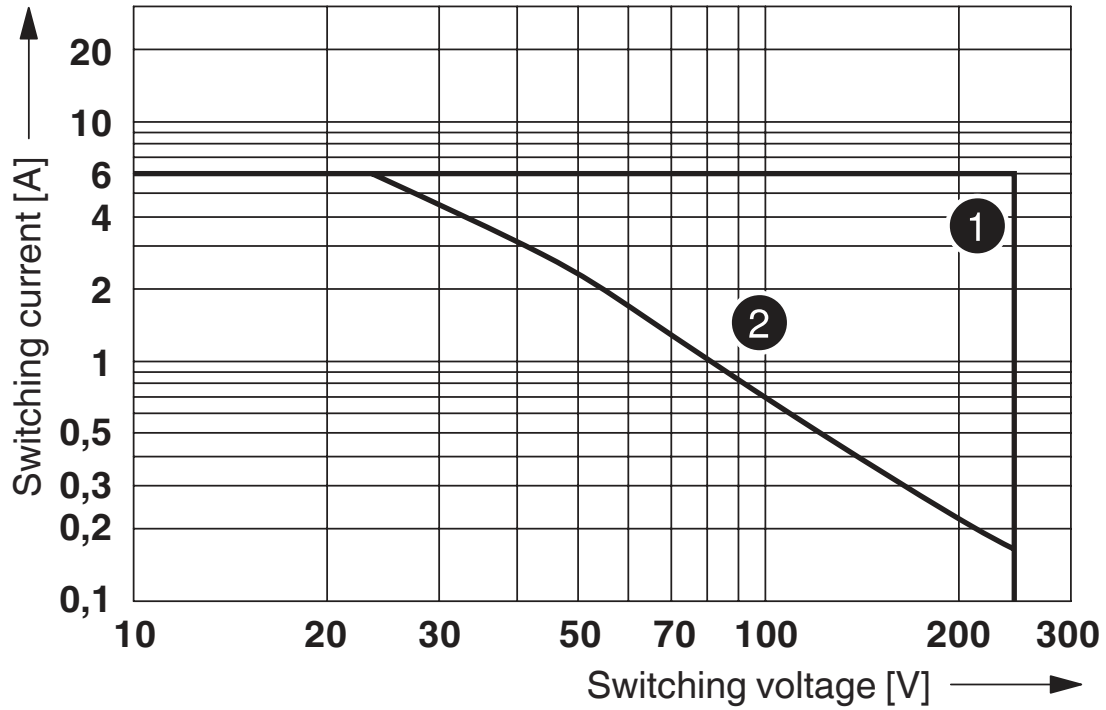

- ① AC, ohmic load
- ② DC, ohmic load

Interrupting rating

Diagram

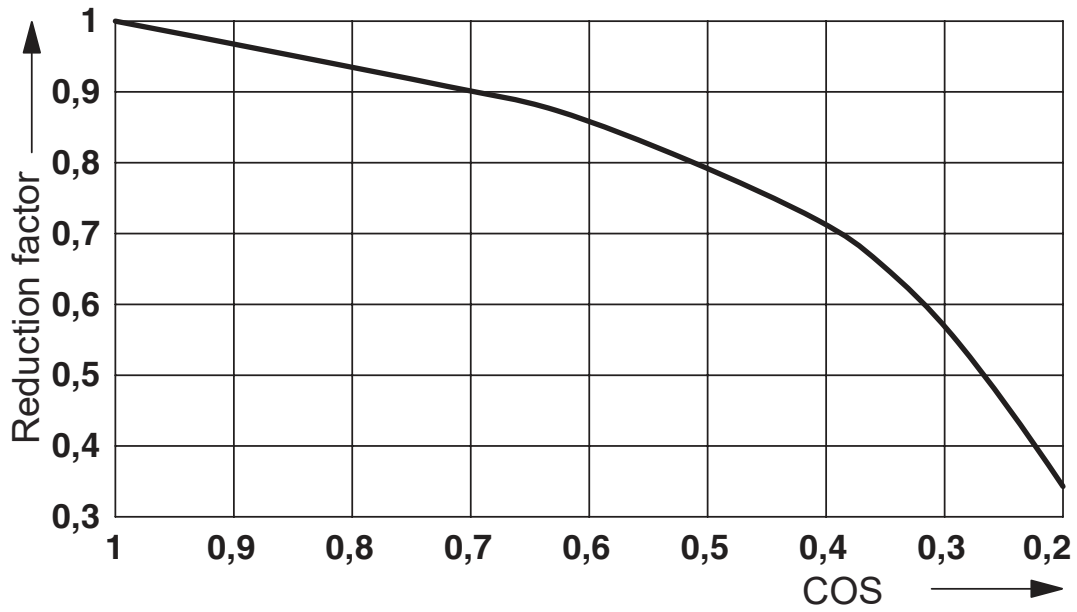

Service life reduction factor

Diagram

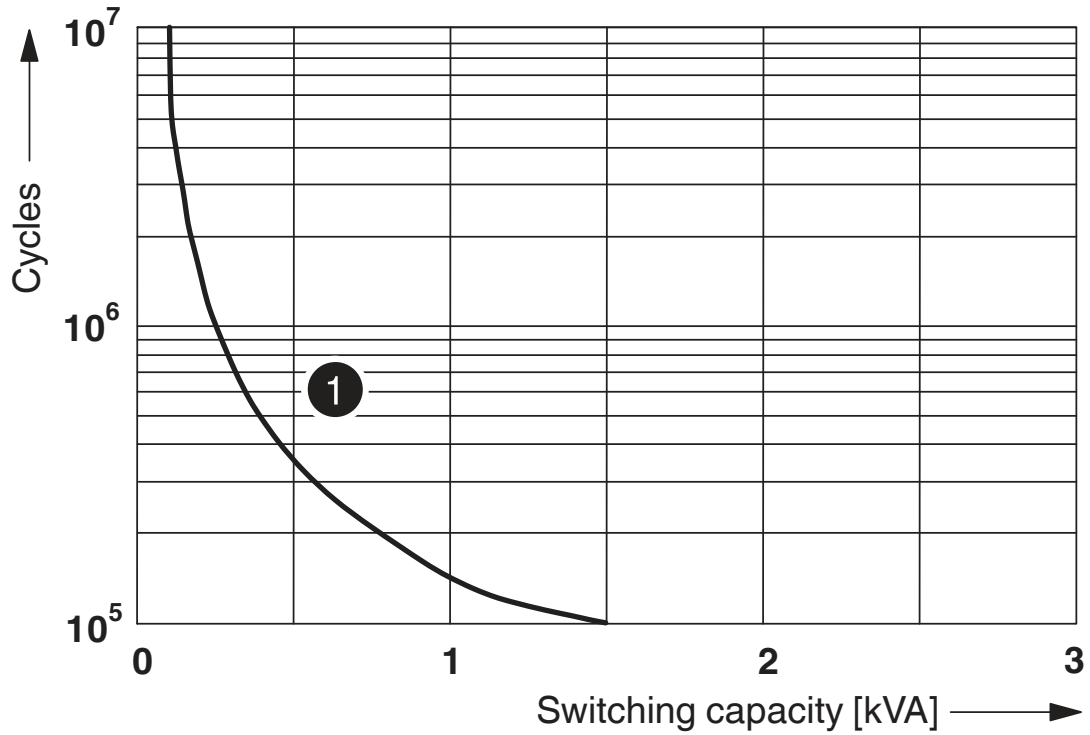

① 250 V AC, Ohmic load

Electrical service life

2908332

<https://www.phoenixcontact.com/us/products/2908332>

Diagram

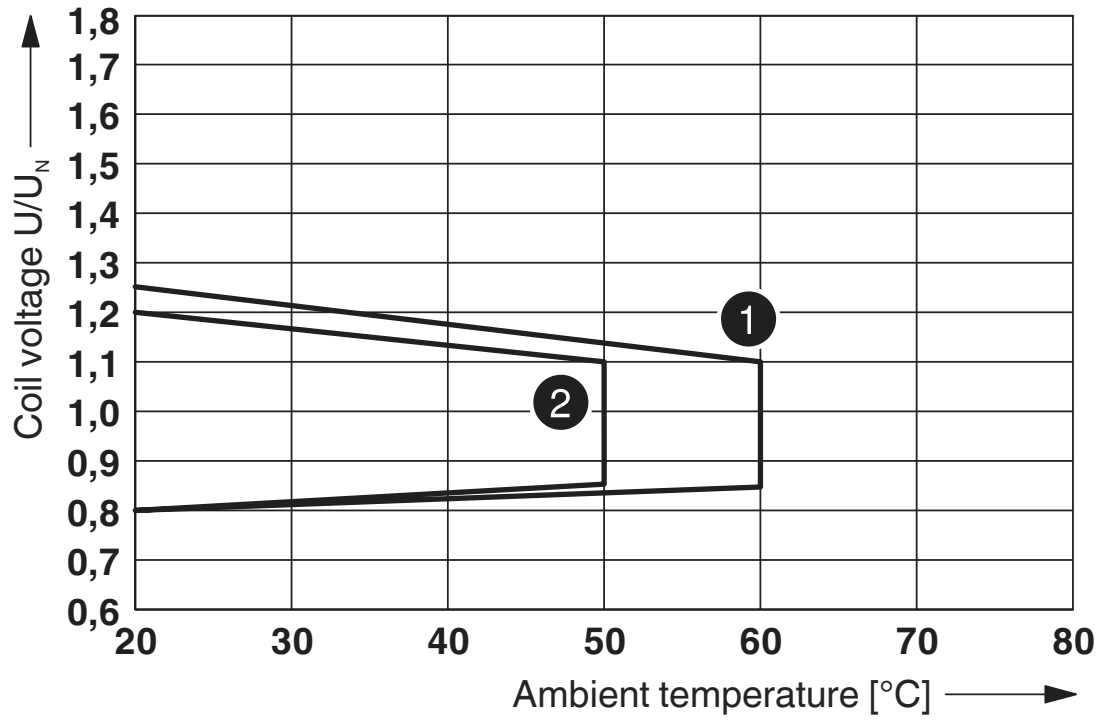

- ① DC coil (observe contact derating)
- ② AC coil (observe contact derating)

Operating voltage range

2908332

<https://www.phoenixcontact.com/us/products/2908332>

Circuit diagram

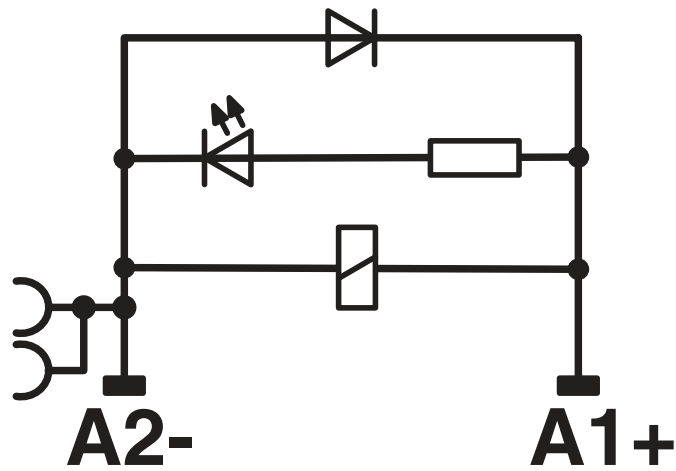
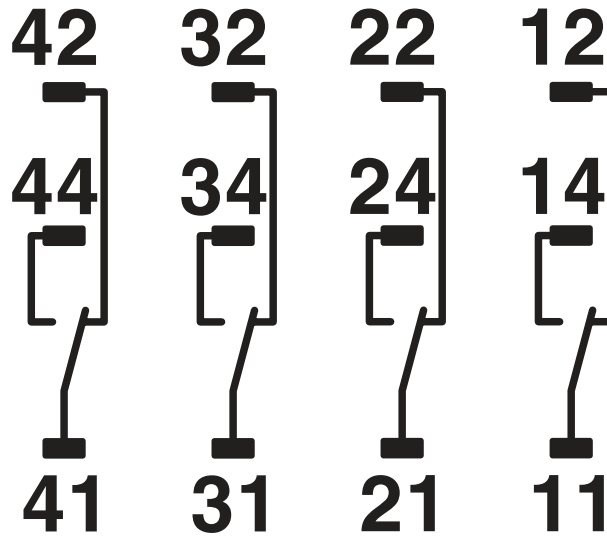

2908332

<https://www.phoenixcontact.com/us/products/2908332>

Approvals

To download certificates, visit the product detail page: <https://www.phoenixcontact.com/us/products/2908332>



EAC

Approval ID: TR_TS_D_00573_c



DNV GL

Approval ID: TAA000018V



EAC

Approval ID: RU*C-DE.*08.B.00010

2908332

<https://www.phoenixcontact.com/us/products/2908332>

Classifications

ECLASS

ECLASS-11.0	27371601
ECLASS-12.0	27371601
ECLASS-13.0	27371601

ETIM

ETIM 8.0	EC001437
----------	----------

UNSPSC

UNSPSC 21.0	39122300
-------------	----------

RIF-2-RPT-LDP-24DC/4X21 AU - Relay Module



2908332

<https://www.phoenixcontact.com/us/products/2908332>

Environmental product compliance

China RoHS	Environmentally friendly use period: unlimited = EFUP-e
	No hazardous substances above threshold values

RIF-2-RPT-LDP-24DC/4X21 AU - Relay Module



2908332

<https://www.phoenixcontact.com/us/products/2908332>

Accessories

FBS 2-6 - Plug-in bridge

3030336

<https://www.phoenixcontact.com/us/products/3030336>



Plug-in bridge, pitch: 6.2 mm, number of positions: 2, color: red

FBS 2-6 BU - Plug-in bridge

3036932

<https://www.phoenixcontact.com/us/products/3036932>



Plug-in bridge, pitch: 6.2 mm, number of positions: 2, color: blue

RIF-2-RPT-LDP-24DC/4X21 AU - Relay Module



2908332

<https://www.phoenixcontact.com/us/products/2908332>

FBS 2-6 GY - Plug-in bridge

3032237

<https://www.phoenixcontact.com/us/products/3032237>



Plug-in bridge, pitch: 6.2 mm, number of positions: 2, color: gray

STP 5-2 - Marker carriers

0800967

<https://www.phoenixcontact.com/us/products/0800967>



Marker carriers, snaps into STTB 2,5, STTB 4, PTTB 2,5, and PTTB 4 double-level spring-cage terminal blocks, can be marked with UC-TM 5, UC-TMF 5, UCT-TM 5, UCT-TMF 5, ZB 5, or ZBF 5, gray, unlabeled, mounting type: plug in, lettering field size: 5 x 10.5 mm

RIF-2-RPT-LDP-24DC/4X21 AU - Relay Module



2908332

<https://www.phoenixcontact.com/us/products/2908332>

NS 35/ 7,5 PERF 2000MM - DIN rail perforated

0801733

<https://www.phoenixcontact.com/us/products/0801733>



DIN rail perforated, acc. to EN 60715, material: Steel, galvanized, passivated with a thick layer, Standard profile, color: silver, Pack of 25 (50 m)

NS 35/ 7,5 UNPERF 2000MM - DIN rail, unperforated

0801681

<https://www.phoenixcontact.com/us/products/0801681>



DIN rail, unperforated, acc. to EN 60715, material: Steel, galvanized, passivated with a thick layer, Standard profile, color: silver, Pack of 25 (50 m)

RIF-2-RPT-LDP-24DC/4X21 AU - Relay Module



2908332

<https://www.phoenixcontact.com/us/products/2908332>

NS 35/ 7,5 WH PERF 2000MM - DIN rail perforated

1204119

<https://www.phoenixcontact.com/us/products/1204119>



DIN rail perforated, acc. to EN 60715, material: Steel, Galvanized, white passivated, Standard profile, color: silver, Pack of 25 (50 m)

NS 35/ 7,5 WH UNPERF 2000MM-VPE 10 - DIN rail, unperforated

1204122

<https://www.phoenixcontact.com/us/products/1204122>



DIN rail, unperforated, acc. to EN 60715, material: Steel, Galvanized, white passivated, Standard profile, color: silver, Pack of 10 (20 m)

RIF-2-RPT-LDP-24DC/4X21 AU - Relay Module



2908332

<https://www.phoenixcontact.com/us/products/2908332>

NS 35/ 7,5 AL UNPERF 2000MM - DIN rail, unperforated

0801704

<https://www.phoenixcontact.com/us/products/0801704>



DIN rail, unperforated, acc. to EN 60715, material: Aluminum, uncoated, Standard profile, color: silver, Pack of 25 (50 m)

NS 35/ 7,5 ZN PERF 2000MM - DIN rail perforated

1206421

<https://www.phoenixcontact.com/us/products/1206421>



DIN rail perforated, acc. to EN 60715, material: Steel, galvanized, Standard profile, color: silver, Pack of 25 (50 m)

RIF-2-RPT-LDP-24DC/4X21 AU - Relay Module



2908332

<https://www.phoenixcontact.com/us/products/2908332>

NS 35/ 7,5 ZN UNPERF 2000MM - DIN rail, unperforated

1206434

<https://www.phoenixcontact.com/us/products/1206434>



DIN rail, unperforated, acc. to EN 60715, material: Steel, galvanized, Standard profile, color: silver, Pack of 25 (50 m)

NS 35/ 7,5 CU UNPERF 2000MM-VPE 10 - DIN rail, unperforated

0801762

<https://www.phoenixcontact.com/us/products/0801762>



DIN rail, unperforated, acc. to EN 60715, material: Copper, uncoated, Standard profile, color: copper-colored, Pack of 10 (20 m)

RIF-2-RPT-LDP-24DC/4X21 AU - Relay Module



2908332

<https://www.phoenixcontact.com/us/products/2908332>

NS 35/ 7,5 CAP - End cap

1206560

<https://www.phoenixcontact.com/us/products/1206560>

DIN rail end piece, for DIN rail NS 35/7.5



NS 35/15 PERF 2000MM - DIN rail perforated

1201730

<https://www.phoenixcontact.com/us/products/1201730>



DIN rail perforated, similar to EN 60715, material: Steel, galvanized, passivated with a thick layer, Standard profile, color: silver, Pack of 25 (50 m)

RIF-2-RPT-LDP-24DC/4X21 AU - Relay Module



2908332

<https://www.phoenixcontact.com/us/products/2908332>

NS 35/15 UNPERF 2000MM - DIN rail, unperforated

1201714

<https://www.phoenixcontact.com/us/products/1201714>



DIN rail, unperforated, similar to EN 60715, material: Steel, galvanized, passivated with a thick layer, Standard profile, color: silver, Pack of 25 (50 m)

NS 35/15 WH PERF 2000MM - DIN rail perforated

0806602

<https://www.phoenixcontact.com/us/products/0806602>



DIN rail perforated, similar to EN 60715, material: Steel, Galvanized, white passivated, Standard profile, color: white, Pack of 25 (50 m)

RIF-2-RPT-LDP-24DC/4X21 AU - Relay Module



2908332

<https://www.phoenixcontact.com/us/products/2908332>

NS 35/15 WH UNPERF 2000MM-VPE 10 - DIN rail, unperforated

1204135

<https://www.phoenixcontact.com/us/products/1204135>



DIN rail, unperforated, similar to EN 60715, material: Steel, Galvanized, white passivated, Standard profile, color: silver, Pack of 10 (20 m)

NS 35/15 AL UNPERF 2000MM - DIN rail, unperforated

1201756

<https://www.phoenixcontact.com/us/products/1201756>



DIN rail, unperforated, similar to EN 60715, material: Aluminum, uncoated, Standard profile, color: silver

RIF-2-RPT-LDP-24DC/4X21 AU - Relay Module



2908332

<https://www.phoenixcontact.com/us/products/2908332>

NS 35/15 ZN PERF 2000MM - DIN rail perforated

1206599

<https://www.phoenixcontact.com/us/products/1206599>



DIN rail perforated, similar to EN 60715, material: Steel, galvanized, Standard profile, color: silver, Pack of 25 (50 m)

NS 35/15 ZN UNPERF 2000MM - DIN rail, unperforated

1206586

<https://www.phoenixcontact.com/us/products/1206586>



DIN rail, unperforated, similar to EN 60715, material: Steel, galvanized, Standard profile, color: silver, Pack of 25 (50 m)

RIF-2-RPT-LDP-24DC/4X21 AU - Relay Module



2908332

<https://www.phoenixcontact.com/us/products/2908332>

NS 35/15 CU UNPERF 2000MM-VPE 10 - DIN rail, unperforated

1201895

<https://www.phoenixcontact.com/us/products/1201895>



DIN rail, unperforated, similar to EN 60715, material: Copper, uncoated, Standard profile, color: copper-colored, Pack of 10 (20 m)

NS 35/15 CAP - End cap

1206573

<https://www.phoenixcontact.com/us/products/1206573>

DIN rail end piece, for DIN rail NS 35/15



RIF-2-RPT-LDP-24DC/4X21 AU - Relay Module



2908332

<https://www.phoenixcontact.com/us/products/2908332>

NS 35/15-2,3 UNPERF 2000MM-VPE 10 - DIN rail, unperforated

1201798

<https://www.phoenixcontact.com/us/products/1201798>



DIN rail, unperforated, acc. to EN 60715, material: Steel, galvanized, passivated with a thick layer, Standard profile 2.3 mm, color: silver, Pack of 10 (20 m)

CLIPFIX 35 - End clamp

3022218

<https://www.phoenixcontact.com/us/products/3022218>



Quick mounting end clamp for NS 35/7,5 DIN rail or NS 35/15 DIN rail, with marking option, width: 9.5 mm, color: gray

RIF-2-RPT-LDP-24DC/4X21 AU - Relay Module



2908332

<https://www.phoenixcontact.com/us/products/2908332>

CLIPFIX 35-5 - End clamp

3022276

<https://www.phoenixcontact.com/us/products/3022276>



Quick mounting end clamp for NS 35/7,5 DIN rail or NS 35/15 DIN rail, with marking option, with parking option for FBS...5, FBS...6, KSS 5, KSS 6, width: 5.15 mm, color: gray

E/NS 35 N - End clamp

0800886

<https://www.phoenixcontact.com/us/products/0800886>



End clamp, width: 9.5 mm, color: gray

RIF-2-RPT-LDP-24DC/4X21 AU - Relay Module



2908332

<https://www.phoenixcontact.com/us/products/2908332>

MPS-MT - Test plugs

0201744

<https://www.phoenixcontact.com/us/products/0201744>



Test plugs, with solder connection up to 1 mm² conductor cross section, number of positions: 1, color: gray

MPS-IH WH - Insulating sleeve

0201663

<https://www.phoenixcontact.com/us/products/0201663>

Insulating sleeve, color: white



RIF-2-RPT-LDP-24DC/4X21 AU - Relay Module



2908332

<https://www.phoenixcontact.com/us/products/2908332>

MPS-IH RD - Insulating sleeve

0201676

<https://www.phoenixcontact.com/us/products/0201676>

Insulating sleeve, color: red



MPS-IH BU - Insulating sleeve

0201689

<https://www.phoenixcontact.com/us/products/0201689>

Insulating sleeve, color: blue



RIF-2-RPT-LDP-24DC/4X21 AU - Relay Module



2908332

<https://www.phoenixcontact.com/us/products/2908332>

MPS-IH YE - Insulating sleeve

0201692

<https://www.phoenixcontact.com/us/products/0201692>

Insulating sleeve, color: yellow



MPS-IH GN - Insulating sleeve

0201702

<https://www.phoenixcontact.com/us/products/0201702>

Insulating sleeve, color: green



RIF-2-RPT-LDP-24DC/4X21 AU - Relay Module



2908332

<https://www.phoenixcontact.com/us/products/2908332>

MPS-IH GY - Insulating sleeve

0201728

<https://www.phoenixcontact.com/us/products/0201728>

Insulating sleeve, color: gray



MPS-IH BK - Insulating sleeve

0201731

<https://www.phoenixcontact.com/us/products/0201731>

Insulating sleeve, color: black



RIF-2-RPT-LDP-24DC/4X21 AU - Relay Module



2908332

<https://www.phoenixcontact.com/us/products/2908332>

ZB 5 :UNBEDRUCKT - Zack marker strip

1050004

<https://www.phoenixcontact.com/us/products/1050004>



Zack marker strip, Strip, white, unlabeled, can be labeled with: PLOTMARK, CMS-P1-PLOTTER, mounting type: snapped, for terminal block width: 5.2 mm, lettering field size: 5.1 x 10.5 mm, Number of individual labels: 10

ZB 5 CUS - Zack marker strip

0824962

<https://www.phoenixcontact.com/us/products/0824962>



Zack marker strip, can be ordered: Strip, white, labeled according to customer specifications, mounting type: snap into tall marker groove, for terminal block width: 5.2 mm, lettering field size: 5.15 x 10.5 mm, Number of individual labels: 10

RIF-2-RPT-LDP-24DC/4X21 AU - Relay Module



2908332

<https://www.phoenixcontact.com/us/products/2908332>

ZB 5,LGS:FORTL.ZAHLEN - Zack marker strip

1050017

<https://www.phoenixcontact.com/us/products/1050017>



Zack marker strip, Strip, white, labeled, printed horizontally: consecutive numbers 1 ... 10, 11 ... 20, etc. up to 491 ... 500, mounting type: snapped, for terminal block width: 5.2 mm, lettering field size: 5.15 x 10.5 mm, Number of individual labels: 10

ZB 5,QR:FORTL.ZAHLEN - Zack marker strip

1050020

<https://www.phoenixcontact.com/us/products/1050020>



Zack marker strip, white, Printed vertically: consecutive numbers 1 ... 10, 11 ... 20, etc. up to 491 ... 500, mounting type: snapped, for terminal block width: 5.2 mm, lettering field size: 5.15 x 10.5 mm

RIF-2-RPT-LDP-24DC/4X21 AU - Relay Module



2908332

<https://www.phoenixcontact.com/us/products/2908332>

ZB 5,LGS:GLEICHE ZAHLEN - Zack marker strip

1050033

<https://www.phoenixcontact.com/us/products/1050033>



Zack marker strip, Strip, white, labeled, can be labeled with: CMS-P1-PLOTTER, printed horizontally: Identical numbers 1 or 2, etc. up to 100, mounting type: snapped, for terminal block width: 5.2 mm, lettering field size: 5.15 x 10.5 mm, Number of individual labels: 10

ZB 5,LGS:L1-N,PE - Zack marker strip

1050415

<https://www.phoenixcontact.com/us/products/1050415>



Zack marker strip, Strip, white, labeled, horizontal: L1, L2, L3, N, PE, L1, L2, L3, N, PE, mounting type: snapped, for terminal block width: 5.2 mm, lettering field size: 5.15 x 10.5 mm, Number of individual labels: 10

RIF-2-RPT-LDP-24DC/4X21 AU - Relay Module



2908332

<https://www.phoenixcontact.com/us/products/2908332>

UC-TM 5 - Marker for terminal blocks

0818108

<https://www.phoenixcontact.com/us/products/0818108>



Marker for terminal blocks, Sheet, white, unlabeled, can be labeled with: BLUEMARK ID COLOR, BLUEMARK ID, BLUEMARK CLED, PLOTMARK, CMS-P1-PLOTTER, mounting type: snapped, for terminal block width: 5.2 mm, lettering field size: 4.6 x 10.5 mm, Number of individual labels: 96

UC-TM 5 CUS - Marker for terminal blocks

0824581

<https://www.phoenixcontact.com/us/products/0824581>



Marker for terminal blocks, can be ordered: by sheet, white, labeled according to customer specifications, mounting type: snap into tall marker groove, for terminal block width: 5.2 mm, lettering field size: 10.5 x 4.6 mm, Number of individual labels: 96

RIF-2-RPT-LDP-24DC/4X21 AU - Relay Module



2908332

<https://www.phoenixcontact.com/us/products/2908332>

UCT-TM 5 - Marker for terminal blocks

0828734

<https://www.phoenixcontact.com/us/products/0828734>



Marker for terminal blocks, Sheet, white, unlabeled, can be labeled with: TOPMARK NEO, TOPMARK LASER, BLUEMARK ID COLOR, BLUEMARK ID, BLUEMARK CLED, THERMOMARK PRIME, THERMOMARK CARD 2.0, THERMOMARK CARD, mounting type: snapped, for terminal block width: 5.2 mm, lettering field size: 4.6 x 10.5 mm, Number of individual labels: 72

UCT-TM 5 CUS - Marker for terminal blocks

0829595

<https://www.phoenixcontact.com/us/products/0829595>



Marker for terminal blocks, can be ordered: by sheet, white, labeled according to customer specifications, mounting type: snap into tall marker groove, for terminal block width: 5.2 mm, lettering field size: 4.6 x 10.5 mm, Number of individual labels: 72

RIF-2-RPT-LDP-24DC/4X21 AU - Relay Module



2908332

<https://www.phoenixcontact.com/us/products/2908332>

GBS 5-25X12 - Group marker label for terminal marking

0810588

<https://www.phoenixcontact.com/us/products/0810588>



Group marker label, snaps onto terminal center for screw, spring-cage and quick connection terminal blocks, labeled with a 25 x 12 mm label or manually with the B-STIFT, in the foot part with ZB 5

GBS 5-25X5 - Group marker label for terminal marking

0829126

<https://www.phoenixcontact.com/us/products/0829126>



Group marking label, can be snapped into terminal center for screw, spring-cage, push-in, and fast connection terminal blocks, can be labeled with a 24 x 4 mm label or manually using B-STIFT, in the foot part with ZB 5

RIF-2-RPT-LDP-24DC/4X21 AU - Relay Module



2908332

<https://www.phoenixcontact.com/us/products/2908332>

STP 5-2-ZB - Marker carriers

3037643

<https://www.phoenixcontact.com/us/products/3037643>



Marker carriers, snaps into ST 2,5 spring-cage terminal blocks, can be marked with UC-TM 5, UC-TMF 5, UCT-TM 5, UCT-TMF 5, ZB 5, or ZBF 5, gray, unlabeled, mounting type: snapped

ZB 15:UNBEDRUCKT - Zack marker strip

0811972

<https://www.phoenixcontact.com/us/products/0811972>



Zack marker strip, Strip, white, unlabeled, can be labeled with: PLOTMARK, CMS-P1-PLOTTER, mounting type: snapped, for terminal block width: 15.2 mm, lettering field size: 10.5 x 15.1 mm, Number of individual labels: 5

RIF-2-RPT-LDP-24DC/4X21 AU - Relay Module



2908332

<https://www.phoenixcontact.com/us/products/2908332>

ZB 15 CUS - Zack marker strip

0824945

<https://www.phoenixcontact.com/us/products/0824945>



Zack marker strip, can be ordered: Strip, white, labeled according to customer specifications, mounting type: snap into tall marker groove, for terminal block width: 15.2 mm, lettering field size: 10.5 x 15.1 mm, Number of individual labels: 5

ZB 15,LGS:L1-N,PE - Zack marker strip

0811998

<https://www.phoenixcontact.com/us/products/0811998>



Zack marker strip, Strip, white, labeled, printed horizontally: L1, L2, L3, N, PE, mounting type: snapped, for terminal block width: 15.2 mm, lettering field size: 10.5 x 15.1 mm, Number of individual labels: 5

RIF-2-RPT-LDP-24DC/4X21 AU - Relay Module



2908332

<https://www.phoenixcontact.com/us/products/2908332>

UC-TM 16 - Marker for terminal blocks

0819217

<https://www.phoenixcontact.com/us/products/0819217>



Marker for terminal blocks, Sheet, white, unlabeled, can be labeled with: BLUEMARK ID COLOR, BLUEMARK ID, BLUEMARK CLED, PLOTMARK, CMS-P1-PLOTTER, mounting type: snapped, for terminal block width: 16 mm, lettering field size: 15.45 x 10.5 mm, Number of individual labels: 32

UC-TMF 16 - Marker for terminal blocks

0819262

<https://www.phoenixcontact.com/us/products/0819262>



Marker for terminal blocks, Sheet, white, unlabeled, can be labeled with: BLUEMARK ID COLOR, BLUEMARK ID, BLUEMARK CLED, PLOTMARK, CMS-P1-PLOTTER, mounting type: snapped, for terminal block width: 16 mm, lettering field size: 15.45 x 5.1 mm, Number of individual labels: 32

RIF-2-RPT-LDP-24DC/4X21 AU - Relay Module



2908332

<https://www.phoenixcontact.com/us/products/2908332>

RIF-2-BPT/4X21 - Relay base

2900934

<https://www.phoenixcontact.com/us/products/2900934>



Relay base RIF-2..., for industrial relay with 2 or 4 changeover contacts, Push-in connection, plug-in option for input/interference suppression modules, for mounting on NS 35/7,5

REL-IR4/LDP- 24DC/4X21AU - Single relay

2903670

<https://www.phoenixcontact.com/us/products/2903670>



Plug-in industrial relay with power contacts and additional hard gold plating, 4 changeover contacts, test button, status LED, freewheeling diode, mechanical switching position indicator, polarity: A1+, A2-, coil voltage: 24 V DC

RIF-2-RPT-LDP-24DC/4X21 AU - Relay Module



2908332

<https://www.phoenixcontact.com/us/products/2908332>

RIF-RH-2 - Retaining bracket

2900954

<https://www.phoenixcontact.com/us/products/2900954>



Relay retaining bracket, with ejector function and holder for marking material, suitable for RIF-2 relay base, for industrial relay

Phoenix Contact 2023 © - all rights reserved

<https://www.phoenixcontact.com>

Phoenix Contact USA

586 Fulling Mill Road

Middletown, PA 17057, United States

(+717) 944-1300

info@phoenixcon.com